

2024

Version 1

# ICFMA

INSULATING CONCRETE FORMS  
MANUFACTURERS ASSOCIATION  
[ICF-MA.ORG](http://ICF-MA.ORG)



[QUADLOCK.COM](http://QUADLOCK.COM)



[NUDURA.COM](http://NUDURA.COM)



[SUPERFORMICF.CA](http://SUPERFORMICF.CA)



[ELEMENTICF.COM](http://ELEMENTICF.COM)



[BUILDBLOCK.COM](http://BUILDBLOCK.COM)



[FOXBLOCKS.COM](http://FOXBLOCKS.COM)



ICF BUILDING SYSTEM  
[INTEGRASPEC.COM](http://INTEGRASPEC.COM)



[ALLEGUARD.COM](http://ALLEGUARD.COM)

The Insulating Concrete Forms Manufacturers Association  
Prescriptive ICF Design for Part 9 Structures in Canada  
Second Edition

[LEARN MORE ABOUT ICFS AT ICF-MA.ORG](http://ICF-MA.ORG)

This engineering is only authorized for use by ICFMA Members. ©2024 All Rights Reserved.



# ICFMA

**INSULATING CONCRETE FORMS**  
MANUFACTURERS ASSOCIATION

**The ICFMA Prescriptive ICF Design  
for Part 9 Structures in Canada**  
Second Edition

**INSULATING CONCRETE FORMS**  
MANUFACTURERS ASSOCIATION

# ICFMA

**INSULATING CONCRETE FORMS**  
MANUFACTURERS ASSOCIATION

# The Insulating Concrete Forms Manufacturers Association Prescriptive ICF Design for Part 9 Structures in Canada Second Edition

## Introduction

### Preface

Welcome to the Second Edition of the ICFMA Prescriptive ICF Design Tables for Part 9 Buildings in Canada. The following guideline specifications were developed on behalf of the member companies of the Insulating Concrete Form Manufacturers Association (ICFMA) by Tacoma Engineers Inc. with offices in Ontario, Canada.

### Objective

The objective of this manual is to provide Prescriptive Tables, Engineering Details and ICF product information that is code compliant for buildings constructed under Part 9 of the 2020 National Building Code of Canada. This manual provides code compliant information for Insulating Concrete Forms across each provincial region of Canada and contains a broad scope of residential designs that cover specific nuances of individual provincial regions. Each of the tables and designs cover the standard specifications for products manufactured or produced by members of the ICFMA. This guide is available in both English and French language versions.

### Scope

Design information contained in this guide applies to below-grade and above-grade ICF reinforced concrete walls, both load bearing and non-load bearing, that make up the exterior and/or interior of Part 9 buildings that fall within the limitations of this guide. Floor design/connections and roof design/connections are not covered in this guide and must be designed by others. Any other building component not specifically named in this guide must be designed by others or follow prescriptive provisions contained in the applicable building code. Fire resistance characteristics of ICF/concrete walls are not covered in this guide, but are available from your ICFMA member company upon request.

### Applicability

The tables in this manual are the property of the ICFMA and are specific to products offered by ICFMA member companies. The tables are not authorized for use by non-member ICF manufacturers or non-ICF methods of concrete forming. If specific questions arise about how to design or reference the tables in this manual of an ICFMA members product check with the technical department of that ICFMA member company. For example: Coursing height may vary between 12 inches and 18 inches depending on brand used. Horizontal tie spacing may vary between 6 inches and 12 inches. Product specific nuances may affect how the tables in the guide are used.

Design information contained in this document is limited to use in buildings described in Section 1 "Design Parameters" of the guide, including a maximum number of below-grade and above-grade stories as well as certain building size limitations. While the intent of this guide are the broadest applicability of Canada and it's individual provinces, there are some limits to applicability, including seismic response and wind loading. Building design may be limited by spans, deflection and aspect ratio among others.

**CHECK ALL CONDITIONS THAT APPLY TO YOUR SITE AND BUILDING DESIGN TO ENSURE COMPATIBILITY WITH THE LIMITATIONS STATED IN SECTION 1 OF THIS GUIDE BEFORE PROCEEDING WITH ITS USE.**

## Engineered Design

These tables and specifications have been developed and reviewed against the 2020 National Building Code of Canada and CSA A23.3 by Tacoma Engineers. [www.tacomaengineers.com](http://www.tacomaengineers.com) Tables carry a stamp for all Canadian provinces. Check for a stamp applicable to your province before using or referring to the tables.

Review for code compliance will be carried out as building code and standards versions evolve. Check with your ICF member company for the most current guide version available.

### Errata

All efforts have been made to create a publication free from errors. If ICFMA is notified of or discovers errors, errata will be published and posted on the ICFMA website at [www.icfma.org](http://www.icfma.org).

### Copyright

©2024 Insulating Concrete Form Manufacturers Association  
All rights reserved. No part of this publication may be reproduced, stored in a retrieval system, or transmitted in any form or by any means, electronic, mechanical, photocopying, recording, or otherwise, without the prior permission of the copyright owner.

The Insulating Concrete Form Manufacturers Association (ICFMA) is a not-for-profit trade organization and provides this publication solely for the continuing education of qualified building design and construction professionals. This publication should only be used by qualified professionals who possess all required license(s) in the authority having jurisdiction and who are competent to evaluate the significance and limitations of the information provided herein. Any qualified professional who chooses to use any of the information found in this publication must accept total responsibility for the application of this information. Other readers should obtain assistance from a Qualified Professional before proceeding.

ICFMA and its members make no express or implied warranty with respect to this publication or any information contained herein. No warranty is made of merchantability or fitness for a particular purpose. ICFMA and its members disclaim any product liability (including without limitation any strict liability in tort) in connection with this publication or any information contained herein.

### Acknowledgments

The Insulating Concrete Form Manufacturers Association wishes to express its thanks to the following individuals for their contributions and guidance throughout the process of creating this guide:

Ross Monsour – ICFMA Director  
Robert Schulthorpe – Engineering Consultant  
Nathan Proper – Tacoma Engineers  
Morteza Mehrzadi – Tacoma Engineers  
Jason Unruh – SuperForm ICF  
Dennis Micoff – BuildBlock ICF  
Francis Roma – Logix ICF  
Keven Rector – Nudura ICF  
Douglas Bennion – Quad-Lock ICF  
Kelvin Doerr – Fox Blocks ICF  
Brian Corder – BuildBlock ICF  
Pooja Patel – Amvic ICF

# Structural Design - National and Provincial Codes and Stamps

Tacoma Engineers has completed the structural design of the Insulating Concrete Forms Manufacturers Association (ICFMA) Prescriptive ICF Design Tables for Part 9 Buildings in Canada, in accordance with the 2020 National Building Code of Canada (NBCC).

This design guide is certified for Canadian provinces, as listed below:

Ontario, British Columbia, Alberta, Saskatchewan, Manitoba, Nova Scotia, Prince Edward Island, and New Brunswick.

In addition to the 2020 NBCC, this design guide has also been reviewed and is certified for conformance to the following building codes and regulations:

- Ontario: 2024 Ontario Building Code, effective January 2025
- Nova Scotia: 2020 NBCC adopted by Nova Scotia Building Code, effective April 2025.
- Alberta: 2023 Alberta Building Code as in effect March 2024.
- British Columbia: 2023 British Columbia Building Code as in effect March 2024.
- Manitoba: 2024 Manitoba Building Code as in effect January 2024.
- Saskatchewan: 2020 NBCC Adopted by the Province of Saskatchewan as in effect in January 2024.
- New Brunswick: 2020 NBCC Adopted by the Province of New Brunswick, effective April 2025.
- Prince Edward Island: 2020 NBCC Adopted by the Province of Prince Edward Island on March, 2024.
- Newfoundland and Labrador: 2020 NBCC Adopted by Newfoundland and Labrador Regulation.

**TACOMA**  
ENGINEERS

EXPERIENCE TRUST

STRUCTURAL ENGINEERS

GUELPH - BARRIE - WATERLOO  
[www.tacomaengineers.com](http://www.tacomaengineers.com)

519-763-2000 (Guelph)

This page includes the stamps and seals for these provinces. Due to space limitations, other pages are only stamped with an Ontario stamp.



*Steven Adema*  
Nov. 6, 2024  
P# 8056



TE-42773-23  
24/11/06  
P#P# 1003572

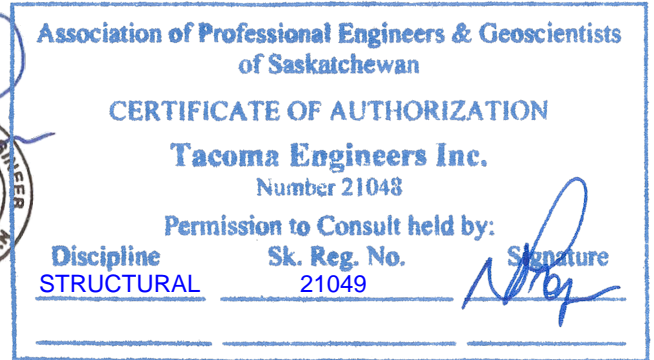
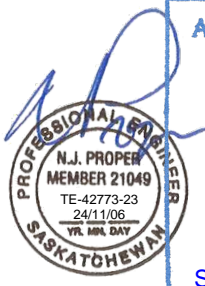
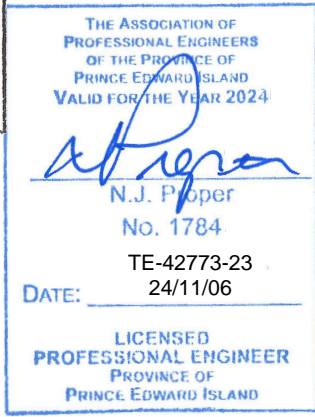
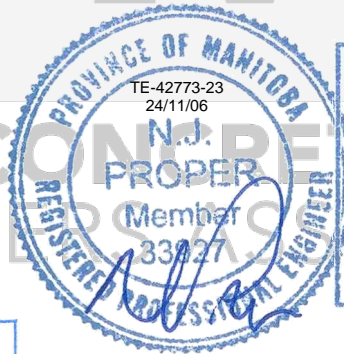
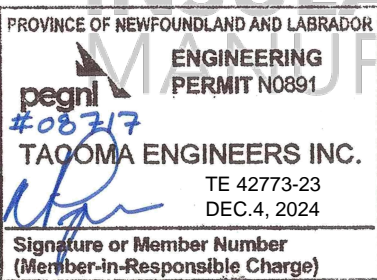

# CONTENTS

|  |     |
|--|-----|
| Design Limitation.....   | 6   |
| 1. Design Parameters.....  | 6   |
| 2. Construction .....  | 7   |
| 3. Concrete .....  | 8   |
| 4. Reinforcing Steel .....   | 8   |
| 5. Above Grade and Below Grade Walls.....  | 9   |
| 5.1. Distributed Reinforcing Steel.....  | 10  |
| 5.2. Shear Walls .....   | 11  |
| 5.3. Concentrated Point Loads on Walls.....  | 12  |
| 5.4. Window and Door Openings .....  | 12  |
| 5.4.1. Lintels .....   | 12  |
| 5.5. Stair Openings.....   | 13  |
| 5.6. Laterally Supported Unreinforced Foundation Wall .....                            | 14  |
| 5.7. Laterally Unsupported Foundation Walls (Knee Wall) with Wood Framing Above.....   | 14  |
| 6. Wood Ledger Connection.....   | 14  |
| 7. Brick Ledge.....  | 15  |
| 8. Strip Footing .....   | 15  |
| List of Details.....   | 17  |
| List of Tables.....  | 18  |
| Below & Above Grade Walls Details and Tables .....                                     | 22  |
| Lintel Details and Tables.....   | 95  |
| Concentrated Point Load Table .....  | 122 |
| Stair Opening Tables .....   | 123 |
| Laterally Supported Foundation Wall Detail and Table .....                             | 126 |
| Laterally Unsupported Foundation Wall Detail and Table .....                           | 127 |
| Ledger Connection Detail and Table .....   | 129 |
| Brick Ledge Detail and Table .....   | 130 |
| Footings Details and Tables .....  | 132 |
| Appendix A. Equivalent Spectral Response Acceleration for ICF Walls, $S_{a,ICF}$ ..... | 136 |
| Appendix B. Climatic Design Data .....   | 139 |

# Design Limitation

The design tables included in this manual were determined based on the parameters provided in this section. These tables cannot be used if the proposed construction does not meet all the parameters provided in this section or in the tables.

## 1. Design Parameters

- 1.1. These tables only apply to residential buildings conforming to Part 9 of the 2020 National Building Code of Canada (NBCC).
- 1.2. If the proposed construction does not meet the design or applicability of parameters noted herein, a local design professional shall be retained to prepare the design in accordance with applicable standards.
- 1.3. This design manual applies only to flat ICF walls (concrete core of uniform thickness). All walls must line up vertically.
- 1.4. In case this document conflicts with design codes, standards and building regulations, the code provisions shall apply.
- 1.5. The design and construction of all work shall conform to the latest editions of the NBCC, the local building code, local regulations and bylaws and the occupational health and safety act.
- 1.6. These tables have been designed to resist gravity, wind and earthquake forces in accordance with the 2020 NBCC for the criteria indicated in the design limitations and in the design tables.
- 1.7. Design is limited to one (1) floor below grade and a maximum of two (2) stories above grade.
- 1.8. The maximum building dimensions are:

|                                      |                    |                      |
|--------------------------------------|--------------------|----------------------|
| Building Area                        | 300 m <sup>2</sup> | 3200 ft <sup>2</sup> |
| Maximum Building Dimension           | 24.4 m             | 80 ft                |
| Building Aspect Ratio (Length:Width) |                    |                      |
| $S_{a,ICF} \leq 0.16$                | 2.5:1              |                      |
| $S_{a,ICF} > 0.16$                   | 2:1                |                      |
| Roof Clear Span                      | 12.2 m             | 40 ft                |
| Floor Clear Span                     | 7.32 m             | 24 ft                |
| Second Floor Wall Height             | 3.05 m             | 10 ft                |
| Main Floor Wall Height               | 4.88 m             | 16 ft                |
| Foundation Wall Height               | 3.66 m             | 12 ft                |

Note:  $S_{a,ICF}$  is the equivalent spectral response acceleration for ICF walls, provided in Appendix A.

1.9. The maximum unfactored gravity loads are:

|                      |                        |                        |
|----------------------|------------------------|------------------------|
| Roof Snow            | 4.0 kPa                | 84 psf                 |
| Floor Live           | 1.9 kPa                | 40 psf                 |
| Roof Dead            | 0.7 kPa                | 15 psf                 |
| Floor Dead           | 0.7 kPa                | 15 psf                 |
| Concrete Density     | 23.6 kN/m <sup>3</sup> | 150 lb/ft <sup>3</sup> |
| Brick Veneer Density | 20.0 kN/m <sup>3</sup> | 128 lb/ft <sup>3</sup> |

1.10. The lateral soil pressures against below grade walls are:

|  |                              |             |
|--|------------------------------|-------------|
| Area Surcharge (K <sub>o</sub> = 0.5)                  | 2.4 kPa                      | 50 psf      |
| Equivalent Fluid Density of Soil (K <sub>o</sub> =1.0) | 480 – 1200 kg/m <sup>3</sup> | 30 – 75 pcf |

1.11. The wind loads are indicated in the design tables.

1.12. Seismic limits in wall analysis and design are based on S<sub>a</sub> (0.2) and S<sub>a</sub> (0.5) values. In order to simplify the tables, an equivalent seismic spectral response acceleration for ICF walls, S<sub>a,ICF</sub> is defined and provided in Appendix A. Equivalent spectral response, S<sub>a,ICF</sub>, is the ratio of seismic base shear to the building weight for a site class “D” as given in following equation and the limits are indicated in shear wall tables.

$$S_{a,ICF} = V_{seismic} / W$$

A professional engineer must design the ICF walls for locations where the S<sub>a,ICF</sub> is not provided in Appendix A.

1.13. The following peak ground acceleration (PGA) data was used in the analysis of below grade walls. These are the maximum associated values from Climatic Data of the 2020 NBCC for the selected S<sub>a,ICF</sub> values.

|                    |      |      |      |      |
|--------------------|------|------|------|------|
| S <sub>a,ICF</sub> | 0.11 | 0.16 | 0.31 | 0.79 |
| PGA                | 0.15 | 0.24 | 0.49 | 1.21 |

1.14. Only seismic site classes A, B, C and D, as defined in Part 4 of the NBCC, are permitted.

1.15. Wall and lintel deflections have been limited to L/360.

1.16. The maximum building aspect ratio is the longest plan dimension divided by the shortest plan dimension of the building. Attached garages can be excluded from the aspect ratio calculation provided they are separated from the main building by ICF walls meeting the requirements of this guide.

## 2. Construction

2.1. Except as noted otherwise for specific conditions, the design assumes that ALL walls are laterally supported by the building foundation, roof and floor systems, designed by others. Roof and floor systems can be designed in accordance with part 9 of NBCC or building system manufacturers.

2.2. Foundation walls shall be laterally supported at the top and bottom prior to backfilling.

- 2.3. Provide lateral support at the bottom of the foundation wall in accordance with NBCC 2020 part 9.15.4.4. Alternatively, dowel the wall to the footing as per Table F. 1.
- 2.4. The contractor shall make adequate provision for construction loads and temporary bracing to keep the structure plumb and in true alignment at all phases of construction.
- 2.5. Hydrostatic pressure due to water build-up has not been included in the design and analysis. Backfill shall be drained in accordance with NBCC 2020 9.4.4.6.
- 2.6. Surface grading around the foundation is to slope away from building to allow surface water to drain away.
- 2.7. Provide adequate frost protection for all foundation walls and footings, both during construction and in the final installation.
- 2.8. Construction joints shall be made and located so as not to impair the strength of the structure. All specified reinforcing bars shall have minimum lap lengths across all construction joints.
- 2.9. Construction joints shall not be installed within 610 mm (2ft) of a wall opening.
- 2.10. All dimensions are in millimeters unless noted otherwise.
- 2.11. It is the responsibility of the roof and floor designer to ensure adequate bearing for all framing members is provided on the concrete walls.

### **3. Concrete**

- 3.1. Concrete work shall conform to the latest editions of CSA A23.1,2,3 for materials and workmanship.
- 3.2. The minimum 28-day compressive strength of concrete shall be 25 MPa, for 6" thick walls and 20 MPa for other walls.
- 3.3. Maximum size of aggregates in concrete walls with minimum concrete cover of 40mm, are to be 19mm (3/4") diameter. Maximum aggregate size shall be limited to 12.5mm (1/2") if the concrete cover is less than 40mm.
- 3.4. Concrete pours shall be terminated at locations of lateral support.
- 3.5. Use high frequency vibration to place all concrete. Extra care is needed when vibrating during concrete placement for the purpose of ensuring a homogenous aggregate distribution, without segregation.
- 3.6. Take adequate measures to protect concrete from exposure to freezing temperatures and precipitation at least seven days after concrete placement.

### **4. Reinforcing Steel**

- 4.1. Use Grade 400 deformed rebar placed in accordance with the manual of standard practice.
- 4.2. Reinforcement size, spacing and placement to be in accordance with notes and design tables for above grade walls, below grade walls and lintels.
- 4.3. 10M bars may be installed as distributed steel where 15M bars are specified provided they are installed at half the spacing required for 15M bars. 15M bars may be installed as distributed steel where 10M bars are specified, but must be installed at the same spacing as specified for the 10M bars.
- 4.4. Maintain a minimum concrete clear cover and reinforcement spacing of 40mm (1 1/2") for all reinforcing steel, except 20mm (3/4") cover is permitted for below grade walls of heated buildings. The minimum concrete covers must be maintained for vertical bars in below grade walls.

4.5. Where bars within a lintel cannot achieve a minimum concrete side cover and spacing of 40mm (1½"), the bars are required to be bundled. The following notes apply to all bundled bars:

- a) Groups of parallel reinforcing bars bundled in contact, assumed to act as a unit, with not more than four in any one bundle, may be used. Bundled bars shall be tied, wired, or otherwise fastened together to ensure that they remain in position.
- b) Bundled bars shall not be spliced over the span of any lintel.

4.6. Minimum bar lap length shall be:

- a) 450 mm (18") for 10M bars
- b) 650 mm (26") for 15M bars
- c) 750 mm (30") for 20M bars

4.7. Standard hook lengths shall be:

- a) 200 mm (8") for 10M bars
- b) 250 mm (10") for 15M bars
- c) 300 mm (12") for 20M bars

4.8. Maximum transverse spacing (gap) between non-contact parallel bars spliced by lap splices, shall not exceed the lesser of one-fifth of the required lap splices length or 150mm.

4.9. Guidance was taken from PCA 100-2017 Prescriptive Design of Exterior Walls for One- and Two-Family Dwellings where steel reinforcement does not meet the minimum requirements of CSA A23.3 Clause 14.1. References to research conducted by PCA for these conditions are included in PCA 100-2017.

4.10. Where the vertical wall reinforcement spacing exceeds maximum spacing requirements according to CSA A23.3 Clause 14.1 the design capacity is at least one third more than required.

4.11. Horizontal temperature and shrinkage reinforcing steel may be less than specified in CSA A23.3. This is due to ideal curing conditions within the ICF system, which reduce the risk of cracking. In addition, finishes are not applied directly to the concrete wall; therefore, the risk of potential cracks propagating to the surface of the finishes is minimized.

## 5. Above Grade and Below Grade Walls

5.1. Wall thicknesses given in above and below grade wall tables are the nominal thicknesses. The actual thickness of the wall may vary by ± ¼".

5.2. Above grade and below grade walls are designed to resist out-of-plane and in-plane loads by providing the specified reinforcing steel.

5.3. Provide horizontal and vertical distributed steel throughout all walls as described in the Distributed Reinforcing Steel section.

5.4. Provide additional concentrated horizontal and vertical steel around door and window openings, beside stair openings, under point loads, and at the ends of all walls and at all corners as described in the Window and Door Openings, Stair Openings, Concentrated Point Loads and Shear Walls sections.

- 5.5. The specified reinforcing is applicable to building with walkout basements. However, the global slope stability and building stability for unbalance soil pressures created by the walkout condition is by others.
- 5.6. Provide 600 mm (24") × 600 mm (24") horizontal bent dowel at each corner of the walls. Size and spacing of the dowel should match the horizontal reinforcement as per above and below grade tables.

## 5.1. Distributed Reinforcing Steel

- 5.1.1. Horizontal reinforcing is to consist of 10M or 15M continuous bars at 300 mm (12") o.c. to 900mm (36") o.c., in accordance with the tables.
- 5.1.2. Provide one continuous horizontal bar at maximum 150mm (6") from the top of the wall and at all floor levels.
- 5.1.3. Tables B. 1. 1, B. 2. 1, B. 3. 1 and B. 4. 1 provide the necessary distributed vertical steel to resist the out-of-plane loads for below grade ICF walls with 6" tie spacing.
- 5.1.4. Tables B. 1. 2, B. 2. 2, B. 3. 2 and B. 4. 2 provide the necessary distributed vertical steel to resist the out-of-plane loads for below grade ICF walls with 8" tie spacing.
- 5.1.5. Tables A. 1. 1 and A. 2. 1 provide the necessary distributed vertical steel to resist the out-of-plane loads for above grade ICF walls with 6" tie spacing.
- 5.1.6. Tables A. 2. 1 and A. 2. 2 provide the necessary distributed vertical steel to resist the out-of-plane loads for above grade ICF walls with 8" tie spacing.
- 5.1.7. Interpolation within the tables is not permitted.
- 5.1.8. Any table may be used where the local wind and seismic design values do not exceed the maximum values given in the table.
- 5.1.9. All basement walls in a building with a walkout condition shall be reinforced as a below grade wall for the maximum backfill height. Place the reinforcing in the center of the wall where the basement wall does not support any backfill.
- 5.1.10. The vertical distributed reinforcing bar spacing given in millimeters in the tables is the nominal dimension, the bar spacing in inches is the exact dimension. The vertical bar spacing is given as multiples of the form web spacing.
- 5.1.11. For walls below grade, the vertical reinforcing is to be placed on the inside face of the wall as shown in Detail B. 1.
- 5.1.12. For walls above grade, the vertical reinforcing is to be placed in the middle of the wall as shown in Detail A. 1.
- 5.1.13. Walls above grade formed using 300mm (12") forms shall have all distributed steel placed in two equal layers. One layer is to be placed in the exterior third of the wall and the other layer in the interior third of the wall as shown in Detail A. 2.
- 5.1.14. The height of an above grade wall is the distance from the top of the floor connection at its base to the bottom of the floor or roof connection at its top, as shown in Detail A. 12.
- 5.1.15. The height of a below grade wall is the distance from the top of the basement floor slab to the point of bearing for the floor system, as shown in Detail A. 12.
- 5.1.16. Backfill height against a below grade wall is the distance from the top of the basement floor slab to the finished exterior grade level.

- 5.1.17. Alternating horizontal bar spacing of 12" o.c. and 24" o.c. may be used to achieve an average spacing of 18" o.c. where 18" o.c. spacing is specified for horizontal bars as shown in Detail A. 3.
- 5.1.18. Provide three horizontal bars in every two rows of 18" high block to achieve an average spacing of 12" o.c. where 12" spacing o.c. is specified for horizontal bars as shown in Detail A. 4.
- 5.1.19. Provide four horizontal bars in every three rows of 16" high block to achieve an average spacing of 12" o.c. where 12" spacing o.c. is specified for horizontal bars as shown in Detail A. 5.
- 5.1.20. Alternating vertical bar spacing of 8" o.c. and 16" o.c. may be used to achieve an average spacing of 12" o.c. where 12" o.c. spacing is specified for vertical bars as shown in Detail A. 6.
- 5.1.21. Distributed reinforcing in a wall shall not be less than that required for the wall above.

## 5.2. Shear Walls

- 5.2.1. Shear walls are solid ICF wall segments between openings and corners.
- 5.2.2. Openings 150mm (6") in diameter and less are permitted within a shear wall, provided they do not occur within 300mm (12") of the ends of the shear wall.
- 5.2.3. Shear walls are designed for buildings with or without walkout basement. Wall configurations for building without and with walkout basement are shown in Detail A. 7 and Detail A. 8, respectively. Wall configurations for walkout basement walls are shown in Detail A. 9.
- 5.2.4. A minimum number and length of shear walls is required on all four sides of the building on all levels as specified in shear wall tables (A.3 3200 to A.11 800) for above-grade walls where the building area is less than or equal to 3200 ft<sup>2</sup>.

This is to replace the requirements for 100 mm (4'-0") long wall segments at each corner in exterior walls specified in NBCC 9.20.17.2. (1) and 9.20.17.4. (1).

These Tables are designated by area overall of the building footprint as follows:

- Use Tables A.3 3200 to A.11 3200 for building areas between 2,401 sf through 3,200 sf
- Use Tables A.3.2400 to A.11 2400 for building areas between 1,601 sf through 2,400 sf
- Use Tables A.3 1600 to A.11 1600 for building areas between 801 sf through 1,600 sf
- Use Tables A.3. 800 to A.11. 800 for building area 800 sf and under.

- 5.2.5. Below grade walls shall have the same number and length of shear walls as required for the walls immediately above.
- 5.2.6. All walls shall be proportionally and evenly distributed in both the transverse and longitudinal direction of the building.
- 5.2.7. Two 15M full height vertical reinforcing bars are to be installed at the ends of all required shear walls in accordance with Detail A. 10. These bars are referred to as concentrated reinforcement and are in addition to the distributed reinforcement specified elsewhere.
- 5.2.8. Matching dowels are to be provided for the concentrated and distributed vertical reinforcement at the base of all required shear walls into floor below as shown in Detail A. 11.
- 5.2.9. Horizontal reinforcement in shear walls where  $S_{a,ICF} > 0.16$  shall be terminated at the ends of the wall with a standard hook.

### 5.3. Concentrated Point Loads on Walls

- 5.3.1. All point loads, such as concentrated loads created by girder trusses, columns and beams, shall bear directly on top of the concrete wall, and shall not be hung or in any other manner create an eccentric loading on the concrete wall. Provide beam pockets, as necessary.
- 5.3.2. The minimum length of solid wall without openings directly below point loads, such as concentrated loads created by girder trusses, columns and beams, shall be 6'-0". In addition to the wall reinforcing required in the following tables, two additional 15M vertical bars shall be installed directly below the point load. This length of solid wall may contain a corner.
- 5.3.3. Use Table C. 1 for the maximum unfactored point load that can be applied on a solid wall without opening if length of the wall is less than 6'-0".
- 5.3.4. Maximum un-factored point loads given in Table C. 1 are only the wall capacity. It is the responsibility of the roof and floor designer to ensure adequate bearing for all framing members is provided on the concrete walls.

### 5.4. Window and Door Openings

- 5.4.1. The cumulative width of openings in above grade walls shall not be more than 70% of the total wall length.
- 5.4.2. The cumulative width of openings in below grade walls shall not be more than 25% of the total wall length.
- 5.4.3. Openings in below grade walls shall not exceed a maximum width of 1.83m (6'-0") and a maximum height of 0.914m (3'-0").
- 5.4.4. The length of solid wall between two openings in below grade walls shall be equal to the average width of the openings and at least 1.22m (4'-0").
- 5.4.5. A minimum of 2-10M bars is to be installed completely around all sides of openings.
- 5.4.6. Provide additional horizontal reinforcing steel directly above the opening as required for lintels.
- 5.4.7. Horizontal bars above and below the opening shall extend a minimum of 610mm (24") past opening.
- 5.4.8. Vertical bars on each side of the opening shall extend the full height of the wall.
- 5.4.9. Distributed vertical reinforcing steel that is interrupted by an opening shall be replaced by an equal amount of concentrated vertical reinforcing steel with half placed on each side of the opening. The additional steel is to be evenly distributed within a distance equal to half the opening width, up to a maximum of 1.22m (4'-0"), from each side of the opening.
- 5.4.10. If the spacing of the additional concentrated vertical reinforcing required on each side of openings, described in the previous note, is less than 150mm (6"), a local design professional shall be retained to prepare the design in accordance with applicable standards.
- 5.4.11. Provide additional vertical reinforcing at the sides of openings as required at the ends of shear walls.

#### 5.4.1. Lintels

- 5.4.1.1. All concrete wall segments above openings are to be considered lintels.
- 5.4.1.2. The top of all lintels is to be laterally supported by the roof and floor systems, designed by others.
- 5.4.1.3. Lintels shall be a minimum of 200mm (8") deep.

- 5.4.1.4. Lintel bottom reinforcing is to be installed a maximum of 89mm (3½") from the bottom of the lintel and is to extend a minimum of 610mm (24") past the wall opening.
- 5.4.1.5. A minimum of 2-10M bars is to be installed completely around all sides of openings, as shown in Detail L. 1.
- 5.4.1.6. Where stirrups are required for lintels with uniformly distributed load, they shall be single 10M hook stirrups installed around bottom and top bars over the given end distance at each side of the beam as shown in Detail L. 2.
- 5.4.1.7. Where stirrups are required for lintels with concentrated load, they shall be single 10M hook stirrups installed around bottom and top bars over the whole length of the beam. 5.4.1.4.
- 5.4.1.8. Minimum lintel reinforcing is to consist of bottom bars indicated in the design tables, along with horizontal 10M continuous wall reinforcing at 406mm (16") on center, and a minimum of 1-10M top bar located 50mm (2") from the top of the lintel, as shown in Detail L. 3.
- 5.4.1.9. Provide a minimum of three stirrups in all lintels at the spacing indicated in the tables when  $S_{a,ICF} > 0.16$ .
- 5.4.1.10. The lintel design tables are only applicable for uniformly distributed gravity line loads and point loads, such as concentrated loads created by girder trusses, columns and beams.
- 5.4.1.11. Concentrated load lintel tables consider only a single concentrated load acting on anywhere along the lintel span.
- 5.4.1.12. The lintel tables do not consider uniform and concentrated load to act simultaneously on the lintel.
- 5.4.1.13. The uniformly distributed load (UDL) is calculated by multiplying the roof and/or floor loads, including snow load (SL), live load (LL) and dead load (DL), by the tributary width (TW) of the roof and/or floor. The tributary width is determined by adding half the span of each rafter/joist bearing on the concrete lintel. For example, the UDL for a lintel supporting floor joists spanning 10'-0" and roof trusses spanning 30'-0" on one side only is calculated as follows:
- $$UDL = TW_{FLOOR} * (LL_{FLOOR} + DL_{FLOOR}) + TW_{ROOF} * (SL_{ROOF} + DL_{ROOF})$$
- $$UDL = (10 \text{ ft}/2) * (40 \text{ psf} + 15 \text{ psf}) + (30 \text{ ft}/2) * (84 \text{ psf} + 15 \text{ psf})$$
- $$UDL = 275 \text{ lbs}/\text{ft} + 1485 \text{ lbs}/\text{ft} = 1760 \text{ lbs}/\text{ft}$$
- 5.4.1.14. The weight of walls above the lintel has been included in the design of the lintel tables and does not need to be added to the UDL calculated as described above.
- 5.4.1.15. Where there is less than 305mm (12") of wall between openings, the lintel shall be reinforced to span over both openings, as shown in Detail L. 4.
- 5.4.1.16. Where there is less than 610mm (24") of wall between openings, and openings are greater than 1.53m (5'-0") in length, the lintel shall be reinforced to span over both openings, as shown in Detail L. 5.

## 5.5. Stair Openings

- 5.5.1. Additional reinforcement is to be provided in exterior walls where a stair opening interrupts the required lateral support provided by the floor framing.
- 5.5.2. Table A. 12. provides the maximum dimension of stair opening parallel to the wall and the required horizontal reinforcement of above grade walls at stair opening.
- 5.5.3. Table B. 5. provides the maximum dimension of stair opening parallel to the wall and the required horizontal reinforcement of below grade walls at stair opening. Below grade walls at stair openings are designed for a backfill equivalent fluid density of 480 kg/m<sup>3</sup> and a maximum  $S_a(0.2)$

of 0.7. Reinforcement design of below grade walls at stair openings shall be reviewed by a professional engineer if the wall does not meet the requirement of this table.

- 5.5.4. Lateral restraint of the wall is to be provided by the floor framing on each side of the stair opening, by others.
- 5.5.5. The spacing of distributed vertical reinforcement is to be reduced for a distance of 1.22m (4'-0") on each side of the stair opening for above grade and below grade walls. The required spacing is calculated by the following equation and listed in Table A. 13.

$$S_{\text{REDUCED}} = 2.44 / (L_{\text{UNSUPPORTED}} + 2.44) * S_{\text{TABLES}} \quad (\text{METRIC})$$

$$S_{\text{REDUCED}} = 8 / (L_{\text{UNSUPPORTED}} + 8) * S_{\text{TABLES}} \quad (\text{IMPERIAL})$$

where

$S_{\text{REDUCED}}$  = the bar spacing (mm/in) required at the sides of the stair opening.

$S_{\text{TABLES}}$  = the required bar spacing (mm/in) for a laterally supported wall as determined from above grade and below grade walls tables.

$L_{\text{UNSUPPORTED}}$  = the length of wall (m/ft) that is laterally unsupported as a result of a stair opening in the floor framing.

- 5.5.6. If the stair opening is out of the scope of design limitations for stair opening table, additional distributed horizontal reinforcing bars are to be added at the stair opening as specified by a professional engineer.

## 5.6. Laterally Supported Unreinforced Foundation Wall

- 5.6.1. Foundation walls in this section are designed for backfill equivalent fluid density of 480 kg/m<sup>3</sup> in accordance with section 9.4.4.6 of NBCC 2020.
- 5.6.2. If the foundation wall is laterally supported at the top (e.g. by floor joists) and meets all the requirements of NBCC 2020 section 9.15.4, and supports only wood frame construction above, a 20 MPa unreinforced concrete wall is adequate for the specific wall and backfill height, as per NBCC 2020 table 9.15.4.2.A, shown in Detail B. 2.

- 5.6.3. Use below grade wall tables if the height of the wall and / or backfilled soil is greater than the maximum values of Table B. 6.

- 5.6.4. Use below grade wall tables for walls supporting ICF wall above.

## 5.7. Laterally Unsupported Foundation Walls (Knee Wall) with Wood Framing Above

- 5.7.1. If the foundation wall is not supported at the top (e.g. by floor joists) and supports only wood frame construction above, the design can follow the knee wall design as shown in Details B.3 and B.4. The design includes both the footing sizing and reinforcing of the footing and wall.
- 5.7.2. If heights of backfilled soil and / or foundation wall are greater than what shown in these details, reinforcement design of the wall must be reviewed by a professional engineer.
- 5.7.3. Foundations are to bear directly on material suitable for 75 kPa (1566 psf) bearing pressure.

## 6. Wood Ledger Connection

- 6.1. Anchor bolts are designed to transfer vertical load of floor to the ICF wall. Design of floor diaphragm by others.

- 6.2. Design loads are 40psf (1.9 kPa) floor live load, 15psf (0.7 kPa) floor dead load.
- 6.3. Anchor bolts are to be staggered as shown in Detail C. 1. Use Table C. 2. for size and spacing of the anchors.

## 7. Brick Ledge

- 7.1. The concrete ledge is to support uniformly distributed loads only. It is not to support concentrated load. A brick ledge section is shown in Detail C. 2.
- 7.2. Table C. 3. provide the brick ledge capacity as the total height of brick veneer or tributary width of a floor that can be supported per unit length of the brick ledge.
- 7.3. The capacity given in Table C. 3. is only for the capacity of the brick ledge. The veneer height may be limited by other building code requirement or manufacturer's installation requirements.
- 7.4. The above grade and below grade wall reinforcing tables include the effects of using the ledge to support floor framing.
- 7.5. The below grade wall reinforcing tables include the effects of using the ledge to support masonry veneer.
- 7.6. The maximum brick height given does not account for windows. To include the effect of windows, it is necessary to calculate an effective brick height.
- 7.7. The ledge reinforcement is 10M hooked rebar, as shown in Detail C. 2 or FOXBLOCKS xLerator as shown in Detail C. 3. It is to be placed 6" or 8" on center matching the tie spacing of ICF blocks.

## 8. Strip Footing

- 8.1. Tables F. 2. to F. 4. provide minimum width and thickness of footing for different loadings and soil bearing pressures.
- 8.2. Soft areas uncovered during excavation shall be sub-excavated to sound material and filled with clean and free drained granular soil.
- 8.3. Protect soil from freezing adjacent to and below all footings.
- 8.4. All footings are to be reinforced with 2-15M continuous bars, as per Detail F. 1.
- 8.5. Tables F. 2. to F. 4. do not include masonry veneer. Increase the footing width by 2" and the thickness by 1" for:
  - a. Every 12'-0" of masonry veneer for 3000psf soil bearing capacity.
  - b. Every 10'-0" of masonry veneer for 2500psf soil bearing capacity.
  - c. Every 8'-0" of masonry veneer for 2000psf soil bearing capacity.
  - d. Every 6'-0" of masonry veneer for 1500psf soil bearing capacity.
- 8.6. The footing size for locations with  $S_a(0.2) > 0.4$  to be the larger of 30" wide by 12" deep or the size shown in the table.
- 8.7. Provide footing dowels as shown in Detail F. 1.
- 8.8. Footing dowels are 10M or 15M bars embedded 6" or 8" into the footing. Dowels size and spacing is given in Table F. 1.

- 8.9. Provide bent dowels as per Note. 4 of Table F. 1, at shear walls locations matching the size and spacing of vertical bars of the shear walls.

**ICFMA**

**INSULATING CONCRETE FORMS  
MANUFACTURERS ASSOCIATION**

## List of Details

|  |     |
|--|-----|
| Detail B. 1. Below Grade Wall Reinforcing Placement for All Wall Thicknesses.....  | 22  |
| Detail A. 1. Above Grade Wall Reinforcing Placement for 6", 8" And 10" Thick Walls.....  | 23  |
| Detail A. 2. Above Grade Wall Reinforcing Placement for 12" Thick Walls.....   | 24  |
| Detail A. 3. Alternating Horizontal Bar Spacing of 12" O.C. and 24" O.C. to Achieve an Average Spacing of 18" O.C. (Two Horizontal Bars in Every Three Rows of ICF Blocks) ..... | 25  |
| Detail A. 4. Three Horizontal Bars in Every Two Rows of 18" High Block to Achieve an Average Spacing of 12" O.C.....   | 25  |
| Detail A. 5. Four Horizontal Bars in Every Three Rows of 16" High Block to Achieve an Average Spacing of 12" O.C.....  | 26  |
| Detail A. 6. Alternating Vertical Bar Spacing of 8" O.C. and 16" O.C. to Achieve an Average Spacing of 12" O.C. (Two Vertical Bars in Every Three Cells) .....                   | 26  |
| Detail A. 7. Wall Configurations in a Building Without Walkout Basement.....   | 27  |
| Detail A. 8. Wall Configurations in a Building with Walkout Basement.....  | 29  |
| Detail A. 9. Walkout Basement Wall Configurations.....   | 32  |
| Detail A. 10. Shear Wall Distributed and Concentrated Vertical Reinforcing Placement.....  | 36  |
| Detail A. 11. Shear Wall Dowels.....   | 37  |
| Detail A. 12. Above and Below Grade Wall Height.....   | 38  |
| Detail L. 1. Reinforcing Around Openings.....  | 95  |
| Detail L. 2. Lintel Stirrup Detail.....  | 96  |
| Detail L. 3. Lintel Section .....  | 96  |
| Detail L. 4. Lintel Span with Less Than 305mm (12") of Wall Between Openings.....  | 97  |
| Detail L. 5. Lintel Span with Less Than 610mm (24") of Wall Between Openings, and Openings Are Greater Than 1.53m (5'-0") in Length.....   | 97  |
| Detail B. 2. Laterally Supported Foundation Wall.....  | 126 |
| Detail B. 3. Laterally Unsupported Foundation Wall (Knee Wall).....  | 127 |
| Detail B. 4. Laterally Unsupported Foundation Wall (Knee Wall) with Brick Veneer.....  | 128 |
| Detail C. 1. Wood Ledger Connection .....  | 129 |
| Detail C. 2. Brick Ledge Connection .....  | 130 |
| Detail C. 3. FOXBLOCKS xLerator Ledge Reinforcement .....  | 130 |
| Detail F. 1. Footing Dowel.....  | 132 |

## List of Tables

|   |    |
|---|----|
| Table B.1.1.– Below Grade Wall Distributed Reinforcement for Seismic Zone Classification, $S_{a,ICF} \leq 0.11$ and Hourly Wind Pressure, $q_{1/50} \leq 1.05kPa$ , for ICF Walls with 6” Tie Spacing.....                    | 39 |
| Table B.1.1. Continued – Below Grade Wall Distributed Reinforcement for Seismic Zone Classification, $S_{a,ICF} \leq 0.11$ and Hourly Wind Pressure, $q_{1/50} \leq 1.05kPa$ , for ICF Walls with 6” Tie Spacing .....        | 40 |
| Table B.1.2.– Below Grade Wall Distributed Reinforcement for Seismic Zone Classification, $S_{a,ICF} \leq 0.11$ and Hourly Wind Pressure, $q_{1/50} \leq 1.05kPa$ , for ICF Walls with 8” Tie Spacing.....                    | 41 |
| Table B.1.2. Continued – Below Grade Wall Distributed Reinforcement for Seismic Zone Classification, $S_{a,ICF} \leq 0.11$ and Hourly Wind Pressure, $q_{1/50} \leq 1.05kPa$ , for ICF Walls with 8” Tie Spacing .....        | 42 |
| Table B.2.1. – Below Grade Wall Distributed Reinforcement for Seismic Zone Classification, $0.11 < S_{a,ICF} \leq 0.16$ and Hourly Wind Pressure, $q_{1/50} \leq 1.05kPa$ , for ICF Walls with 6” Tie Spacing.....            | 43 |
| Table B.2.1. Continued – Below Grade Wall Distributed Reinforcement for Seismic Zone Classification, $0.11 < S_{a,ICF} \leq 0.16$ and Hourly Wind Pressure, $q_{1/50} \leq 1.05kPa$ , for ICF Walls with 6” Tie Spacing ..... | 44 |
| Table B.2.2. – Below Grade Wall Distributed Reinforcement for Seismic Zone Classification, $0.11 < S_{a,ICF} \leq 0.16$ and Hourly Wind Pressure, $q_{1/50} \leq 1.05kPa$ , for ICF Walls with 8” Tie Spacing.....            | 45 |
| Table B.2.2. Continued – Below Grade Wall Distributed Reinforcement for Seismic Zone Classification, $0.11 < S_{a,ICF} \leq 0.16$ and Hourly Wind Pressure, $q_{1/50} \leq 1.05kPa$ , for ICF Walls with 8” Tie Spacing ..... | 46 |
| Table B.3.1. – Below Grade Wall Distributed Reinforcement for Seismic Zone Classification, $0.16 < S_{a,ICF} \leq 0.31$ and Hourly Wind Pressure, $q_{1/50} \leq 1.05kPa$ , for ICF Walls with 6” Tie Spacing.....            | 47 |
| Table B.3.1. Continued – Below Grade Wall Distributed Reinforcement for Seismic Zone Classification, $0.16 < S_{a,ICF} \leq 0.31$ and Hourly Wind Pressure, $q_{1/50} \leq 1.05kPa$ , for ICF Walls with 6” Tie Spacing ..... | 48 |
| Table B.3.2. – Below Grade Wall Distributed Reinforcement for Seismic Zone Classification, $0.16 < S_{a,ICF} \leq 0.31$ and Hourly Wind Pressure, $q_{1/50} \leq 1.05kPa$ , for ICF Walls with 8” Tie Spacing.....            | 49 |
| Table B.3.2. Continued– Below Grade Wall Distributed Reinforcement for Seismic Zone Classification, $0.16 < S_{a,ICF} \leq 0.31$ and Hourly Wind Pressure, $q_{1/50} \leq 1.05kPa$ , for ICF Walls with 8” Tie Spacing .....  | 50 |
| Table B.4.1. – Below Grade Wall Distributed Reinforcement for Seismic Zone Classification, $0.31 < S_{a,ICF} \leq 0.79$ and Hourly Wind Pressure, $q_{1/50} \leq 1.05kPa$ , for ICF Walls with 6” Tie Spacing.....            | 51 |
| Table B.4.1. Continued– Below Grade Wall Distributed Reinforcement for Seismic Zone Classification, $0.31 < S_{a,ICF} \leq 0.79$ and Hourly Wind Pressure, $q_{1/50} \leq 1.05kPa$ , for ICF Walls with 6” Tie Spacing .....  | 52 |
| Table B.4.2. – Below Grade Wall Distributed Reinforcement for Seismic Zone Classification, $0.31 < S_{a,ICF} \leq 0.79$ and Hourly Wind Pressure, $q_{1/50} \leq 1.05kPa$ , for ICF Walls with 8” Tie Spacing.....            | 53 |
| Table B.4.2. Continued– Below Grade Wall Distributed Reinforcement for Seismic Zone Classification, $0.31 < S_{a,ICF} \leq 0.79$ and Hourly Wind Pressure, $q_{1/50} \leq 1.05kPa$ , for ICF Walls with 8” Tie Spacing .....  | 54 |
| Table A.1.1. Above Grade Wall Distributed Reinforcement for Seismic Zone Classification, $S_{a,ICF} \leq 0.16$ and Hourly Wind Pressure, $q_{1/50} \leq 1.05kPa$ , for ICF Walls with 6” Tie Spacing.....                     | 55 |
| Table A.1.2. Above Grade Wall Distributed Reinforcement for Seismic Zone Classification, $S_{a,ICF} \leq 0.16$ and Hourly Wind Pressure, $q_{1/50} \leq 1.05kPa$ , for ICF Walls with 8” Tie Spacing.....                     | 56 |
| Table A.2.1. Above Grade Wall Distributed Reinforcement for Seismic Zone Classification, $S_{a,ICF} > 0.16$ and Hourly Wind Pressure, $q_{1/50} \leq 1.05kPa$ for, ICF Walls with 6” Tie Spacing.....                         | 57 |

|  |    |
|--|----|
| Table A.2.2. Above Grade Wall Distributed Reinforcement for Seismic Zone Classification, $S_{a,ICF} > 0.16$ and Hourly Wind Pressure, $q_{1/50} \leq 1.05\text{kPa}$ for, ICF Walls with 8" Tie Spacing.....   | 58 |
| Table A.3.3200. Above Grade Shear Wall Length for Seismic Zone Classification, $S_{a,ICF} \leq 0.16$ and Hourly Wind Pressure, $q_{1/50} \leq 0.5\text{kPa}$ (in a Building Without Walkout Basement), where Building Area $\leq 3200\text{ft}^2$ .....                  | 59 |
| Table A.4.3200. Above Grade Shear Wall Length for Seismic Zone Classification, $S_{a,ICF} \leq 0.16$ and Hourly Wind Pressure, $0.5\text{kPa} < q_{1/50} \leq 0.75\text{kPa}$ (in a Building Without Walkout Basement), where Building Area $\leq 3200\text{ft}^2$ ..... | 60 |
| Table A.5.3200. Above Grade Shear Wall Length for Seismic Zone Classification, $S_{a,ICF} \leq 0.16$ and Hourly Wind Pressure, $0.5\text{kPa} < q_{1/50} \leq 0.75\text{kPa}$ (in a Building Without Walkout Basement), where Building Area $\leq 3200\text{ft}^2$ ..... | 61 |
| Table A.6.3200. Above Grade Shear Wall Length for Seismic Zone Classification, $S_{a,ICF} > 0.16$ and Hourly Wind Pressure, $q_{1/50} \leq 1.05\text{kPa}$ (in a Building Without Walkout Basement), where Building Area $\leq 3200\text{ft}^2$ .....                    | 62 |
| Table A.7.3200. Above Grade Shear Wall Length for Seismic Zone Classification, $S_{a,ICF} \leq 0.16$ and Hourly Wind Pressure, $q_{1/50} \leq 0.5\text{kPa}$ (in a Building With Walk Basement), where Building Area $\leq 3200\text{ft}^2$ .....                        | 63 |
| Table A.8.3200. Above Grade Shear Wall Length for Seismic Zone Classification, $S_{a,ICF} \leq 0.16$ and Hourly Wind Pressure, $0.5\text{kPa} < q_{1/50} \leq 0.75\text{kPa}$ (in a Building With Walkout Basement), where Building Area $\leq 3200\text{ft}^2$ .....    | 64 |
| Table A.9.3200. Above Grade Shear Wall Length for Seismic Zone Classification, $S_{a,ICF} \leq 0.16$ and Hourly Wind Pressure, $0.75\text{kPa} < q_{1/50} \leq 1.05\text{kPa}$ (in a Building With Walkout Basement), where Building Area $\leq 3200\text{ft}^2$ .....   | 65 |
| Table A.10.3200. Above Grade Shear Wall Length for Seismic Zone Classification, $S_{a,ICF} > 0.16$ and Hourly Wind Pressure, $q_{1/50} \leq 1.05\text{kPa}$ (in a Building With Walkout Basement), where Building Area $\leq 3200\text{ft}^2$ .....                      | 66 |
| Table A. 11.3200. – Above Grade Walkout Basement Shear Wall Length for Seismic Zone Classification, $S_{a,ICF} \leq 0.31$ and Hourly Wind Pressure, $q_{1/50} \leq 1.05\text{kPa}$ , where Building Area $\leq 3200\text{ft}^2$ .....                                    | 67 |
| Table A.3.2400. Above Grade Shear Wall Length for Seismic Zone Classification, $S_{a,ICF} \leq 0.16$ and Hourly Wind Pressure, $q_{1/50} \leq 0.5\text{kPa}$ (in a Building Without Walkout Basement), where Building Area $\leq 2400\text{ft}^2$ .....                  | 68 |
| Table A.4.2400. Above Grade Shear Wall Length for Seismic Zone Classification, $S_{a,ICF} \leq 0.16$ and Hourly Wind Pressure, $0.5\text{kPa} < q_{1/50} \leq 0.75\text{kPa}$ (in a Building Without Walkout Basement), where Building Area $\leq 2400\text{ft}^2$ ..... | 69 |
| Table A.5.2400. Above Grade Shear Wall Length for Seismic Zone Classification, $S_{a,ICF} \leq 0.16$ and Hourly Wind Pressure, $0.5\text{kPa} < q_{1/50} \leq 0.75\text{kPa}$ (in a Building Without Walkout Basement), where Building Area $\leq 2400\text{ft}^2$ ..... | 70 |
| Table A.6.2400. Above Grade Shear Wall Length for Seismic Zone Classification, $S_{a,ICF} > 0.16$ and Hourly Wind Pressure, $q_{1/50} \leq 1.05\text{kPa}$ (in a Building Without Walkout Basement), where Building Area $\leq 2400\text{ft}^2$ .....                    | 71 |
| Table A.7.2400. Above Grade Shear Wall Length for Seismic Zone Classification, $S_{a,ICF} \leq 0.16$ and Hourly Wind Pressure, $q_{1/50} \leq 0.5\text{kPa}$ (in a Building With Walk Basement), where Building Area $\leq 2400\text{ft}^2$ .....                        | 72 |
| Table A.8.2400. Above Grade Shear Wall Length for Seismic Zone Classification, $S_{a,ICF} \leq 0.16$ and Hourly Wind Pressure, $0.5\text{kPa} < q_{1/50} \leq 0.75\text{kPa}$ (in a Building With Walkout Basement), where Building Area $\leq 2400\text{ft}^2$ .....    | 73 |
| Table A.9.2400. Above Grade Shear Wall Length for Seismic Zone Classification, $S_{a,ICF} \leq 0.16$ and Hourly Wind Pressure, $0.75\text{kPa} < q_{1/50} \leq 1.05\text{kPa}$ (in a Building With Walkout Basement), where Building Area $\leq 2400\text{ft}^2$ .....   | 74 |

|  |    |
|--|----|
| Table A.10.2400. Above Grade Shear Wall Length for Seismic Zone Classification, $S_{a,ICF} > 0.16$ and Hourly Wind Pressure, $q1/50 \leq 1.05kPa$ (in a Building With Walkout Basement), where Building Area $\leq 2400ft^2$ .....               | 75 |
| Table A. 11.2400. – Above Grade Walkout Basement Shear Wall Length for Seismic Zone Classification, $S_{a,ICF} \leq 0.31$ and Hourly Wind Pressure, $q1/50 \leq 1.05kPa$ , where Building Area $\leq 2400ft^2$ .....                             | 76 |
| Table A.3.1600. Above Grade Shear Wall Length for Seismic Zone Classification, $S_{a,ICF} \leq 0.16$ and Hourly Wind Pressure, $q1/50 \leq 0.5kPa$ (in a Building Without Walkout Basement), where Building Area $\leq 1600ft^2$ .....           | 77 |
| Table A.4.1600. Above Grade Shear Wall Length for Seismic Zone Classification, $S_{a,ICF} \leq 0.16$ and Hourly Wind Pressure, $0.5kPa < q1/50 \leq 0.75kPa$ (in a Building Without Walkout Basement), where Building Area $\leq 1600ft^2$ ..... | 78 |
| Table A.5.1600. Above Grade Shear Wall Length for Seismic Zone Classification, $S_{a,ICF} \leq 0.16$ and Hourly Wind Pressure, $0.5kPa < q1/50 \leq 0.75kPa$ (in a Building Without Walkout Basement), where Building Area $\leq 1600ft^2$ ..... | 79 |
| Table A.6.1600. Above Grade Shear Wall Length for Seismic Zone Classification, $S_{a,ICF} > 0.16$ and Hourly Wind Pressure, $q1/50 \leq 1.05kPa$ (in a Building Without Walkout Basement), where Building Area $\leq 1600ft^2$ .....             | 80 |
| Table A.7.1600. Above Grade Shear Wall Length for Seismic Zone Classification, $S_{a,ICF} \leq 0.16$ and Hourly Wind Pressure, $q1/50 \leq 0.5kPa$ (in a Building With Walk Basement), where Building Area $\leq 1600ft^2$ .....                 | 81 |
| Table A.8.1600. Above Grade Shear Wall Length for Seismic Zone Classification, $S_{a,ICF} \leq 0.16$ and Hourly Wind Pressure, $0.5kPa < q1/50 \leq 0.75kPa$ (in a Building With Walkout Basement), where Building Area $\leq 1600ft^2$ .....    | 82 |
| Table A.9.1600. Above Grade Shear Wall Length for Seismic Zone Classification, $S_{a,ICF} \leq 0.16$ and Hourly Wind Pressure, $0.75kPa < q1/50 \leq 1.05kPa$ (in a Building With Walkout Basement), where Building Area $\leq 1600ft^2$ .....   | 83 |
| Table A.10.1600. Above Grade Shear Wall Length for Seismic Zone Classification, $S_{a,ICF} > 0.16$ and Hourly Wind Pressure, $q1/50 \leq 1.05kPa$ (in a Building With Walkout Basement), where Building Area $\leq 1600ft^2$ .....               | 84 |
| Table A. 11.1600. – Above Grade Walkout Basement Shear Wall Length for Seismic Zone Classification, $S_{a,ICF} \leq 0.31$ and Hourly Wind Pressure, $q1/50 \leq 1.05kPa$ , where Building Area $\leq 1600ft^2$ .....                             | 85 |
| Table A.3.800. Above Grade Shear Wall Length for Seismic Zone Classification, $S_{a,ICF} \leq 0.16$ and Hourly Wind Pressure, $q1/50 \leq 0.5kPa$ (in a Building Without Walkout Basement), where Building Area $\leq 800ft^2$ .....             | 86 |
| Table A.4.800. Above Grade Shear Wall Length for Seismic Zone Classification, $S_{a,ICF} \leq 0.16$ and Hourly Wind Pressure, $0.5kPa < q1/50 \leq 0.75kPa$ (in a Building Without Walkout Basement), where Building Area $\leq 800ft^2$ .....   | 87 |
| Table A.5.800. Above Grade Shear Wall Length for Seismic Zone Classification, $S_{a,ICF} \leq 0.16$ and Hourly Wind Pressure, $0.5kPa < q1/50 \leq 0.75kPa$ (in a Building Without Walkout Basement), where Building Area $\leq 800ft^2$ .....   | 88 |
| Table A.6.800. Above Grade Shear Wall Length for Seismic Zone Classification, $S_{a,ICF} > 0.16$ and Hourly Wind Pressure, $q1/50 \leq 1.05kPa$ (in a Building Without Walkout Basement), where Building Area $\leq 800ft^2$ .....               | 89 |
| Table A.7.800. Above Grade Shear Wall Length for Seismic Zone Classification, $S_{a,ICF} \leq 0.16$ and Hourly Wind Pressure, $q1/50 \leq 0.5kPa$ (in a Building With Walk Basement), where Building Area $\leq 800ft^2$ .....                   | 90 |

|   |     |
|---|-----|
| Table A.8.800. Above Grade Shear Wall Length for Seismic Zone Classification, $S_{a,ICF} \leq 0.16$ and Hourly Wind Pressure, $0.5kPa < q_{1/50} \leq 0.75kPa$ (in a Building With Walkout Basement), where Building Area $\leq 800ft^2$ .....  | 91  |
| Table A.9.800. Above Grade Shear Wall Length for Seismic Zone Classification, $S_{a,ICF} \leq 0.16$ and Hourly Wind Pressure, $0.75kPa < q_{1/50} \leq 1.05kPa$ (in a Building With Walkout Basement), where Building Area $\leq 800ft^2$ ..... | 92  |
| Table A.10.800. Above Grade Shear Wall Length for Seismic Zone Classification, $S_{a,ICF} > 0.16$ and Hourly Wind Pressure, $q_{1/50} \leq 1.05kPa$ (in a Building With Walkout Basement), where Building Area $\leq 800ft^2$ .....             | 93  |
| Table A. 11.800. – Above Grade Walkout Basement Shear Wall Length for Seismic Zone Classification, $S_{a,ICF} \leq 0.31$ and Hourly Wind Pressure, $q_{1/50} \leq 1.05kPa$ , where Building Area $\leq 800ft^2$ ....                            | 94  |
| Table L. 1. 6” Lintel Reinforcement with Uniformly Distributed Load .....   | 98  |
| Table L. 2. 8” Lintel Reinforcement with Uniformly Distributed Load .....   | 101 |
| Table L. 3. 10” Lintel Reinforcement with Uniformly Distributed Load .....  | 104 |
| Table L. 4. 12” Lintel Reinforcement with Uniformly Distributed Load .....  | 107 |
| Table L. 5. 6” Lintel Reinforcement with Concentrated Load .....  | 110 |
| Table L. 6. 8” Lintel Reinforcement with Concentrated Load .....  | 113 |
| Table L. 7. 10” Lintel Reinforcement with Concentrated Load .....   | 116 |
| Table L. 8. 12” Lintel Reinforcement with Concentrated Load .....   | 119 |
| Table C. 1. Maximum Un-Factored Point Load on a Solid Wall Without Opening .....  | 122 |
| Table A. 12. Above Grade Wall Distributed Horizontal Reinforcement at Stair Openings .....  | 123 |
| Table B. 5. Below Grade Wall Distributed Horizontal Reinforcement at Stair Opening for Seismic Zone Classification $S_a(0.2) \leq 0.7$ , Hourly Wind Pressure , $q_{1/50} \leq 1.05 kPa$ , and Backfill .....                                   | 124 |
| Table A. 13. Bar Spacing Required at Each Side of the Stair Opening .....   | 125 |
| Table B. 6. Maximum Height of Finish Ground Above Basement Floor .....  | 126 |
| Table C. 2. Floor Ledger Anchor Bolts Size and Spacing .....  | 129 |
| Table C. 3. Brick Ledge Load Capacity .....   | 131 |
| Table F. 1. Footing Dowels Size and Spacing .....   | 132 |
| Table F. 2. Minimum Exterior Strip Footing Sizes Not Supporting Roof Loads .....  | 133 |
| Table F. 3. Minimum Exterior Strip Footing Sizes Supporting Roof Snow Loads $\leq 2kPa$ .....   | 134 |
| Table F. 4. Minimum Exterior Strip Footing Sizes Supporting Roof Snow Loads $\leq 4kPa$ .....   | 135 |

## Below & Above Grade Walls Details and Tables

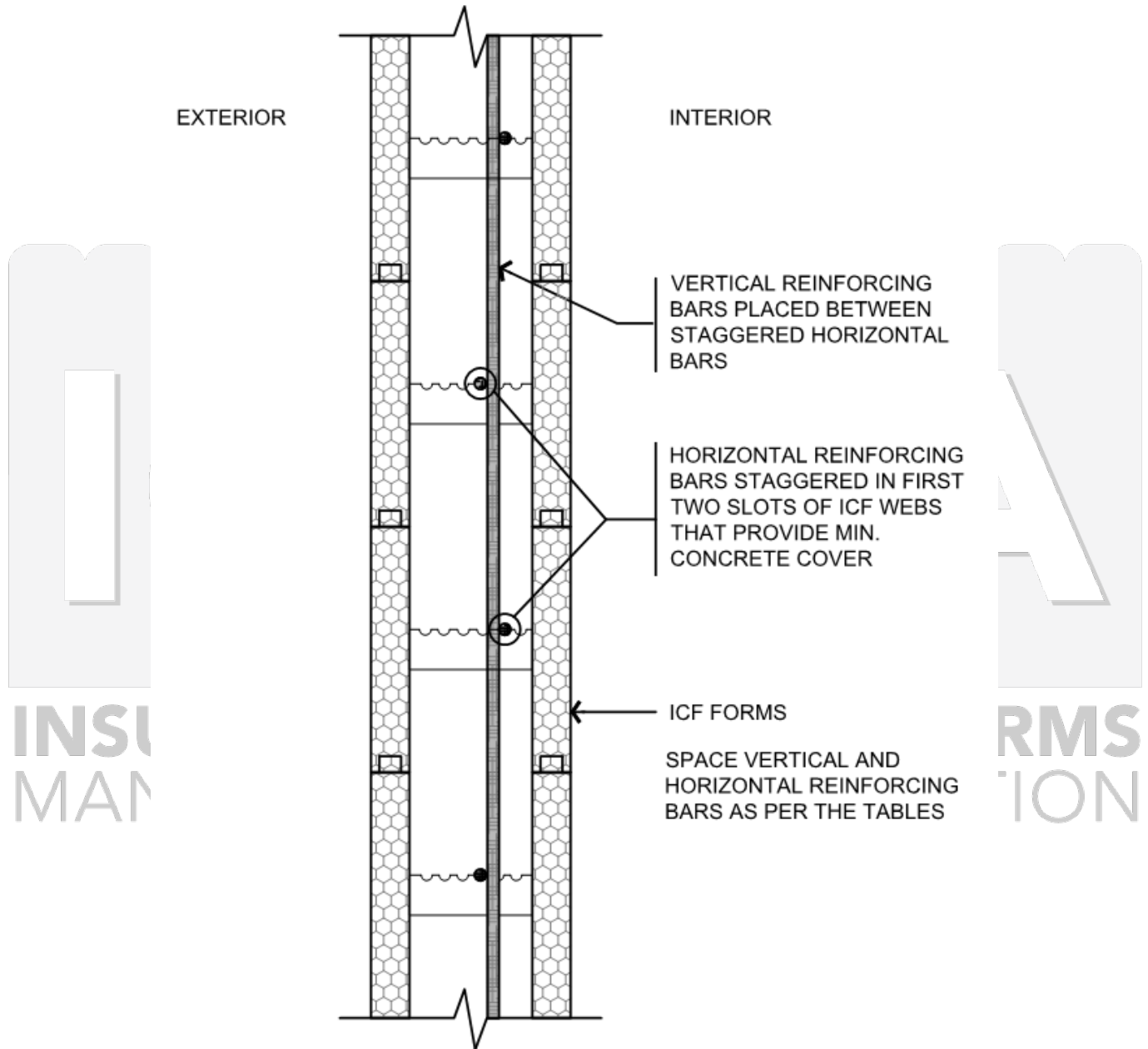

**Detail B. 1. Below Grade Wall Reinforcing Placement for All Wall Thicknesses.**

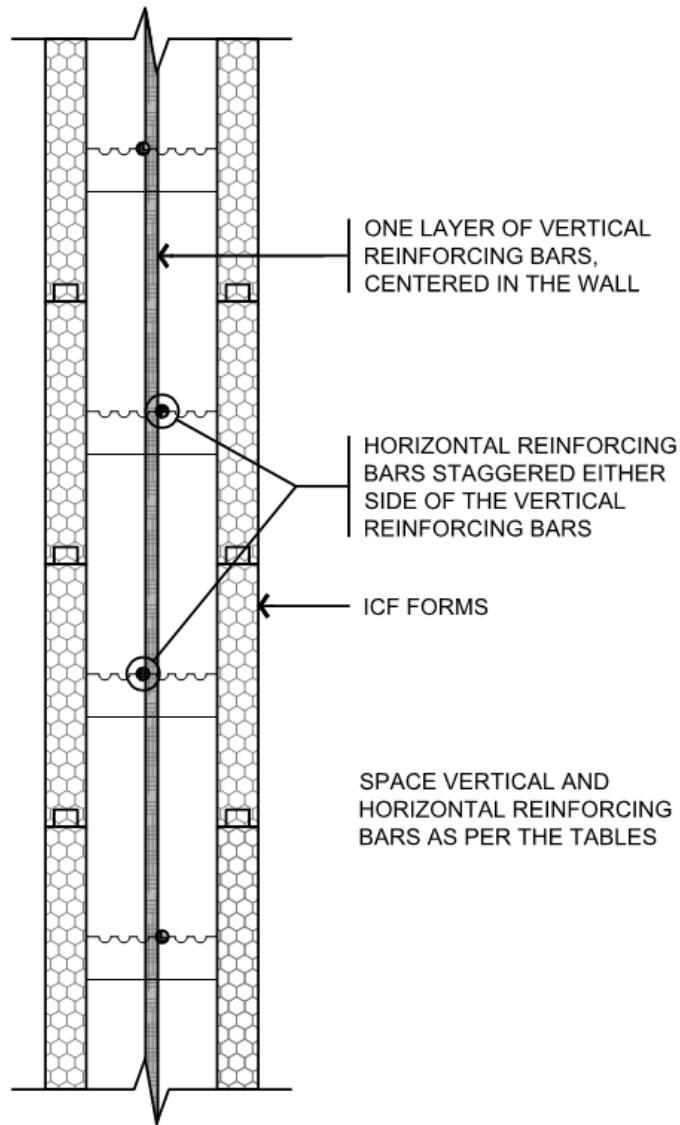

Detail A. 1. Above Grade Wall Reinforcing Placement for 6", 8" And 10" Thick Walls.

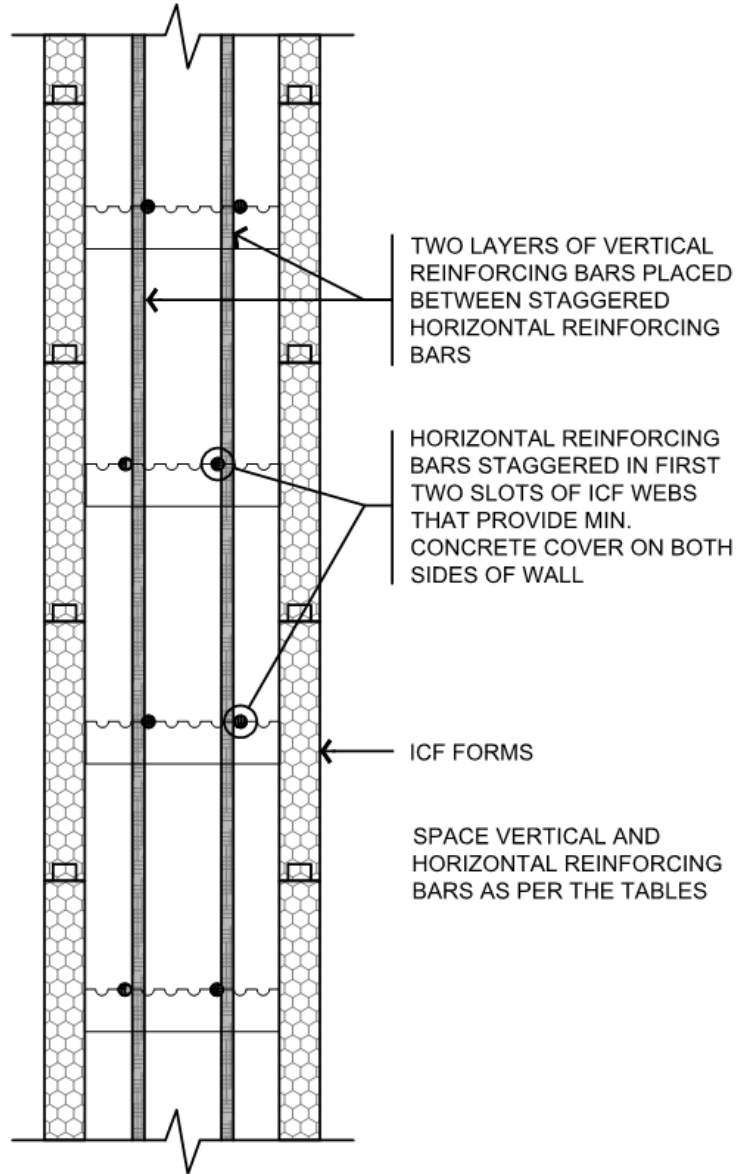

**Detail A. 2. Above Grade Wall Reinforcing Placement for 12" Thick Walls.**

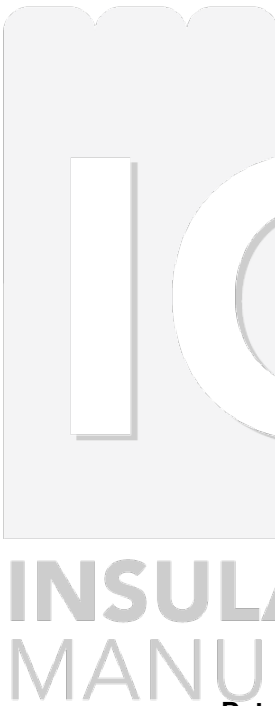

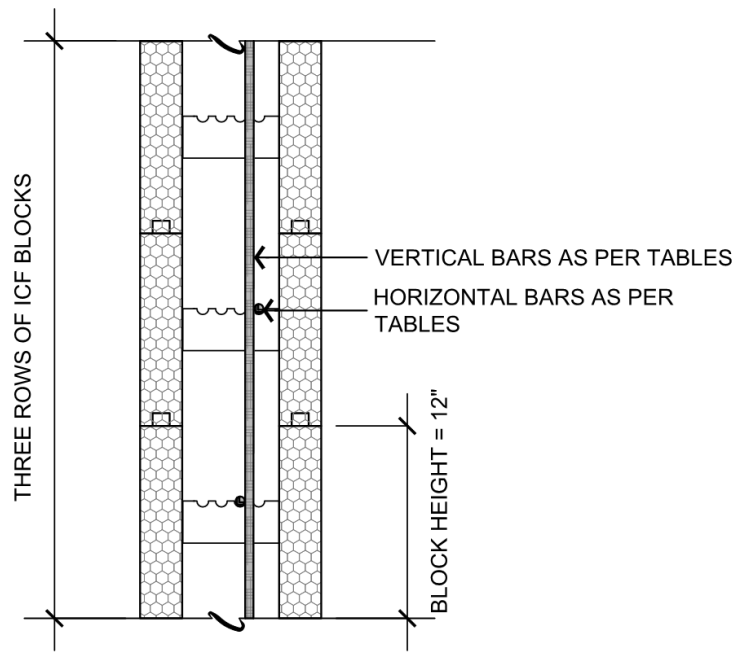

**Detail A. 3. Alternating Horizontal Bar Spacing of 12" O.C. and 24" O.C. to Achieve an Average Spacing of 18" O.C. (Two Horizontal Bars in Every Three Rows of ICF Blocks)**

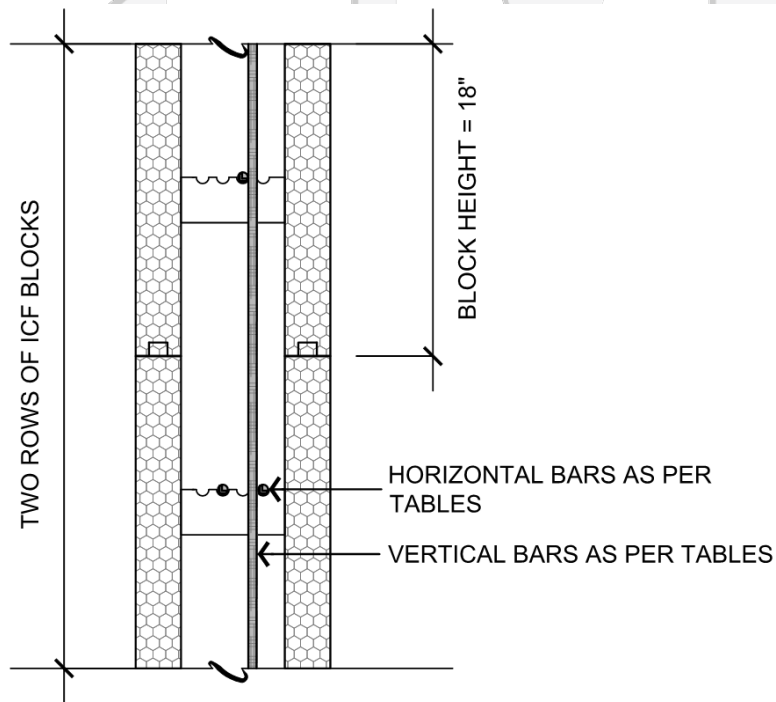

**Detail A. 4. Three Horizontal Bars in Every Two Rows of 18" High Block to Achieve an Average Spacing of 12" O.C.**

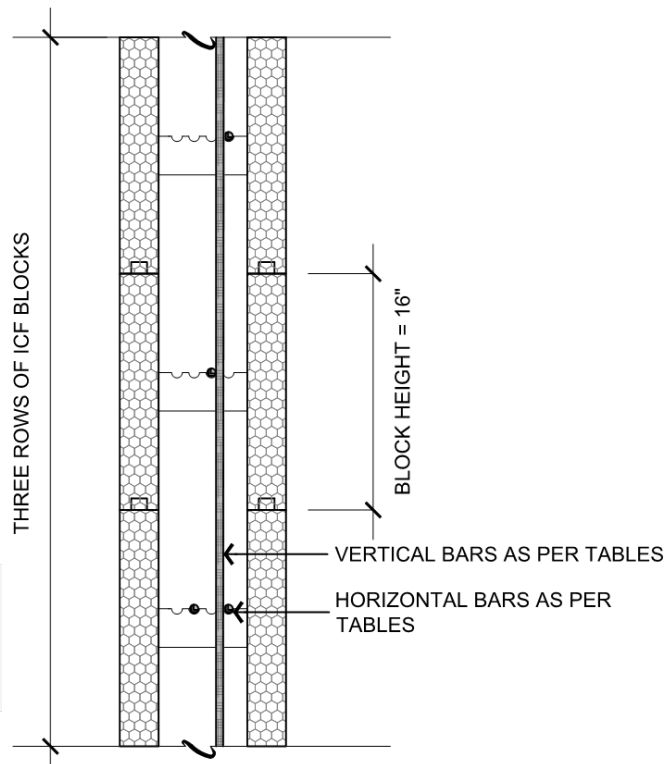

**Detail A. 5. Four Horizontal Bars in Every Three Rows of 16" High Block to Achieve an Average Spacing of 12" O.C.**

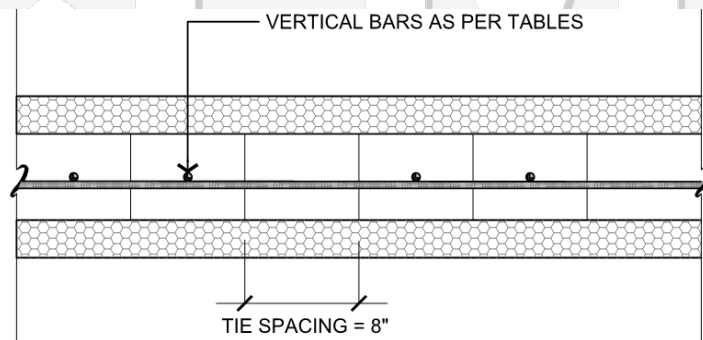

**Detail A. 6. Alternating Vertical Bar Spacing of 8" O.C. and 16" O.C. to Achieve an Average Spacing of 12" O.C. (Two Vertical Bars in Every Three Cells)**

**Detail A. 7. Wall Configurations in a Building Without Walkout Basement**

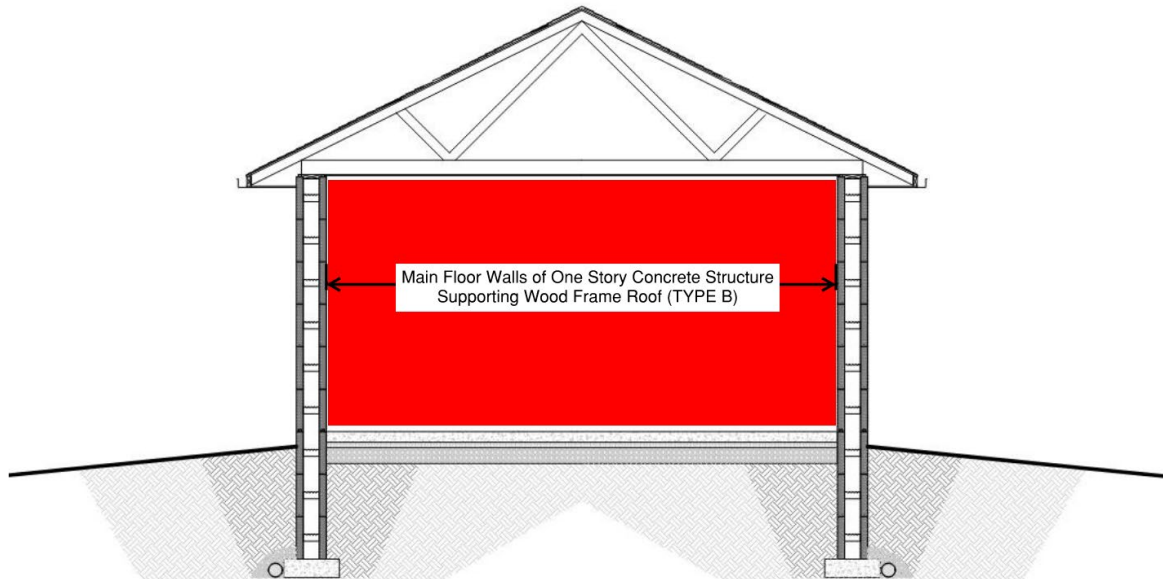

**Detail A. 7. 1. Main Floor Walls of One Story ICF Structure Supporting Wood Frame Roof (TYPE B).**

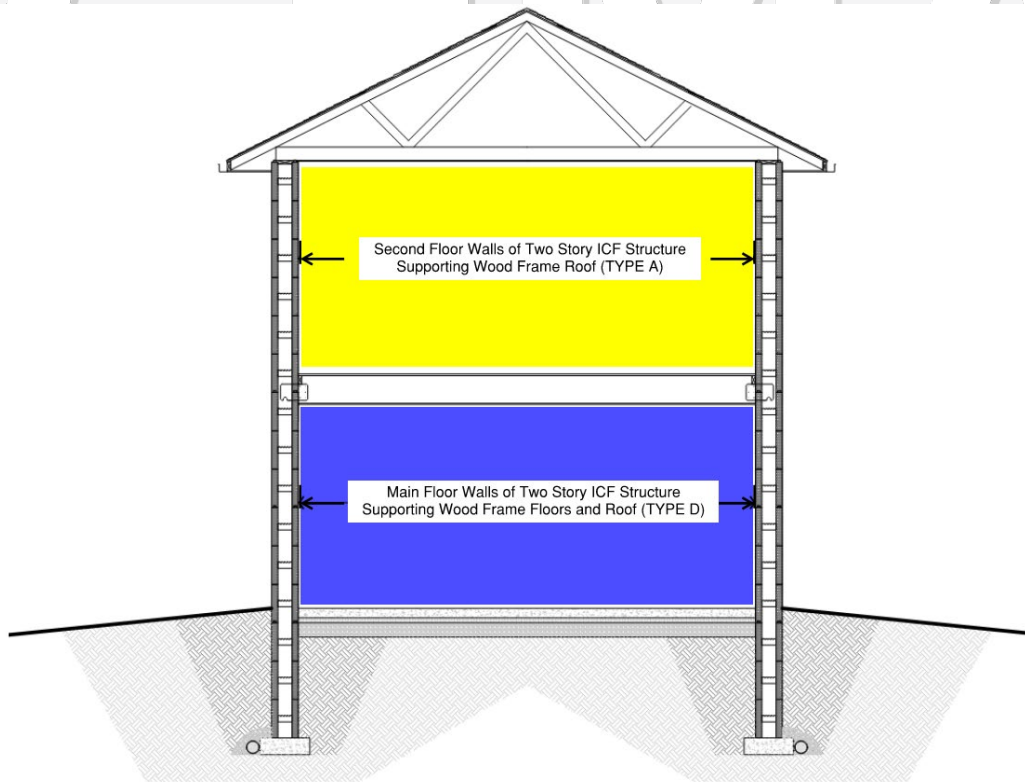

**Detail A. 7. 2. Second Floor Walls of a Two-Story ICF Structure Supporting Wood Frame Roof & Main Floor Walls of a Two-Story ICF Structure Supporting Wood Frame Floors and Roof (TYPE A & D).**

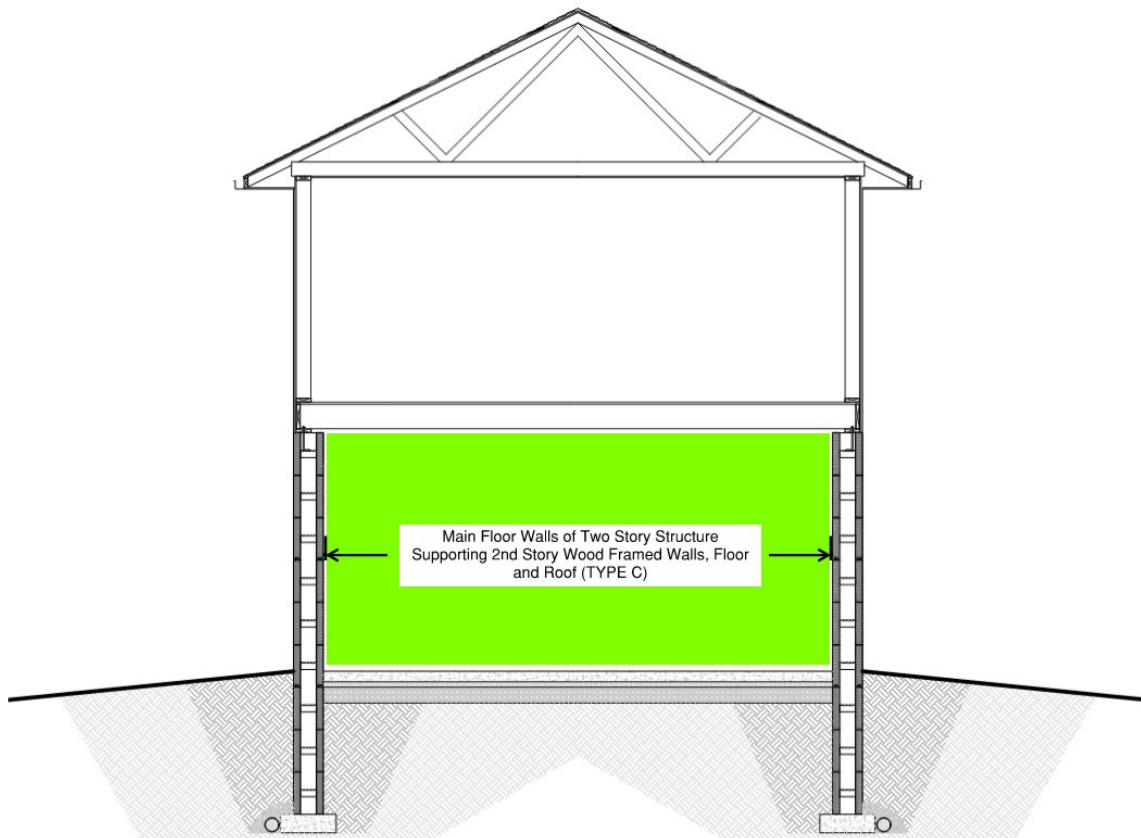

Detail A. 7. 3. Main Floor Walls of a Two-Story Structure Supporting 2<sup>nd</sup> Story Wood Frame Walls, Floor and Roof (TYPE C).

# INSULATING CONCRETE FORMS MANUFACTURERS ASSOCIATION

**Detail A. 8. Wall Configurations in a Building with Walkout Basement**

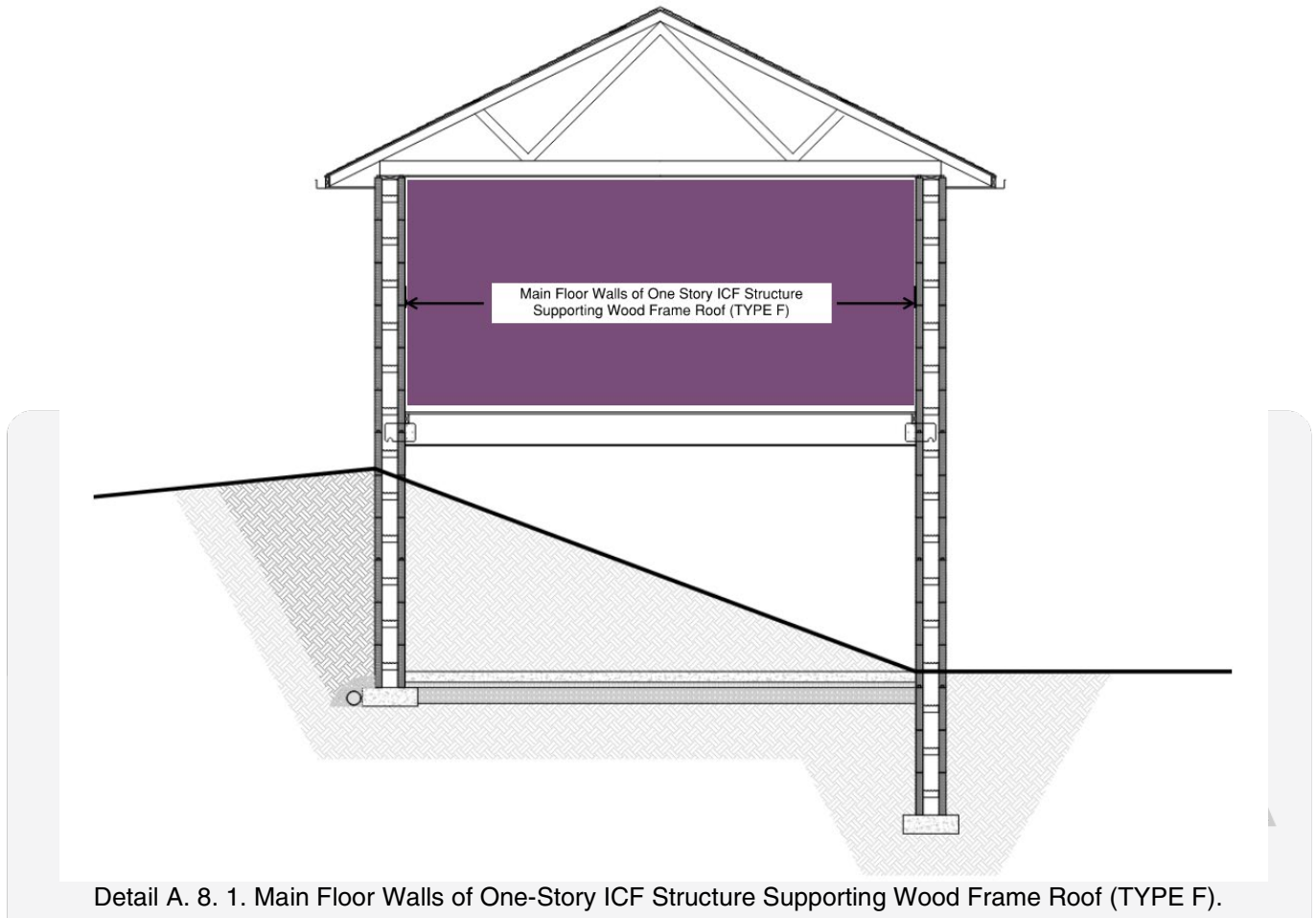

Detail A. 8. 1. Main Floor Walls of One-Story ICF Structure Supporting Wood Frame Roof (TYPE F).

**INSULATING CONCRETE FORMS**  
MANUFACTURERS ASSOCIATION

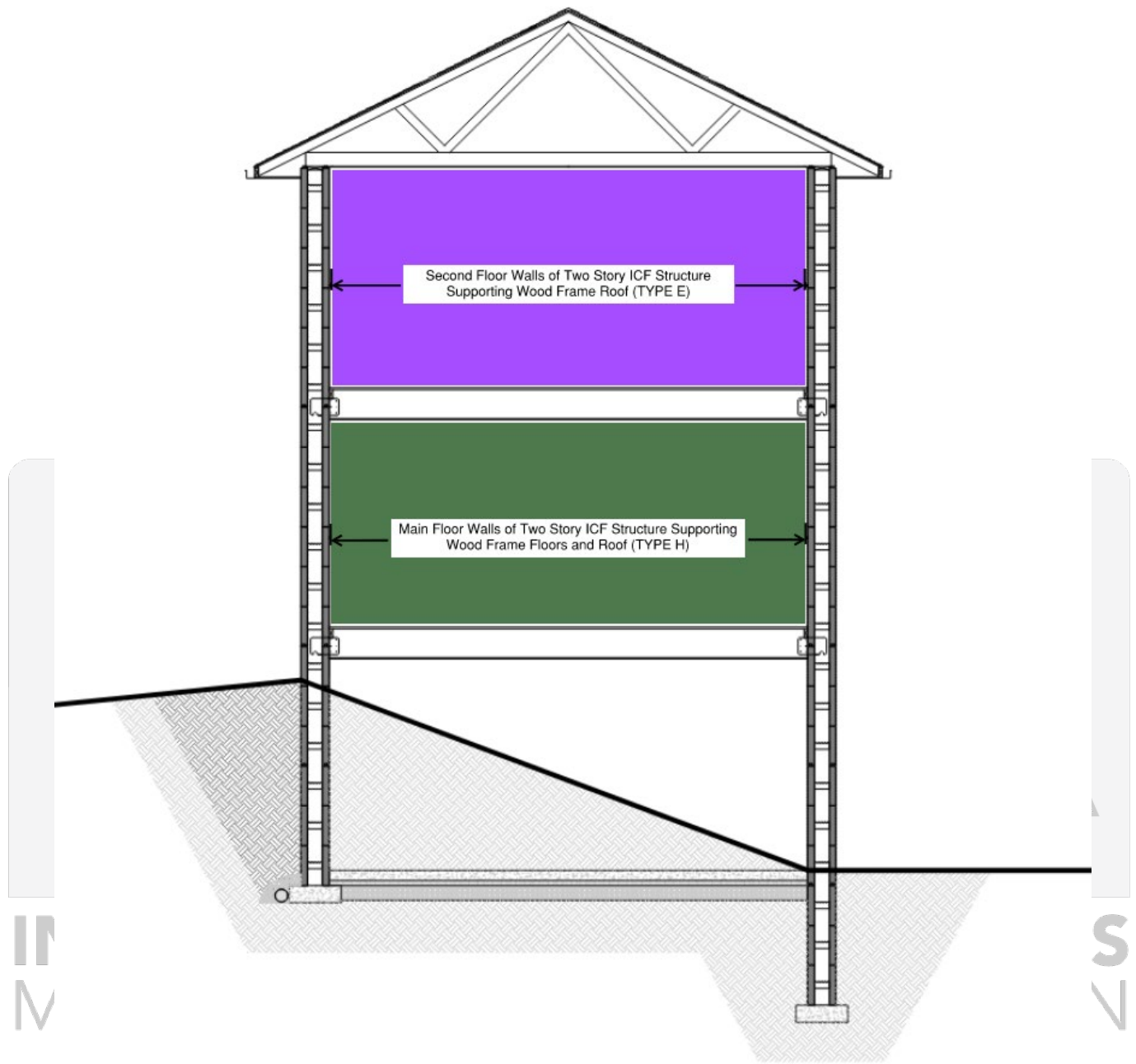

Detail A. 8. 2. Second Floor Walls of a Two-Story ICF Structure Supporting Wood Frame Roof & Main Floor Walls of a Two-Story ICF Structure Supporting Wood Frame Floors and Roof (TYPE E & H).

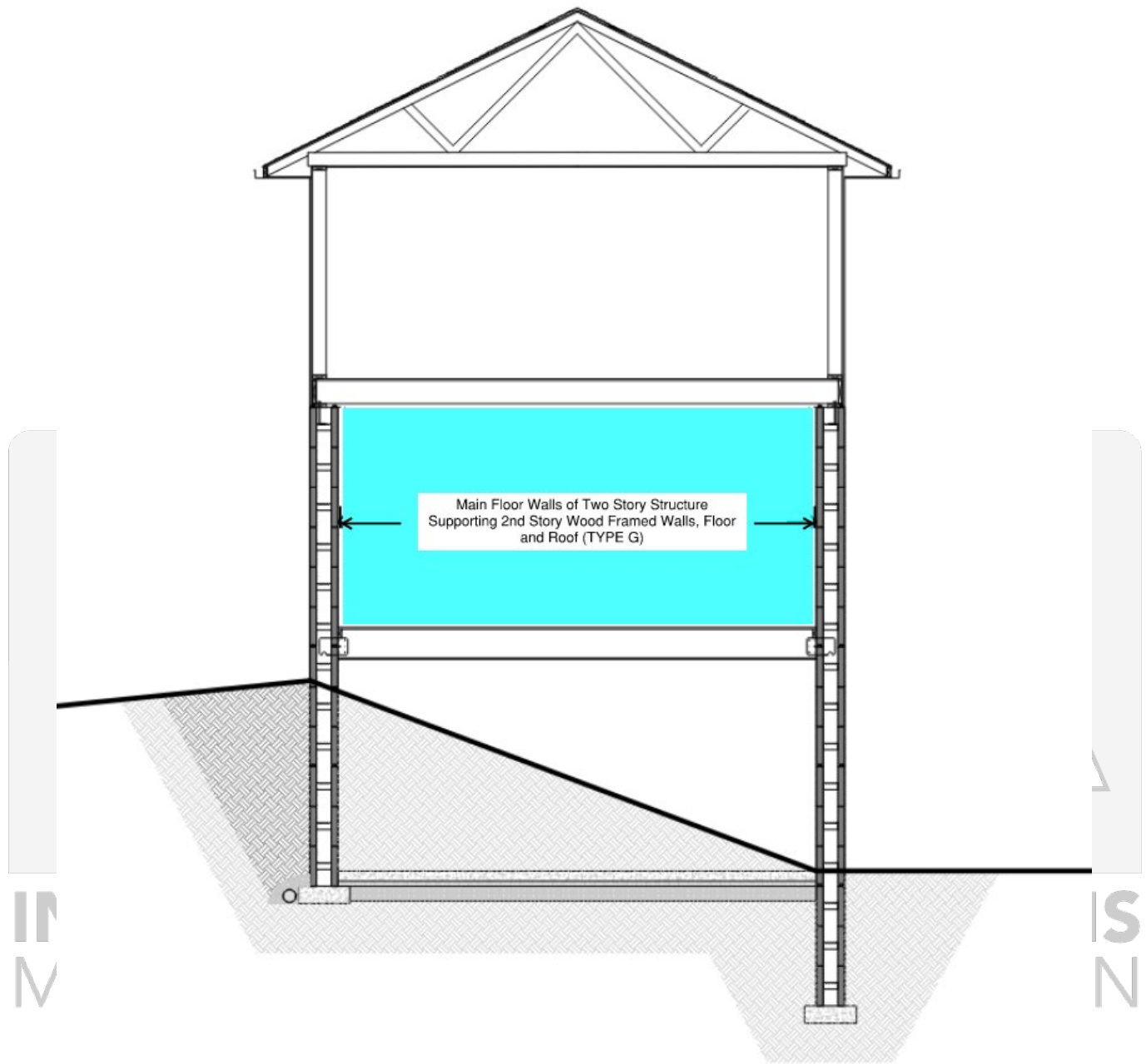

Detail A. 8. 3. Main Floor Walls of a Two-Story Structure Supporting 2<sup>nd</sup> Story Wood Frame Walls, Floor and Roof (TYPE G).

## Detail A. 9. Walkout Basement Wall Configurations

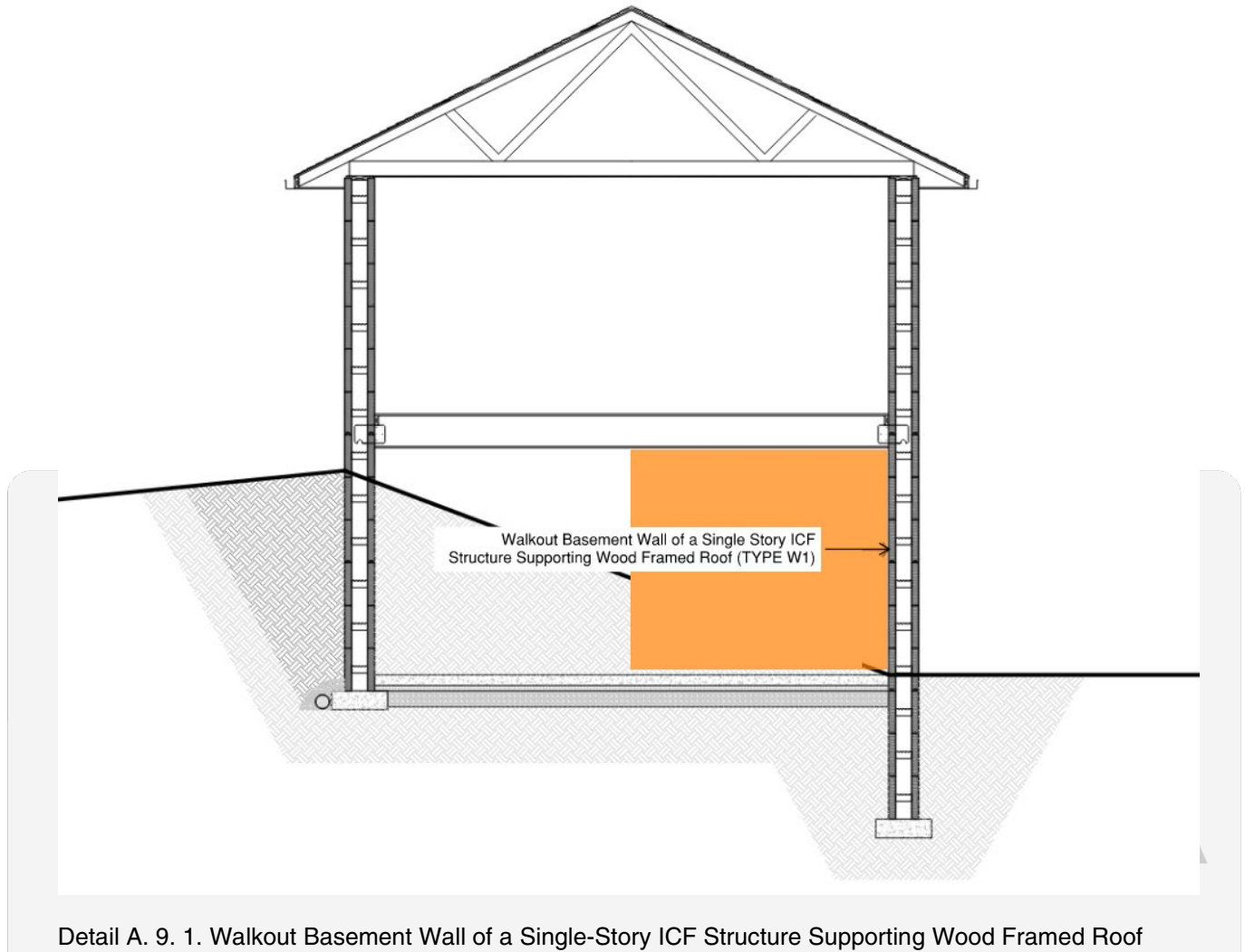

Detail A. 9. 1. Walkout Basement Wall of a Single-Story ICF Structure Supporting Wood Framed Roof (TYPE W1).

INSULATING CONCRETE FORMS  
MANUFACTURERS ASSOCIATION

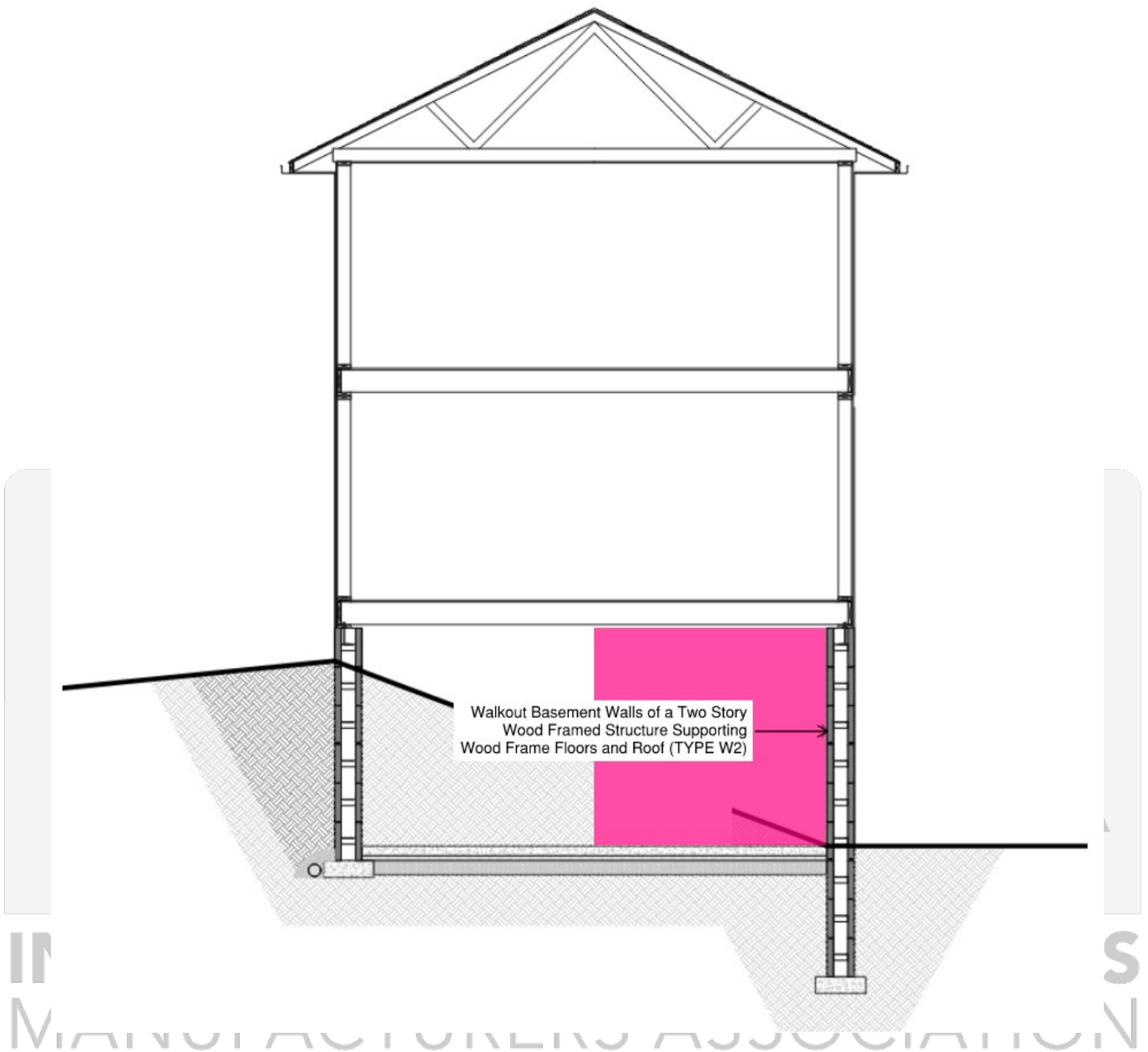

Detail A. 9. 2. Walkout Basement Wall of a Two-Story Wood Framed Structure Supporting Wood Frame Floors and Roof (TYPE W2).

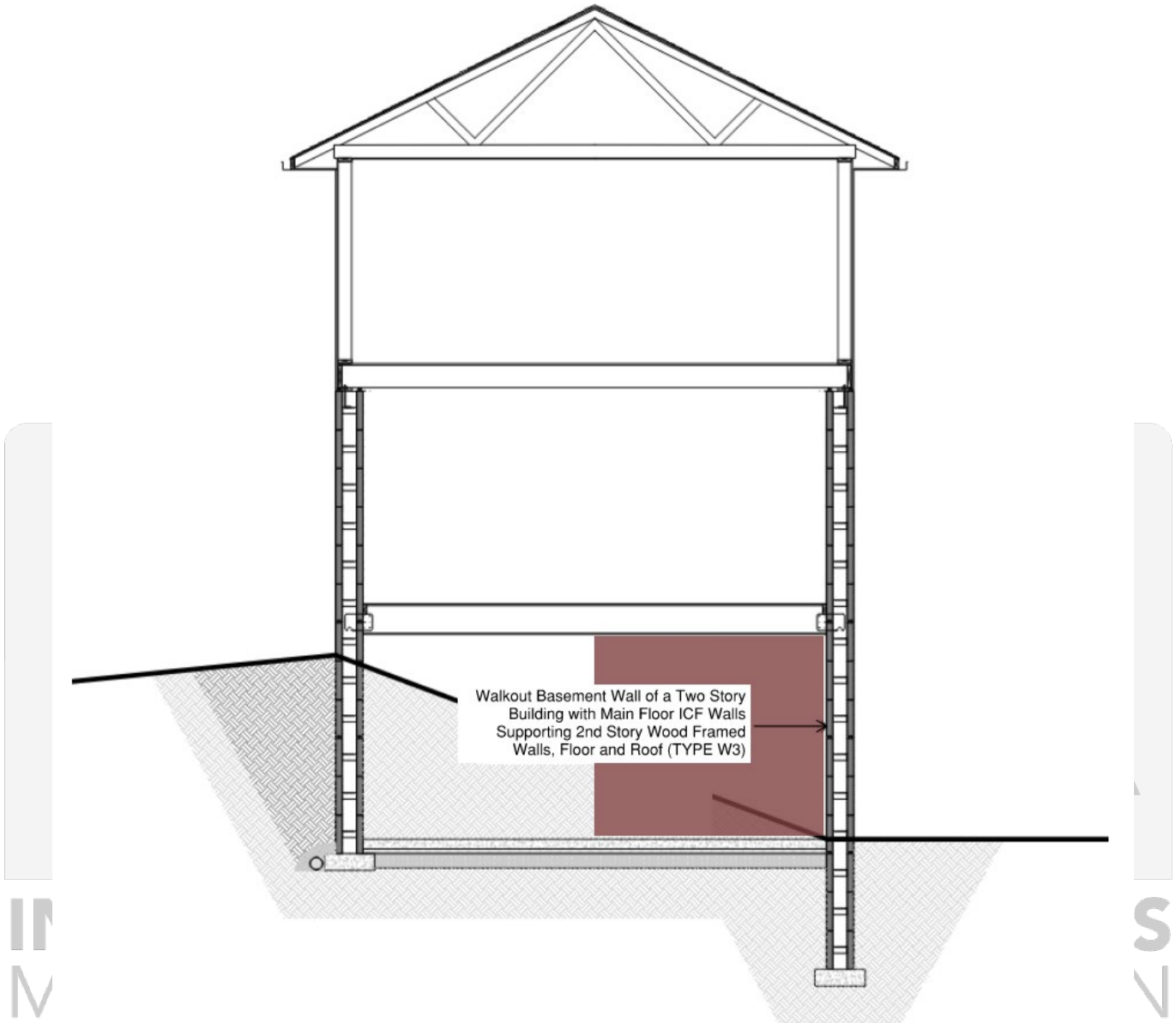

Detail A. 9. 3. Walkout Basement Wall of a Two-Story Building with Main Floor ICF Walls Supporting Second Story Wood Framed Walls, Floor and Roof (TYPE W3).

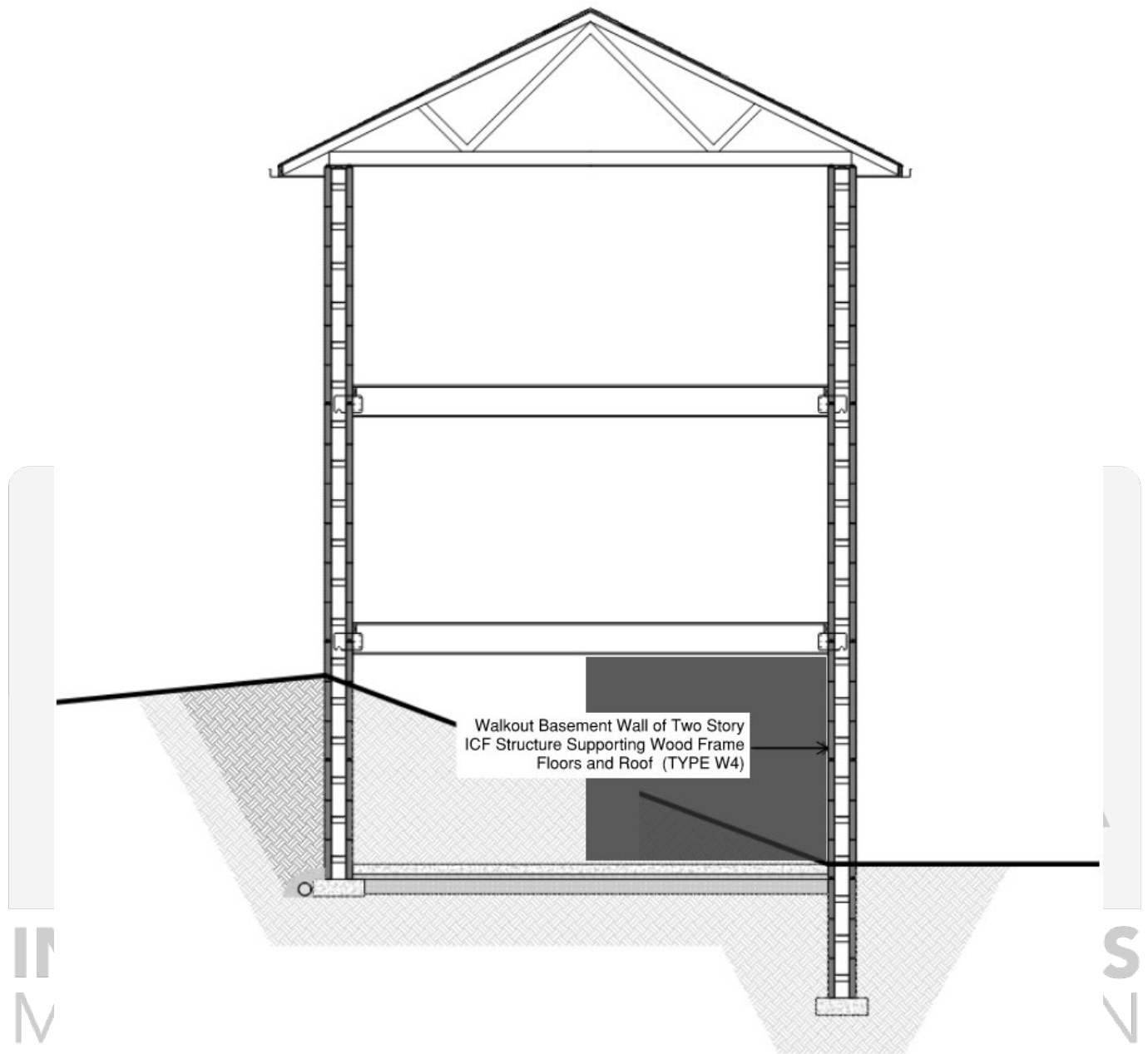

Detail A. 9. 4. Walkout Basement Wall of a Two-Story ICF Structure Supporting Wood Frame Floors, and Roof (TYPE W4).

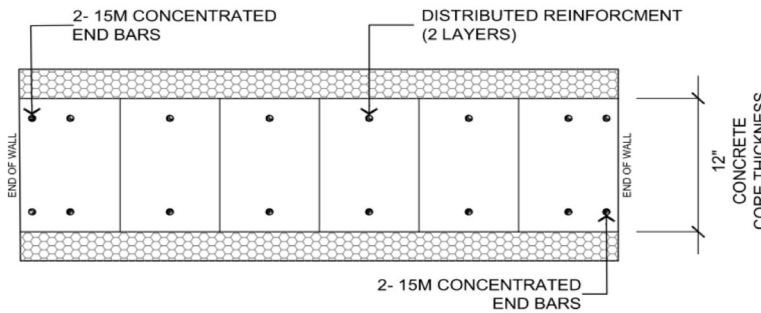
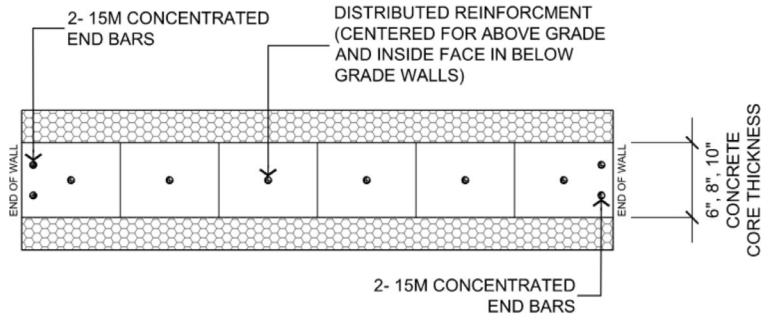

**REBAR PLACEMENT NOTES:**

1. PROVIDE 1-1/2" (40mm) COVER TO REINFORCING BARS, TYPICAL.
2. PROVIDE 1-1/2" (40mm) CLEAR SPACING BETWEEN BARS, TYPICAL.
3. PLACE CONCENTRATED BARS AS CLOSE TO THE SIDES OF THE WALL AS MINIMUM COVER PERMITS.

**Detail A. 10. Shear Wall Distributed and Concentrated Vertical Reinforcing Placement.**

# INSULATING CONCRETE FORMS MANUFACTURERS ASSOCIATION

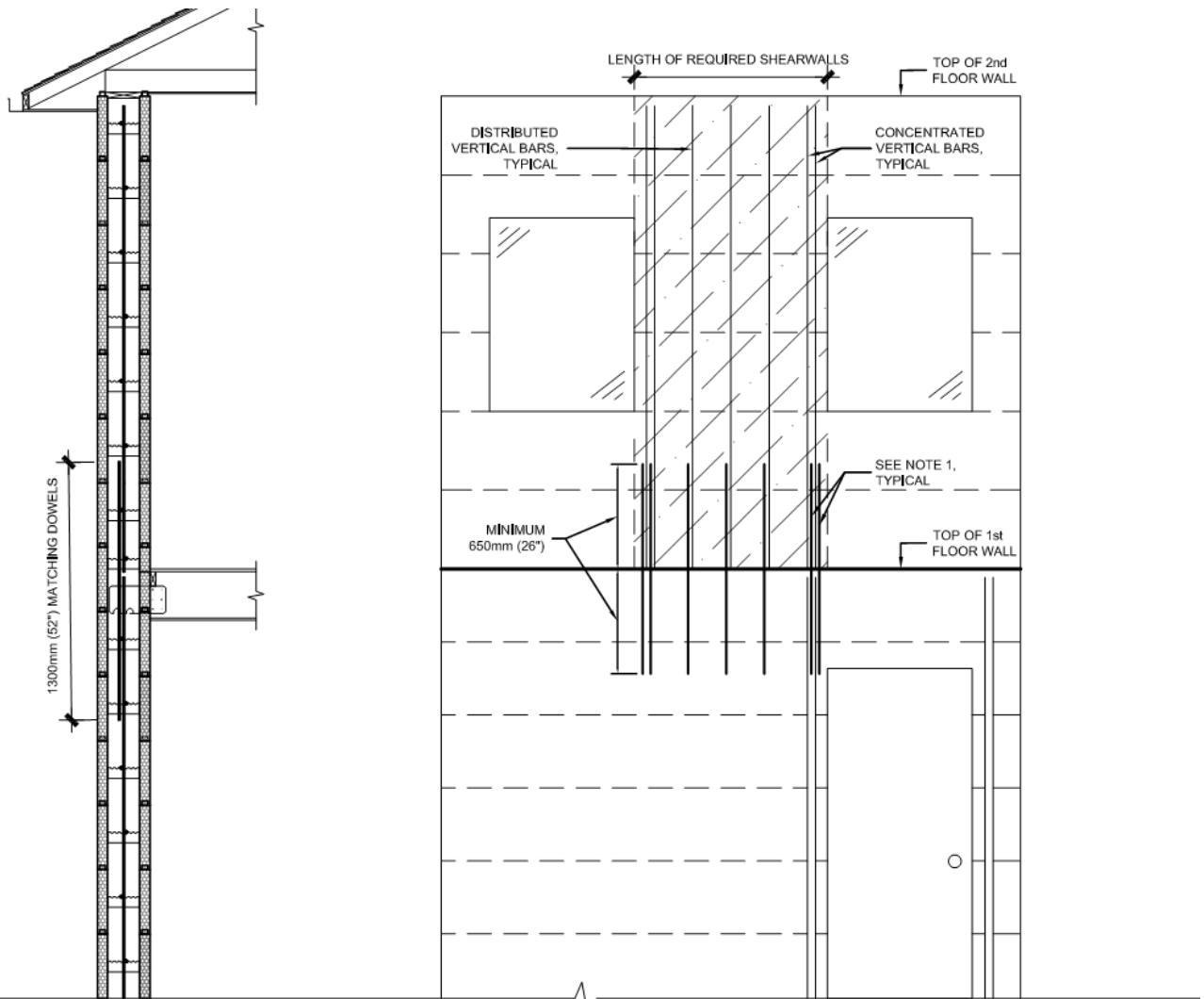

NOTES

1. PROVIDE 1300mm (52") LONG MATCHING DOWELS INTO WALL BELOW WALL. DOWELS INSTALLED PRIOR TO CONSTRUCTING FLOOR ABOVE

INSULATING CONCRETE FORMS  
**Detail A. 11. Shear Wall Dowels.**  
 MANUFACTURERS ASSOCIATION

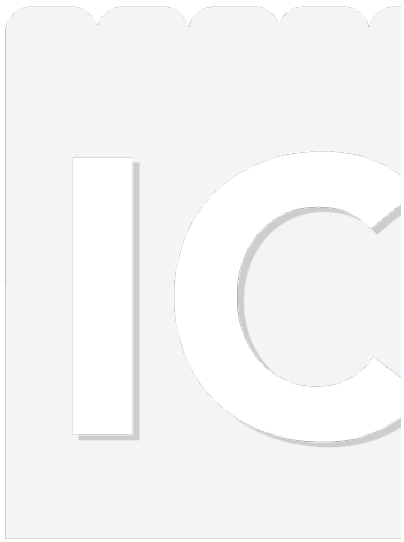

INSULATING  
CONCRETE FORMS  
MANUFACTURERS ASSOCIATION

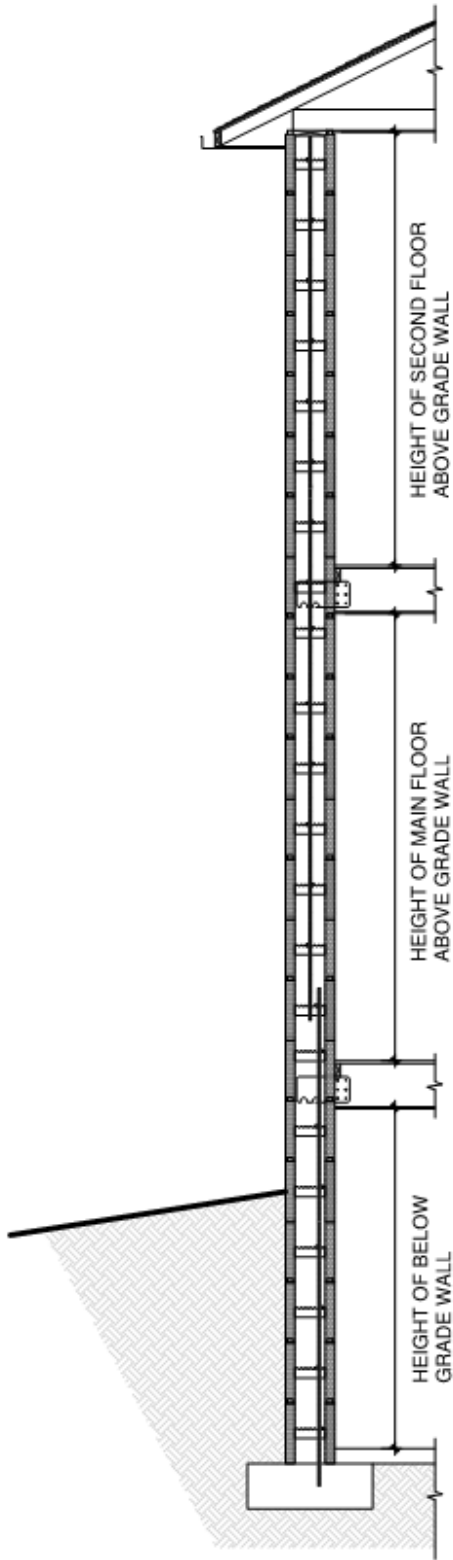

THE FORMS  
ASSOCIATION

**Detail A. 12. Above and Below Grade Wall Height.**

**Table B.1.1.– Below Grade Wall Distributed Reinforcement for Seismic Zone Classification,  $S_{a,ICF} \leq 0.11$  and Hourly Wind Pressure,  $q_{1/50} \leq 1.05kPa$ , for ICF Walls with 6" Tie Spacing**

| Wall Height<br>m<br>(ft) | Backfill Height<br>m<br>(ft) | Vertical Steel (Size and Spacing) |                     |                      |                      |                                |                     |                      |                      |
|--------------------------|------------------------------|-----------------------------------|---------------------|----------------------|----------------------|--------------------------------|---------------------|----------------------|----------------------|
|                          |                              | Backfill Equivalent Fluid Density |                     |                      |                      |                                |                     |                      |                      |
|                          |                              | 480 kg/m <sup>3</sup> (30 pcf)    |                     |                      |                      | 720 kg/m <sup>3</sup> (45 pcf) |                     |                      |                      |
|                          |                              | 150 mm (6")<br>25MPa Wall         | 200 mm (8")<br>Wall | 250 mm (10")<br>Wall | 300 mm (12")<br>Wall | 150 mm (6")<br>25MPa Wall      | 200 mm (8")<br>Wall | 250 mm (10")<br>Wall | 300 mm (12")<br>Wall |
| 2.44<br>(8.0)            | 1.22 (4.0)                   | 10 M @ 450 (18)                   | 10 M @ 750 (30)     | 10 M @ 900 (36)      | 10 M @ 900 (36)      | 10 M @ 30 (1)                  | 10 M @ 600 (24)     | 10 M @ 900 (36)      | 10 M @ 900 (36)      |
|                          | 1.53 (5.0)                   | 15 M @ 600 (24)                   | 10 M @ 600 (24)     | 10 M @ 750 (30)      | 10 M @ 900 (36)      | 15 M @ 600 (24)                | 10 M @ 450 (18)     | 10 M @ 750 (30)      | 10 M @ 900 (36)      |
|                          | 1.83 (6.0)                   | 15 M @ 600 (24)                   | 10 M @ 450 (18)     | 10 M @ 750 (30)      | 10 M @ 900 (36)      | 15 M @ 450 (18)                | 15 M @ 750 (30)     | 10 M @ 600 (24)      | 10 M @ 750 (30)      |
|                          | 2.13 (7.0)                   | 15 M @ 450 (18)                   | 15 M @ 750 (30)     | 10 M @ 600 (24)      | 10 M @ 600 (24)      | 15 M @ 450 (18)                | 15 M @ 600 (24)     | 10 M @ 450 (18)      | 10 M @ 600 (24)      |
|                          | 2.44 (8.0)                   | 15 M @ 450 (18)                   | 15 M @ 600 (24)     | 10 M @ 450 (18)      | 10 M @ 450 (18)      | 15 M @ 300 (12)                | 15 M @ 450 (18)     | 15 M @ 600 (24)      | 15 M @ 900 (36)      |
| 2.74<br>(9.0)            | 1.22 (4.0)                   | 15 M @ 750 (30)                   | 10 M @ 600 (24)     | 10 M @ 900 (36)      | 10 M @ 900 (36)      | 15 M @ 750 (30)                | 10 M @ 600 (24)     | 10 M @ 750 (30)      | 10 M @ 900 (36)      |
|                          | 1.53 (5.0)                   | 15 M @ 750 (30)                   | 10 M @ 450 (18)     | 10 M @ 750 (30)      | 10 M @ 900 (36)      | 15 M @ 600 (24)                | 10 M @ 450 (18)     | 10 M @ 600 (24)      | 10 M @ 900 (36)      |
|                          | 1.83 (6.0)                   | 15 M @ 600 (24)                   | 15 M @ 900 (36)     | 10 M @ 600 (24)      | 10 M @ 750 (30)      | 15 M @ 450 (18)                | 15 M @ 750 (30)     | 10 M @ 450 (18)      | 10 M @ 600 (24)      |
|                          | 2.13 (7.0)                   | 15 M @ 450 (18)                   | 15 M @ 750 (30)     | 10 M @ 450 (18)      | 10 M @ 600 (24)      | 15 M @ 450 (18)                | 15 M @ 450 (18)     | 15 M @ 750 (30)      | 15 M @ 900 (36)      |
|                          | 2.44 (8.0)                   | 15 M @ 300 (12)                   | 15 M @ 600 (24)     | 15 M @ 750 (30)      | 15 M @ 900 (36)      | 15 M @ 300 (12)                | 15 M @ 450 (18)     | 15 M @ 600 (24)      | 15 M @ 600 (24)      |
|                          | 2.74 (9.0)                   | 15 M @ 300 (12)                   | 15 M @ 450 (18)     | 15 M @ 600 (24)      | 15 M @ 750 (30)      | 15 M @ 150 (6)                 | 15 M @ 450 (18)     | 15 M @ 450 (18)      | 15 M @ 450 (18)      |
| 3.05<br>(10.0)           | 1.22 (4.0)                   | 15 M @ 750 (30)                   | 10 M @ 600 (24)     | 10 M @ 900 (36)      | 10 M @ 900 (36)      | 15 M @ 750 (30)                | 10 M @ 450 (18)     | 10 M @ 750 (30)      | 10 M @ 900 (36)      |
|                          | 1.53 (5.0)                   | 15 M @ 600 (24)                   | 15 M @ 900 (36)     | 10 M @ 600 (24)      | 10 M @ 900 (36)      | 15 M @ 600 (24)                | 15 M @ 750 (30)     | 10 M @ 600 (24)      | 10 M @ 750 (30)      |
|                          | 1.83 (6.0)                   | 15 M @ 450 (18)                   | 15 M @ 750 (30)     | 10 M @ 600 (24)      | 10 M @ 750 (30)      | 15 M @ 450 (18)                | 15 M @ 600 (24)     | 10 M @ 450 (18)      | 10 M @ 450 (18)      |
|                          | 2.13 (7.0)                   | 15 M @ 450 (18)                   | 15 M @ 600 (24)     | 10 M @ 450 (18)      | 10 M @ 600 (24)      | 15 M @ 300 (12)                | 15 M @ 450 (18)     | 15 M @ 600 (24)      | 15 M @ 750 (30)      |
|                          | 2.44 (8.0)                   | 15 M @ 300 (12)                   | 15 M @ 450 (18)     | 15 M @ 750 (30)      | 15 M @ 900 (36)      | 15 M @ 300 (12)                | 15 M @ 450 (18)     | 15 M @ 450 (18)      | 15 M @ 600 (24)      |
|                          | 2.74 (9.0)                   | 15 M @ 150 (6)                    | 15 M @ 450 (18)     | 15 M @ 600 (24)      | 15 M @ 750 (30)      | 15 M @ 150 (6)                 | 15 M @ 300 (12)     | 15 M @ 450 (18)      | 15 M @ 450 (18)      |
|                          | 3.05 (10.0)                  | 15 M @ 150 (6)                    | 15 M @ 300 (12)     | 15 M @ 450 (18)      | 15 M @ 600 (24)      | 15 M @ 150 (6)                 | 15 M @ 300 (12)     | 15 M @ 450 (18)      | 15 M @ 300 (12)      |
| 3.35<br>(11.0)           | 1.22 (4.0)                   | 15 M @ 600 (24)                   | 10 M @ 450 (18)     | 10 M @ 750 (30)      | 10 M @ 900 (36)      | 15 M @ 600 (24)                | 10 M @ 450 (18)     | 10 M @ 600 (24)      | 10 M @ 900 (36)      |
|                          | 1.53 (5.0)                   | 15 M @ 600 (24)                   | 15 M @ 900 (36)     | 10 M @ 600 (24)      | 10 M @ 750 (30)      | 15 M @ 450 (18)                | 15 M @ 750 (30)     | 10 M @ 450 (18)      | 10 M @ 600 (24)      |
|                          | 1.83 (6.0)                   | 15 M @ 450 (18)                   | 15 M @ 750 (30)     | 10 M @ 450 (18)      | 10 M @ 600 (24)      | 15 M @ 450 (18)                | 15 M @ 600 (24)     | 10 M @ 450 (18)      | 10 M @ 450 (18)      |
|                          | 2.13 (7.0)                   | 15 M @ 300 (12)                   | 15 M @ 600 (24)     | 15 M @ 750 (30)      | 15 M @ 900 (36)      | 15 M @ 300 (12)                | 15 M @ 450 (18)     | 15 M @ 600 (24)      | 15 M @ 750 (30)      |
|                          | 2.44 (8.0)                   | 15 M @ 300 (12)                   | 15 M @ 450 (18)     | 15 M @ 600 (24)      | 15 M @ 750 (30)      | 15 M @ 150 (6)                 | 15 M @ 450 (18)     | 15 M @ 450 (18)      | 15 M @ 600 (24)      |
|                          | 2.74 (9.0)                   | 15 M @ 150 (6)                    | 15 M @ 300 (12)     | 15 M @ 450 (18)      | 15 M @ 600 (24)      | 15 M @ 150 (6)                 | 15 M @ 300 (12)     | 15 M @ 450 (18)      | 15 M @ 450 (18)      |
|                          | 3.05 (10.0)                  | 15 M @ 150 (6)                    | 15 M @ 300 (12)     | 15 M @ 450 (18)      | 15 M @ 450 (18)      | 15 M @ 150 (6)                 | 15 M @ 150 (6)      | 15 M @ 300 (12)      | 15 M @ 300 (12)      |
| 3.66<br>(12.0)           | 1.22 (4.0)                   | 15 M @ 600 (24)                   | 10 M @ 450 (18)     | 10 M @ 750 (30)      | 10 M @ 900 (36)      | 15 M @ 600 (24)                | 15 M @ 750 (30)     | 10 M @ 600 (24)      | 10 M @ 900 (36)      |
|                          | 1.53 (5.0)                   | 15 M @ 600 (24)                   | 15 M @ 750 (30)     | 10 M @ 450 (18)      | 10 M @ 750 (30)      | 15 M @ 450 (18)                | 15 M @ 600 (24)     | 10 M @ 450 (18)      | 10 M @ 600 (24)      |
|                          | 1.83 (6.0)                   | 15 M @ 450 (18)                   | 15 M @ 600 (24)     | 10 M @ 450 (18)      | 10 M @ 600 (24)      | 15 M @ 300 (12)                | 15 M @ 600 (24)     | 15 M @ 750 (30)      | 15 M @ 900 (36)      |
|                          | 2.13 (7.0)                   | 15 M @ 300 (12)                   | 15 M @ 600 (24)     | 15 M @ 750 (30)      | 15 M @ 900 (36)      | 15 M @ 300 (12)                | 15 M @ 450 (18)     | 15 M @ 600 (24)      | 15 M @ 750 (30)      |
|                          | 2.44 (8.0)                   | 15 M @ 150 (6)                    | 15 M @ 450 (18)     | 15 M @ 600 (24)      | 15 M @ 750 (30)      | 15 M @ 150 (6)                 | 15 M @ 300 (12)     | 15 M @ 450 (18)      | 15 M @ 450 (18)      |
|                          | 2.74 (9.0)                   | 15 M @ 150 (6)                    | 15 M @ 300 (12)     | 15 M @ 450 (18)      | 15 M @ 600 (24)      | 15 M @ 150 (6)                 | 15 M @ 300 (12)     | 15 M @ 450 (18)      | 15 M @ 450 (18)      |
|                          | 3.05 (10.0)                  | 15 M @ 150 (6)                    | 15 M @ 300 (12)     | 15 M @ 300 (12)      | 15 M @ 450 (18)      | 15 M @ 150 (6)                 | 15 M @ 150 (6)      | 15 M @ 300 (12)      | 15 M @ 300 (12)      |
|                          | 3.35 (11.0)                  | 15 M @ 150 (6)                    | 15 M @ 300 (12)     | 15 M @ 300 (12)      | 15 M @ 300 (12)      | 15 M @ 150 (6)                 | 15 M @ 150 (6)      | 15 M @ 300 (12)      | 15 M @ 300 (12)      |
| Horizontal Reinforcement | Block Height of 12" and 18"  | 10 M @ 900 (36)                   | 10 M @ 900 (36)     | 10 M @ 900 (36)      | 10 M @ 900 (36)      | 10 M @ 900 (36)                | 10 M @ 900 (36)     | 10 M @ 900 (36)      | 10 M @ 900 (36)      |
|                          | Block Height of 16"          | 10 M @ 800 (32)                   | 10 M @ 800 (32)     | 10 M @ 800 (32)      | 10 M @ 800 (32)      | 10 M @ 800 (32)                | 10 M @ 800 (32)     | 10 M @ 800 (32)      | 10 M @ 800 (32)      |

**NOTES:**

- For highlighted data, where the below grade wall meets all the requirements of NBCC Part 9 for a solid concrete foundation wall and supports only wood frame construction above, a 20MPa unreinforced wall is adequate as per 2020 NBCC table 9.15.4.2.A. Provide the reinforcing shown for walls supporting ICF walls above or with brick veneer supported with the brick ledge form.
- Below grade walls supporting "Drained Earth" in accordance with 2020 NBCC 9.4.4.6 may be designed for an equivalent fluid pressure of 480 kg/m<sup>3</sup>.
- This table is to be used in conjunction with the "Design Limitations" and "Below Grade Reinforcement Placement" drawing.

INSULATING CONCRETE FORMS  
MANUFACTURERS ASSOCIATION



**Table B.1.1. Continued – Below Grade Wall Distributed Reinforcement for Seismic Zone Classification,  $S_{a,ICF} \leq 0.11$  and Hourly Wind Pressure,  $q_{1/50} \leq 1.05kPa$ , for ICF Walls with 6" Tie Spacing**

| Wall Height<br>m<br>(ft) | Backfill Height<br>m<br>(ft) | Vertical Steel (Size and Spacing) |                     |                      |                      |                                 |                     |                      |                      |
|--------------------------|------------------------------|-----------------------------------|---------------------|----------------------|----------------------|---------------------------------|---------------------|----------------------|----------------------|
|                          |                              | Backfill Equivalent Fluid Density |                     |                      |                      |                                 |                     |                      |                      |
|                          |                              | 960 kg/m <sup>3</sup> (60 pcf)    |                     |                      |                      | 1200 kg/m <sup>3</sup> (75 pcf) |                     |                      |                      |
|                          |                              | 150 mm (6")<br>25MPa Wall         | 200 mm (8")<br>Wall | 250 mm (10")<br>Wall | 300 mm (12")<br>Wall | 150 mm (6")<br>25MPa Wall       | 200 mm (8")<br>Wall | 250 mm (10")<br>Wall | 300 mm (12")<br>Wall |
| 2.44<br>(8.0)            | 1.22 (4.0)                   | 15 M @ 600 (24)                   | 10 M @ 450 (18)     | 10 M @ 750 (30)      | 10 M @ 900 (36)      | 15 M @ 600 (24)                 | 10 M @ 450 (18)     | 10 M @ 750 (30)      | 10 M @ 900 (36)      |
|                          | 1.53 (5.0)                   | 15 M @ 600 (24)                   | 10 M @ 450 (18)     | 10 M @ 600 (24)      | 10 M @ 900 (36)      | 15 M @ 450 (18)                 | 15 M @ 750 (30)     | 15 M @ 900 (36)      | 10 M @ 750 (30)      |
|                          | 1.83 (6.0)                   | 15 M @ 450 (18)                   | 15 M @ 600 (24)     | 10 M @ 450 (18)      | 10 M @ 600 (24)      | 15 M @ 450 (18)                 | 15 M @ 450 (18)     | 15 M @ 450 (18)      | 15 M @ 900 (36)      |
|                          | 2.13 (7.0)                   | 15 M @ 300 (12)                   | 15 M @ 450 (18)     | 15 M @ 600 (24)      | 15 M @ 900 (36)      | 15 M @ 300 (12)                 | 15 M @ 450 (18)     | 15 M @ 450 (18)      | 15 M @ 750 (30)      |
|                          | 2.44 (8.0)                   | 15 M @ 300 (12)                   | 15 M @ 450 (18)     | 15 M @ 450 (18)      | 15 M @ 750 (30)      | 15 M @ 150 (6)                  | 15 M @ 300 (12)     | 15 M @ 450 (18)      | 15 M @ 450 (18)      |
| 2.74<br>(9.0)            | 1.22 (4.0)                   | 15 M @ 600 (24)                   | 10 M @ 450 (18)     | 10 M @ 600 (24)      | 10 M @ 900 (36)      | 15 M @ 600 (24)                 | 15 M @ 900 (36)     | 10 M @ 450 (18)      | 10 M @ 750 (30)      |
|                          | 1.53 (5.0)                   | 15 M @ 450 (18)                   | 15 M @ 600 (24)     | 15 M @ 750 (30)      | 10 M @ 750 (30)      | 15 M @ 450 (18)                 | 15 M @ 600 (24)     | 10 M @ 600 (24)      | 10 M @ 600 (24)      |
|                          | 1.83 (6.0)                   | 15 M @ 450 (18)                   | 15 M @ 450 (18)     | 15 M @ 750 (30)      | 10 M @ 600 (24)      | 15 M @ 300 (12)                 | 15 M @ 450 (18)     | 15 M @ 600 (24)      | 15 M @ 900 (36)      |
|                          | 2.13 (7.0)                   | 15 M @ 300 (12)                   | 15 M @ 450 (18)     | 15 M @ 600 (24)      | 15 M @ 900 (36)      | 15 M @ 300 (12)                 | 15 M @ 450 (18)     | 15 M @ 450 (18)      | 15 M @ 600 (24)      |
|                          | 2.44 (8.0)                   | 15 M @ 150 (6)                    | 15 M @ 300 (12)     | 15 M @ 450 (18)      | 15 M @ 450 (18)      | 15 M @ 150 (6)                  | 15 M @ 300 (12)     | 15 M @ 450 (18)      | 15 M @ 450 (18)      |
| 3.05<br>(10.0)           | 1.22 (4.0)                   | 15 M @ 600 (24)                   | 10 M @ 450 (18)     | 10 M @ 600 (24)      | 10 M @ 900 (36)      | 15 M @ 600 (24)                 | 15 M @ 750 (30)     | 15 M @ 900 (36)      | 10 M @ 750 (30)      |
|                          | 1.53 (5.0)                   | 15 M @ 450 (18)                   | 15 M @ 600 (24)     | 10 M @ 450 (18)      | 10 M @ 600 (24)      | 15 M @ 450 (18)                 | 15 M @ 600 (24)     | 15 M @ 600 (24)      | 10 M @ 450 (18)      |
|                          | 1.83 (6.0)                   | 15 M @ 450 (18)                   | 15 M @ 450 (18)     | 15 M @ 750 (30)      | 15 M @ 900 (36)      | 15 M @ 300 (12)                 | 15 M @ 450 (18)     | 15 M @ 600 (24)      | 15 M @ 750 (30)      |
|                          | 2.13 (7.0)                   | 15 M @ 300 (12)                   | 15 M @ 450 (18)     | 15 M @ 450 (18)      | 15 M @ 600 (24)      | 15 M @ 150 (6)                  | 15 M @ 300 (12)     | 15 M @ 450 (18)      | 15 M @ 450 (18)      |
|                          | 2.44 (8.0)                   | 15 M @ 150 (6)                    | 15 M @ 300 (12)     | 15 M @ 450 (18)      | 15 M @ 450 (18)      | 15 M @ 150 (6)                  | 15 M @ 300 (12)     | 15 M @ 300 (12)      | 15 M @ 300 (12)      |
| 3.35<br>(11.0)           | 1.22 (4.0)                   | 15 M @ 600 (24)                   | 15 M @ 600 (24)     | 10 M @ 600 (24)      | 10 M @ 750 (30)      | 15 M @ 600 (24)                 | 15 M @ 750 (30)     | 15 M @ 900 (36)      | 10 M @ 750 (30)      |
|                          | 1.53 (5.0)                   | 15 M @ 450 (18)                   | 15 M @ 600 (24)     | 15 M @ 900 (36)      | 10 M @ 450 (18)      | 15 M @ 600 (24)                 | 15 M @ 600 (24)     | 15 M @ 600 (24)      | 10 M @ 450 (18)      |
|                          | 1.83 (6.0)                   | 15 M @ 450 (18)                   | 15 M @ 450 (18)     | 15 M @ 600 (24)      | 15 M @ 750 (30)      | 15 M @ 300 (12)                 | 15 M @ 450 (18)     | 15 M @ 600 (24)      | 15 M @ 600 (24)      |
|                          | 2.13 (7.0)                   | 15 M @ 300 (12)                   | 15 M @ 450 (18)     | 15 M @ 450 (18)      | 15 M @ 600 (24)      | 15 M @ 150 (6)                  | 15 M @ 300 (12)     | 15 M @ 450 (18)      | 15 M @ 450 (18)      |
|                          | 2.44 (8.0)                   | 15 M @ 150 (6)                    | 15 M @ 300 (12)     | 15 M @ 450 (18)      | 15 M @ 450 (18)      | 15 M @ 150 (6)                  | 15 M @ 300 (12)     | 15 M @ 300 (12)      | 15 M @ 300 (12)      |
| 3.66<br>(12.0)           | 1.22 (4.0)                   | 15 M @ 600 (24)                   | 15 M @ 600 (24)     | 10 M @ 450 (18)      | 10 M @ 750 (30)      | 15 M @ 450 (18)                 | 15 M @ 750 (30)     | 15 M @ 900 (36)      | 10 M @ 600 (24)      |
|                          | 1.53 (5.0)                   | 15 M @ 450 (18)                   | 15 M @ 450 (18)     | 15 M @ 750 (30)      | 10 M @ 450 (18)      | 15 M @ 450 (18)                 | 15 M @ 450 (18)     | 15 M @ 750 (30)      | 15 M @ 900 (36)      |
|                          | 1.83 (6.0)                   | 15 M @ 300 (12)                   | 15 M @ 450 (18)     | 15 M @ 600 (24)      | 15 M @ 750 (30)      | 15 M @ 300 (12)                 | 15 M @ 450 (18)     | 15 M @ 450 (18)      | 15 M @ 600 (24)      |
|                          | 2.13 (7.0)                   | 15 M @ 150 (6)                    | 15 M @ 300 (12)     | 15 M @ 450 (18)      | 15 M @ 450 (18)      | 15 M @ 150 (6)                  | 15 M @ 300 (12)     | 15 M @ 450 (18)      | 15 M @ 450 (18)      |
|                          | 2.44 (8.0)                   | 15 M @ 150 (6)                    | 15 M @ 300 (12)     | 15 M @ 450 (18)      | 15 M @ 300 (12)      | 15 M @ 150 (6)                  | 15 M @ 300 (12)     | 15 M @ 300 (12)      | 15 M @ 300 (12)      |
| Horizontal Reinforcement | Block Height of 12" and 18"  | 10 M @ 900 (36)                   | 10 M @ 900 (36)     | 10 M @ 900 (36)      | 10 M @ 900 (36)      | 10 M @ 900 (36)                 | 10 M @ 900 (36)     | 10 M @ 900 (36)      | 10 M @ 900 (36)      |
|                          | Block Height of 16"          | 10 M @ 800 (32)                   | 10 M @ 800 (32)     | 10 M @ 800 (32)      | 10 M @ 800 (32)      | 10 M @ 800 (32)                 | 10 M @ 800 (32)     | 10 M @ 800 (32)      | 10 M @ 800 (32)      |

**NOTES:**

- For highlighted data, where the below grade wall meets all the requirements of NBCC Part 9 for a solid concrete foundation wall and supports only wood frame construction above, a 20MPa unreinforced wall is adequate as per 2020 NBCC table 9.15.4.2.A. Provide the reinforcing shown for walls supporting ICF walls above or with brick veneer supported with the brick ledge form.
- Below grade walls supporting "Drained Earth" in accordance with 2020 NBCC 9.4.4.6 may be designed for an equivalent fluid pressure of 480 kg/m<sup>3</sup>.
- This table is to be used in conjunction with the "Design Limitations" and "Below Grade Reinforcement Placement" drawing.

INSULATING CONCRETE FORMS  
MANUFACTURERS ASSOCIATION



**Table B.1.2.– Below Grade Wall Distributed Reinforcement for Seismic Zone Classification,  $S_{a,ICF} \leq 0.11$  and Hourly Wind Pressure,  $q_{1/50} \leq 1.05kPa$ , for ICF Walls with 8" Tie Spacing**

| Wall Height<br>m<br>(ft)    | Backfill Height<br>m<br>(ft) | Vertical Steel (Size and Spacing) |                     |                      |                      |                                |                     |                      |                      |
|-----------------------------|------------------------------|-----------------------------------|---------------------|----------------------|----------------------|--------------------------------|---------------------|----------------------|----------------------|
|                             |                              | 480 kg/m <sup>3</sup> (30 pcf)    |                     |                      |                      | 720 kg/m <sup>3</sup> (45 pcf) |                     |                      |                      |
|                             |                              | 150 mm (6")<br>25MPa Wall         | 200 mm (8")<br>Wall | 250 mm (10")<br>Wall | 300 mm (12")<br>Wall | 150 mm (6")<br>25MPa Wall      | 200 mm (8")<br>Wall | 250 mm (10")<br>Wall | 300 mm (12")<br>Wall |
| 2.44<br>(8.0)               | 1.22 (4.0)                   | 10 M @ 400 (16)                   | 10 M @ 600 (24)     | 10 M @ 800 (32)      | 10 M @ 800 (32)      | 10 M @ 400 (16)                | 10 M @ 600 (24)     | 10 M @ 800 (32)      | 10 M @ 800 (32)      |
|                             | 1.53 (5.0)                   | 10 M @ 400 (16)                   | 10 M @ 600 (24)     | 10 M @ 800 (32)      | 10 M @ 800 (32)      | 15 M @ 600 (24)                | 10 M @ 400 (16)     | 10 M @ 800 (32)      | 10 M @ 800 (32)      |
|                             | 1.83 (6.0)                   | 15 M @ 600 (24)                   | 10 M @ 400 (16)     | 10 M @ 600 (24)      | 10 M @ 800 (32)      | 15 M @ 400 (16)                | 15 M @ 600 (24)     | 10 M @ 600 (24)      | 10 M @ 800 (32)      |
|                             | 2.13 (7.0)                   | 15 M @ 400 (16)                   | 15 M @ 600 (24)     | 10 M @ 600 (24)      | 10 M @ 600 (24)      | 15 M @ 400 (16)                | 15 M @ 600 (24)     | 10 M @ 400 (16)      | 10 M @ 600 (24)      |
|                             | 2.44 (8.0)                   | 15 M @ 400 (16)                   | 15 M @ 600 (24)     | 10 M @ 400 (16)      | 10 M @ 600 (24)      | 15 M @ 400 (16)                | 15 M @ 400 (16)     | 15 M @ 600 (24)      | 15 M @ 800 (32)      |
| 2.74<br>(9.0)               | 1.22 (4.0)                   | 15 M @ 800 (32)                   | 10 M @ 600 (24)     | 10 M @ 800 (32)      | 10 M @ 800 (32)      | 15 M @ 800 (32)                | 10 M @ 600 (24)     | 10 M @ 800 (32)      | 10 M @ 800 (32)      |
|                             | 1.53 (5.0)                   | 15 M @ 800 (32)                   | 10 M @ 400 (16)     | 10 M @ 800 (32)      | 10 M @ 800 (32)      | 15 M @ 600 (24)                | 10 M @ 400 (16)     | 10 M @ 600 (24)      | 10 M @ 800 (32)      |
|                             | 1.83 (6.0)                   | 15 M @ 600 (24)                   | 15 M @ 800 (32)     | 10 M @ 600 (24)      | 10 M @ 800 (32)      | 15 M @ 400 (16)                | 15 M @ 600 (24)     | 10 M @ 400 (16)      | 10 M @ 600 (24)      |
|                             | 2.13 (7.0)                   | 15 M @ 400 (16)                   | 15 M @ 600 (24)     | 10 M @ 400 (16)      | 10 M @ 600 (24)      | 15 M @ 400 (16)                | 15 M @ 400 (16)     | 15 M @ 600 (24)      | 15 M @ 800 (32)      |
|                             | 2.44 (8.0)                   | 15 M @ 400 (16)                   | 15 M @ 600 (24)     | 15 M @ 800 (32)      | 15 M @ 800 (32)      | 15 M @ 200 (8)                 | 15 M @ 400 (16)     | 15 M @ 600 (24)      | 15 M @ 800 (32)      |
| 3.05<br>(10.0)              | 1.22 (4.0)                   | 15 M @ 600 (24)                   | 10 M @ 600 (24)     | 10 M @ 800 (32)      | 10 M @ 800 (32)      | 15 M @ 600 (24)                | 10 M @ 400 (16)     | 10 M @ 600 (24)      | 10 M @ 800 (32)      |
|                             | 1.53 (5.0)                   | 15 M @ 600 (24)                   | 15 M @ 800 (32)     | 10 M @ 600 (24)      | 10 M @ 800 (32)      | 15 M @ 600 (24)                | 15 M @ 800 (32)     | 10 M @ 600 (24)      | 10 M @ 600 (24)      |
|                             | 1.83 (6.0)                   | 15 M @ 400 (16)                   | 15 M @ 600 (24)     | 10 M @ 600 (24)      | 10 M @ 600 (24)      | 15 M @ 400 (16)                | 15 M @ 600 (24)     | 10 M @ 400 (16)      | 10 M @ 400 (16)      |
|                             | 2.13 (7.0)                   | 15 M @ 400 (16)                   | 15 M @ 600 (24)     | 10 M @ 400 (16)      | 10 M @ 600 (24)      | 15 M @ 400 (16)                | 15 M @ 400 (16)     | 15 M @ 600 (24)      | 15 M @ 800 (32)      |
|                             | 2.44 (8.0)                   | 15 M @ 400 (16)                   | 15 M @ 400 (16)     | 15 M @ 600 (24)      | 15 M @ 800 (32)      | 15 M @ 200 (8)                 | 15 M @ 400 (16)     | 15 M @ 400 (16)      | 15 M @ 600 (24)      |
| 3.35<br>(11.0)              | 1.22 (4.0)                   | 15 M @ 600 (24)                   | 10 M @ 400 (16)     | 10 M @ 800 (32)      | 10 M @ 800 (32)      | 15 M @ 600 (24)                | 10 M @ 400 (16)     | 10 M @ 600 (24)      | 10 M @ 800 (32)      |
|                             | 1.53 (5.0)                   | 15 M @ 600 (24)                   | 15 M @ 800 (32)     | 10 M @ 600 (24)      | 10 M @ 800 (32)      | 15 M @ 400 (16)                | 15 M @ 600 (24)     | 10 M @ 400 (16)      | 10 M @ 600 (24)      |
|                             | 1.83 (6.0)                   | 15 M @ 400 (16)                   | 15 M @ 600 (24)     | 10 M @ 400 (16)      | 10 M @ 600 (24)      | 15 M @ 400 (16)                | 15 M @ 600 (24)     | 10 M @ 400 (16)      | 10 M @ 400 (16)      |
|                             | 2.13 (7.0)                   | 15 M @ 400 (16)                   | 15 M @ 600 (24)     | 15 M @ 600 (24)      | 15 M @ 800 (32)      | 15 M @ 400 (16)                | 15 M @ 400 (16)     | 15 M @ 600 (24)      | 15 M @ 800 (32)      |
|                             | 2.44 (8.0)                   | 15 M @ 200 (8)                    | 15 M @ 400 (16)     | 15 M @ 600 (24)      | 15 M @ 800 (32)      | 15 M @ 200 (8)                 | 15 M @ 400 (16)     | 15 M @ 400 (16)      | 15 M @ 600 (24)      |
| 3.66<br>(12.0)              | 1.22 (4.0)                   | 15 M @ 600 (24)                   | 10 M @ 400 (16)     | 10 M @ 600 (24)      | 10 M @ 800 (32)      | 15 M @ 600 (24)                | 15 M @ 800 (32)     | 10 M @ 600 (24)      | 10 M @ 800 (32)      |
|                             | 1.53 (5.0)                   | 15 M @ 600 (24)                   | 15 M @ 800 (32)     | 10 M @ 400 (16)      | 10 M @ 600 (24)      | 15 M @ 400 (16)                | 15 M @ 600 (24)     | 10 M @ 400 (16)      | 10 M @ 600 (24)      |
|                             | 1.83 (6.0)                   | 15 M @ 400 (16)                   | 15 M @ 600 (24)     | 10 M @ 400 (16)      | 10 M @ 600 (24)      | 15 M @ 400 (16)                | 15 M @ 600 (24)     | 15 M @ 800 (32)      | 15 M @ 800 (32)      |
|                             | 2.13 (7.0)                   | 15 M @ 400 (16)                   | 15 M @ 600 (24)     | 15 M @ 600 (24)      | 15 M @ 800 (32)      | 15 M @ 200 (8)                 | 15 M @ 400 (16)     | 15 M @ 600 (24)      | 15 M @ 600 (24)      |
|                             | 2.44 (8.0)                   | 15 M @ 200 (8)                    | 15 M @ 400 (16)     | 15 M @ 600 (24)      | 15 M @ 600 (24)      | 15 M @ 200 (8)                 | 15 M @ 400 (16)     | 15 M @ 400 (16)      | 15 M @ 400 (16)      |
| Horizontal<br>Reinforcement | Block Height of 12" and 18"  | 10 M @ 900 (36)                   | 10 M @ 900 (36)     | 10 M @ 900 (36)      | 10 M @ 900 (36)      | 10 M @ 900 (36)                | 10 M @ 900 (36)     | 10 M @ 900 (36)      | 10 M @ 900 (36)      |
|                             | Block Height of 16"          | 10 M @ 800 (32)                   | 10 M @ 800 (32)     | 10 M @ 800 (32)      | 10 M @ 800 (32)      | 10 M @ 800 (32)                | 10 M @ 800 (32)     | 10 M @ 800 (32)      | 10 M @ 800 (32)      |

**NOTES:**

- For highlighted data, where the below grade wall meets all the requirements of NBCC Part 9 for a solid concrete foundation wall and supports only wood frame construction above, a 20MPa unreinforced wall is adequate as per 2020 NBCC table 9.15.4.2.A. Provide the reinforcing shown for walls supporting ICF walls above or with brick veneer supported with the brick ledge form.
- Below grade walls supporting "Drained Earth" in accordance with 2020 NBCC 9.4.4.6 may be designed for an equivalent fluid pressure of 480 kg/m<sup>3</sup>.
- This table is to be used in conjunction with the "Design Limitations" and "Below Grade Reinforcement Placement" drawing.



**Table B.1.2. Continued – Below Grade Wall Distributed Reinforcement for Seismic Zone Classification,  $S_{a,ICF} \leq 0.11$  and Hourly Wind Pressure,  $q_{1/50} \leq 1.05\text{kPa}$ , for ICF Walls with 8" Tie Spacing**

| Wall Height<br>m<br>(ft) | Backfill Height<br>m<br>(ft) | Vertical Steel (Size and Spacing) |                     |                      |                      |                                 |                     |                      |                      |
|--------------------------|------------------------------|-----------------------------------|---------------------|----------------------|----------------------|---------------------------------|---------------------|----------------------|----------------------|
|                          |                              | Backfill Equivalent Fluid Density |                     |                      |                      |                                 |                     |                      |                      |
|                          |                              | 960 kg/m <sup>3</sup> (60 pcf)    |                     |                      |                      | 1200 kg/m <sup>3</sup> (75 pcf) |                     |                      |                      |
|                          |                              | 150 mm (6")<br>25MPa Wall         | 200 mm (8")<br>Wall | 250 mm (10")<br>Wall | 300 mm (12")<br>Wall | 150 mm (6")<br>25MPa Wall       | 200 mm (8")<br>Wall | 250 mm (10")<br>Wall | 300 mm (12")<br>Wall |
| 2.44<br>(8.0)            | 1.22 (4.0)                   | 15 M @ 600 (24)                   | 10 M @ 400 (16)     | 10 M @ 800 (32)      | 10 M @ 800 (32)      | 15 M @ 600 (24)                 | 10 M @ 400 (16)     | 10 M @ 600 (24)      | 10 M @ 800 (32)      |
|                          | 1.53 (5.0)                   | 15 M @ 400 (16)                   | 10 M @ 400 (16)     | 10 M @ 600 (24)      | 10 M @ 800 (32)      | 15 M @ 400 (16)                 | 15 M @ 800 (32)     | 15 M @ 800 (32)      | 10 M @ 600 (24)      |
|                          | 1.83 (6.0)                   | 15 M @ 400 (16)                   | 15 M @ 600 (24)     | 10 M @ 400 (16)      | 10 M @ 600 (24)      | 15 M @ 400 (16)                 | 15 M @ 400 (16)     | 15 M @ 400 (16)      | 15 M @ 600 (24)      |
|                          | 2.13 (7.0)                   | 15 M @ 400 (16)                   | 15 M @ 400 (16)     | 15 M @ 600 (24)      | 15 M @ 800 (32)      | 15 M @ 200 (8)                  | 15 M @ 400 (16)     | 15 M @ 400 (16)      | 15 M @ 600 (24)      |
|                          | 2.44 (8.0)                   | 15 M @ 200 (8)                    | 15 M @ 400 (16)     | 15 M @ 400 (16)      | 15 M @ 600 (24)      | 15 M @ 200 (8)                  | 15 M @ 400 (16)     | 15 M @ 400 (16)      | 15 M @ 400 (16)      |
| 2.74<br>(9.0)            | 1.22 (4.0)                   | 15 M @ 600 (24)                   | 10 M @ 400 (16)     | 10 M @ 600 (24)      | 10 M @ 800 (32)      | 15 M @ 600 (24)                 | 15 M @ 800 (32)     | 10 M @ 400 (16)      | 10 M @ 800 (32)      |
|                          | 1.53 (5.0)                   | 15 M @ 400 (16)                   | 15 M @ 600 (24)     | 15 M @ 800 (32)      | 10 M @ 800 (32)      | 15 M @ 400 (16)                 | 15 M @ 600 (24)     | 15 M @ 800 (32)      | 10 M @ 600 (24)      |
|                          | 1.83 (6.0)                   | 15 M @ 400 (16)                   | 15 M @ 400 (16)     | 15 M @ 800 (32)      | 10 M @ 600 (24)      | 15 M @ 400 (16)                 | 15 M @ 400 (16)     | 15 M @ 600 (24)      | 15 M @ 800 (32)      |
|                          | 2.13 (7.0)                   | 15 M @ 200 (8)                    | 15 M @ 400 (16)     | 15 M @ 600 (24)      | 15 M @ 600 (24)      | 15 M @ 200 (8)                  | 15 M @ 400 (16)     | 15 M @ 400 (16)      | 15 M @ 600 (24)      |
|                          | 2.44 (8.0)                   | 15 M @ 200 (8)                    | 15 M @ 400 (16)     | 15 M @ 400 (16)      | 15 M @ 400 (16)      | 15 M @ 200 (8)                  | 15 M @ 400 (16)     | 15 M @ 400 (16)      | 15 M @ 600 (24)      |
|                          | 2.74 (9.0)                   | 15 M @ 200 (8)                    | 15 M @ 200 (8)      | 15 M @ 400 (16)      | 15 M @ 400 (16)      | 15 M @ 200 (8)                  | 15 M @ 400 (16)     | 15 M @ 400 (16)      | 15 M @ 200 (8)       |
| 3.05<br>(10.0)           | 1.22 (4.0)                   | 15 M @ 600 (24)                   | 10 M @ 400 (16)     | 10 M @ 600 (24)      | 10 M @ 800 (32)      | 15 M @ 600 (24)                 | 15 M @ 800 (32)     | 15 M @ 800 (32)      | 10 M @ 800 (32)      |
|                          | 1.53 (5.0)                   | 15 M @ 400 (16)                   | 15 M @ 600 (24)     | 10 M @ 400 (16)      | 10 M @ 600 (24)      | 15 M @ 400 (16)                 | 15 M @ 600 (24)     | 15 M @ 800 (32)      | 10 M @ 600 (24)      |
|                          | 1.83 (6.0)                   | 15 M @ 400 (16)                   | 15 M @ 400 (16)     | 15 M @ 600 (24)      | 15 M @ 800 (32)      | 15 M @ 400 (16)                 | 15 M @ 400 (16)     | 15 M @ 600 (24)      | 15 M @ 600 (24)      |
|                          | 2.13 (7.0)                   | 15 M @ 200 (8)                    | 15 M @ 400 (16)     | 15 M @ 400 (16)      | 15 M @ 600 (24)      | 15 M @ 200 (8)                  | 15 M @ 400 (16)     | 15 M @ 400 (16)      | 15 M @ 400 (16)      |
|                          | 2.44 (8.0)                   | 15 M @ 200 (8)                    | 15 M @ 400 (16)     | 15 M @ 400 (16)      | 15 M @ 400 (16)      | 15 M @ 200 (8)                  | 15 M @ 200 (8)      | 15 M @ 400 (16)      | 15 M @ 400 (16)      |
|                          | 2.74 (9.0)                   | 15 M @ 200 (8)                    | 15 M @ 200 (8)      | 15 M @ 400 (16)      | 15 M @ 400 (16)      | 15 M @ 200 (8)                  | 15 M @ 400 (16)     | 15 M @ 400 (16)      | 15 M @ 200 (8)       |
|                          | 3.05 (10.0)                  | 15 M @ 200 (8)                    | 15 M @ 200 (8)      | 15 M @ 200 (8)       | 15 M @ 200 (8)       | 15 M @ 200 (8)                  | 15 M @ 200 (8)      | 15 M @ 200 (8)       | 15 M @ 200 (8)       |
| 3.35<br>(11.0)           | 1.22 (4.0)                   | 15 M @ 600 (24)                   | 15 M @ 600 (24)     | 10 M @ 600 (24)      | 10 M @ 800 (32)      | 15 M @ 600 (24)                 | 15 M @ 800 (32)     | 15 M @ 800 (32)      | 10 M @ 600 (24)      |
|                          | 1.53 (5.0)                   | 15 M @ 400 (16)                   | 15 M @ 600 (24)     | 15 M @ 800 (32)      | 10 M @ 400 (16)      | 15 M @ 400 (16)                 | 15 M @ 600 (24)     | 15 M @ 800 (32)      | 10 M @ 400 (16)      |
|                          | 1.83 (6.0)                   | 15 M @ 400 (16)                   | 15 M @ 400 (16)     | 15 M @ 600 (24)      | 15 M @ 800 (32)      | 15 M @ 200 (8)                  | 15 M @ 400 (16)     | 15 M @ 600 (24)      | 15 M @ 600 (24)      |
|                          | 2.13 (7.0)                   | 15 M @ 200 (8)                    | 15 M @ 400 (16)     | 15 M @ 400 (16)      | 15 M @ 600 (24)      | 15 M @ 200 (8)                  | 15 M @ 400 (16)     | 15 M @ 400 (16)      | 15 M @ 400 (16)      |
|                          | 2.44 (8.0)                   | 15 M @ 200 (8)                    | 15 M @ 200 (8)      | 15 M @ 400 (16)      | 15 M @ 400 (16)      | 15 M @ 200 (8)                  | 15 M @ 400 (16)     | 15 M @ 400 (16)      | 15 M @ 200 (8)       |
|                          | 2.74 (9.0)                   | 15 M @ 200 (8)                    | 15 M @ 200 (8)      | 15 M @ 400 (16)      | 15 M @ 400 (16)      | 15 M @ 200 (8)                  | 15 M @ 200 (8)      | 15 M @ 200 (8)       | 15 M @ 200 (8)       |
|                          | 3.05 (10.0)                  | 15 M @ 200 (8)                    | 15 M @ 200 (8)      | 15 M @ 200 (8)       | 15 M @ 200 (8)       | 15 M @ 200 (8)                  | 15 M @ 200 (8)      | 15 M @ 200 (8)       | 15 M @ 200 (8)       |
|                          | 3.35 (11.0)                  | 15 M @ 200 (8)                    | 15 M @ 200 (8)      | 15 M @ 200 (8)       | 15 M @ 200 (8)       | 15 M @ 200 (8)                  | 15 M @ 200 (8)      | 15 M @ 200 (8)       | 15 M @ 200 (8)       |
| 3.66<br>(12.0)           | 1.22 (4.0)                   | 15 M @ 600 (24)                   | 15 M @ 600 (24)     | 10 M @ 400 (16)      | 10 M @ 800 (32)      | 15 M @ 400 (16)                 | 15 M @ 600 (24)     | 15 M @ 800 (32)      | 10 M @ 600 (24)      |
|                          | 1.53 (5.0)                   | 15 M @ 400 (16)                   | 15 M @ 400 (16)     | 15 M @ 800 (32)      | 10 M @ 400 (16)      | 15 M @ 400 (16)                 | 15 M @ 400 (16)     | 15 M @ 600 (24)      | 15 M @ 800 (32)      |
|                          | 1.83 (6.0)                   | 15 M @ 400 (16)                   | 15 M @ 400 (16)     | 15 M @ 600 (24)      | 15 M @ 800 (32)      | 15 M @ 200 (8)                  | 15 M @ 400 (16)     | 15 M @ 400 (16)      | 15 M @ 600 (24)      |
|                          | 2.13 (7.0)                   | 15 M @ 200 (8)                    | 15 M @ 400 (16)     | 15 M @ 400 (16)      | 15 M @ 400 (16)      | 15 M @ 200 (8)                  | 15 M @ 400 (16)     | 15 M @ 400 (16)      | 15 M @ 400 (16)      |
|                          | 2.44 (8.0)                   | 15 M @ 200 (8)                    | 15 M @ 200 (8)      | 15 M @ 400 (16)      | 15 M @ 400 (16)      | 15 M @ 200 (8)                  | 15 M @ 400 (16)     | 15 M @ 400 (16)      | 15 M @ 200 (8)       |
|                          | 2.74 (9.0)                   | 15 M @ 200 (8)                    | 15 M @ 200 (8)      | 15 M @ 200 (8)       | 15 M @ 200 (8)       | 15 M @ 200 (8)                  | 15 M @ 200 (8)      | 15 M @ 200 (8)       | 15 M @ 200 (8)       |
|                          | 3.05 (10.0)                  | 15 M @ 200 (8)                    | 15 M @ 200 (8)      | 15 M @ 200 (8)       | 15 M @ 200 (8)       | 15 M @ 200 (8)                  | 15 M @ 200 (8)      | 15 M @ 200 (8)       | 15 M @ 200 (8)       |
|                          | 3.35 (11.0)                  | 15 M @ 200 (8)                    | 15 M @ 200 (8)      | 15 M @ 200 (8)       | 15 M @ 200 (8)       | 15 M @ 200 (8)                  | 15 M @ 200 (8)      | 15 M @ 200 (8)       | 15 M @ 200 (8)       |
|                          | 3.66 (12.0)                  | 15 M @ 200 (8)                    | 15 M @ 200 (8)      | 15 M @ 200 (8)       | 15 M @ 200 (8)       | 15 M @ 200 (8)                  | 15 M @ 200 (8)      | 15 M @ 200 (8)       | 15 M @ 200 (8)       |
| Horizontal Reinforcement | Block Height of 12" and 18"  | 10 M @ 900 (36)                   | 10 M @ 900 (36)     | 10 M @ 900 (36)      | 10 M @ 900 (36)      | 10 M @ 900 (36)                 | 10 M @ 900 (36)     | 10 M @ 900 (36)      | 10 M @ 900 (36)      |
|                          | Block Height of 16"          | 10 M @ 800 (32)                   | 10 M @ 800 (32)     | 10 M @ 800 (32)      | 10 M @ 800 (32)      | 10 M @ 800 (32)                 | 10 M @ 800 (32)     | 10 M @ 800 (32)      | 10 M @ 800 (32)      |

NOTES:

- For highlighted data, where the below grade wall meets all the requirements of NBCC Part 9 for a solid concrete foundation wall and supports only wood frame construction above, a 20MPa unreinforced wall is adequate as per 2020 NBCC table 9.15.4.2.A. Provide the reinforcing shown for walls supporting ICF walls above or with brick veneer supported with the brick ledge form.
- Below grade walls supporting "Drained Earth" in accordance with 2020 NBCC 9.4.4.6 may be designed for an equivalent fluid pressure of 480 kg/m<sup>3</sup>.
- This table is to be used in conjunction with the "Design Limitations" and "Below Grade Reinforcement Placement" drawing.



**Table B.2.1. – Below Grade Wall Distributed Reinforcement for Seismic Zone Classification, 0.11 < S<sub>a,ICF</sub> ≤ 0.16 and Hourly Wind Pressure, q<sub>1/50</sub> ≤ 1.05kPa, for ICF Walls with 6” Tie Spacing**

| Wall Height<br>m<br>(ft) | Backfill Height<br>m<br>(ft) | Vertical Steel (Size and Spacing) |                     |                      |                      |                                |                     |                      |                      |
|--------------------------|------------------------------|-----------------------------------|---------------------|----------------------|----------------------|--------------------------------|---------------------|----------------------|----------------------|
|                          |                              | Backfill Equivalent Fluid Density |                     |                      |                      |                                |                     |                      |                      |
|                          |                              | 480 kg/m <sup>3</sup> (30 pcf)    |                     |                      |                      | 720 kg/m <sup>3</sup> (45 pcf) |                     |                      |                      |
|                          |                              | 150 mm (6")<br>25MPa Wall         | 200 mm (8")<br>Wall | 250 mm (10")<br>Wall | 300 mm (12")<br>Wall | 150 mm (6")<br>25MPa Wall      | 200 mm (8")<br>Wall | 250 mm (10")<br>Wall | 300 mm (12")<br>Wall |
| 2.44<br>(8.0)            | 1.22 (4.0)                   | 10 M @ 450 (18)                   | 10 M @ 600 (24)     | 10 M @ 450 (18)      | 10 M @ 450 (18)      | 15 M @ 450 (18)                | 10 M @ 450 (18)     | 10 M @ 450 (18)      | 10 M @ 450 (18)      |
|                          | 1.53 (5.0)                   | 15 M @ 600 (24)                   | 15 M @ 600 (24)     | 10 M @ 450 (18)      | 10 M @ 450 (18)      | 15 M @ 450 (18)                | 15 M @ 600 (24)     | 10 M @ 450 (18)      | 10 M @ 450 (18)      |
|                          | 1.83 (6.0)                   | 15 M @ 450 (18)                   | 15 M @ 600 (24)     | 15 M @ 600 (24)      | 15 M @ 600 (24)      | 15 M @ 450 (18)                | 15 M @ 450 (18)     | 15 M @ 600 (24)      | 15 M @ 600 (24)      |
|                          | 2.13 (7.0)                   | 15 M @ 300 (12)                   | 15 M @ 450 (18)     | 15 M @ 600 (24)      | 15 M @ 600 (24)      | 15 M @ 300 (12)                | 15 M @ 450 (18)     | 15 M @ 450 (18)      | 15 M @ 600 (24)      |
|                          | 2.44 (8.0)                   | 15 M @ 300 (12)                   | 15 M @ 450 (18)     | 15 M @ 600 (24)      | 15 M @ 600 (24)      | 15 M @ 150 (6)                 | 15 M @ 450 (18)     | 15 M @ 450 (18)      | 15 M @ 600 (24)      |
| 2.74<br>(9.0)            | 1.22 (4.0)                   | 15 M @ 600 (24)                   | 10 M @ 450 (18)     | 10 M @ 450 (18)      | 10 M @ 450 (18)      | 15 M @ 600 (24)                | 10 M @ 450 (18)     | 10 M @ 450 (18)      | 10 M @ 450 (18)      |
|                          | 1.53 (5.0)                   | 15 M @ 450 (18)                   | 15 M @ 600 (24)     | 10 M @ 450 (18)      | 10 M @ 450 (18)      | 15 M @ 450 (18)                | 15 M @ 600 (24)     | 10 M @ 450 (18)      | 10 M @ 450 (18)      |
|                          | 1.83 (6.0)                   | 15 M @ 450 (18)                   | 15 M @ 600 (24)     | 15 M @ 600 (24)      | 15 M @ 600 (24)      | 15 M @ 300 (12)                | 15 M @ 450 (18)     | 15 M @ 600 (24)      | 15 M @ 600 (24)      |
|                          | 2.13 (7.0)                   | 15 M @ 300 (12)                   | 15 M @ 450 (18)     | 15 M @ 600 (24)      | 15 M @ 600 (24)      | 15 M @ 300 (12)                | 15 M @ 450 (18)     | 15 M @ 600 (24)      | 15 M @ 600 (24)      |
|                          | 2.44 (8.0)                   | 15 M @ 150 (6)                    | 15 M @ 300 (12)     | 15 M @ 450 (18)      | 15 M @ 600 (24)      | 15 M @ 150 (6)                 | 15 M @ 300 (12)     | 15 M @ 450 (18)      | 15 M @ 600 (24)      |
| 3.05<br>(10.0)           | 1.22 (4.0)                   | 15 M @ 600 (24)                   | 10 M @ 450 (18)     | 10 M @ 450 (18)      | 10 M @ 450 (18)      | 15 M @ 600 (24)                | 10 M @ 450 (18)     | 10 M @ 450 (18)      | 10 M @ 450 (18)      |
|                          | 1.53 (5.0)                   | 15 M @ 450 (18)                   | 15 M @ 600 (24)     | 10 M @ 450 (18)      | 10 M @ 450 (18)      | 15 M @ 450 (18)                | 15 M @ 600 (24)     | 10 M @ 450 (18)      | 10 M @ 450 (18)      |
|                          | 1.83 (6.0)                   | 15 M @ 300 (12)                   | 15 M @ 450 (18)     | 15 M @ 600 (24)      | 15 M @ 600 (24)      | 15 M @ 300 (12)                | 15 M @ 450 (18)     | 15 M @ 600 (24)      | 15 M @ 600 (24)      |
|                          | 2.13 (7.0)                   | 15 M @ 300 (12)                   | 15 M @ 450 (18)     | 15 M @ 600 (24)      | 15 M @ 600 (24)      | 15 M @ 150 (6)                 | 15 M @ 300 (12)     | 15 M @ 450 (18)      | 15 M @ 600 (24)      |
|                          | 2.44 (8.0)                   | 15 M @ 150 (6)                    | 15 M @ 300 (12)     | 15 M @ 450 (18)      | 15 M @ 450 (18)      | 15 M @ 150 (6)                 | 15 M @ 300 (12)     | 15 M @ 450 (18)      | 15 M @ 450 (18)      |
| 3.35<br>(11.0)           | 1.22 (4.0)                   | 15 M @ 600 (24)                   | 10 M @ 450 (18)     | 10 M @ 450 (18)      | 10 M @ 450 (18)      | 15 M @ 600 (24)                | 10 M @ 450 (18)     | 10 M @ 450 (18)      | 10 M @ 450 (18)      |
|                          | 1.53 (5.0)                   | 15 M @ 450 (18)                   | 15 M @ 600 (24)     | 10 M @ 450 (18)      | 10 M @ 450 (18)      | 15 M @ 450 (18)                | 15 M @ 600 (24)     | 10 M @ 450 (18)      | 10 M @ 450 (18)      |
|                          | 1.83 (6.0)                   | 15 M @ 300 (12)                   | 15 M @ 450 (18)     | 15 M @ 600 (24)      | 15 M @ 600 (24)      | 15 M @ 300 (12)                | 15 M @ 450 (18)     | 15 M @ 600 (24)      | 15 M @ 600 (24)      |
|                          | 2.13 (7.0)                   | 15 M @ 150 (6)                    | 15 M @ 450 (18)     | 15 M @ 450 (18)      | 15 M @ 600 (24)      | 15 M @ 150 (6)                 | 15 M @ 300 (12)     | 15 M @ 450 (18)      | 15 M @ 450 (18)      |
|                          | 2.44 (8.0)                   | 15 M @ 150 (6)                    | 15 M @ 300 (12)     | 15 M @ 450 (18)      | 15 M @ 450 (18)      | 15 M @ 150 (6)                 | 15 M @ 300 (12)     | 15 M @ 300 (12)      | 15 M @ 450 (18)      |
| 3.66<br>(12.0)           | 1.22 (4.0)                   | 15 M @ 600 (24)                   | 10 M @ 450 (18)     | 10 M @ 450 (18)      | 10 M @ 450 (18)      | 15 M @ 600 (24)                | 15 M @ 600 (24)     | 10 M @ 450 (18)      | 10 M @ 450 (18)      |
|                          | 1.53 (5.0)                   | 15 M @ 450 (18)                   | 15 M @ 600 (24)     | 10 M @ 450 (18)      | 10 M @ 450 (18)      | 15 M @ 450 (18)                | 15 M @ 600 (24)     | 15 M @ 600 (24)      | 10 M @ 450 (18)      |
|                          | 1.83 (6.0)                   | 15 M @ 300 (12)                   | 15 M @ 450 (18)     | 15 M @ 600 (24)      | 15 M @ 600 (24)      | 15 M @ 300 (12)                | 15 M @ 450 (18)     | 15 M @ 450 (18)      | 15 M @ 600 (24)      |
|                          | 2.13 (7.0)                   | 15 M @ 150 (6)                    | 15 M @ 300 (12)     | 15 M @ 450 (18)      | 15 M @ 600 (24)      | 15 M @ 150 (6)                 | 15 M @ 300 (12)     | 15 M @ 450 (18)      | 15 M @ 450 (18)      |
|                          | 2.44 (8.0)                   | 15 M @ 150 (6)                    | 15 M @ 300 (12)     | 15 M @ 300 (12)      | 15 M @ 450 (18)      | 15 M @ 150 (6)                 | 15 M @ 300 (12)     | 15 M @ 450 (18)      | 15 M @ 450 (18)      |
| Horizontal Reinforcement | Block Height of 12" and 18"  | 10 M @ 450 (18)                   | 10 M @ 450 (18)     | 10 M @ 450 (18)      | 10 M @ 450 (18)      | 10 M @ 450 (18)                | 10 M @ 450 (18)     | 10 M @ 450 (18)      | 10 M @ 450 (18)      |
|                          | Block Height of 16"          | 10 M @ 400 (16)                   | 10 M @ 400 (16)     | 10 M @ 400 (16)      | 10 M @ 400 (16)      | 10 M @ 400 (16)                | 10 M @ 400 (16)     | 10 M @ 400 (16)      | 10 M @ 400 (16)      |

**NOTES:**

- For highlighted data, where the below grade wall meets all the requirements of NBCC Part 9 for a solid concrete foundation wall and supports only wood frame construction above, a 20MPa unreinforced wall is adequate as per 2020 NBCC table 9.15.4.2.A. Provide the reinforcing shown for walls supporting ICF walls above or with brick veneer supported with the brick ledge form.
- Below grade walls supporting "Drained Earth" in accordance with 2020 NBCC 9.4.4.6 may be designed for an equivalent fluid pressure of 480 kg/m<sup>3</sup>.
- This table is to be used in conjunction with the "Design Limitations" and "Below Grade Reinforcement Placement" drawing.
- Alternating horizontal bar spacing of 12" o.c. and 24" o.c. may be used to achieve an average spacing of 18" o.c. where 18" o.c. spacing is specified for horizontal bars, as shown in Detail A.3.

INSULATING CONCRETE FORMS MANUFACTURERS ASSOCIATION



**Table B.2.1. Continued – Below Grade Wall Distributed Reinforcement for Seismic Zone Classification,  $0.11 < S_{a,ICF} \leq 0.16$  and Hourly Wind Pressure,  $q_{1/50} \leq 1.05\text{kPa}$ , for ICF Walls with 6” Tie Spacing**

| Wall Height<br>m<br>(ft) | Backfill Height<br>m<br>(ft) | Vertical Steel (Size and Spacing) |                     |                      |                      |                                 |                     |                      |                      |
|--------------------------|------------------------------|-----------------------------------|---------------------|----------------------|----------------------|---------------------------------|---------------------|----------------------|----------------------|
|                          |                              | Backfill Equivalent Fluid Density |                     |                      |                      |                                 |                     |                      |                      |
|                          |                              | 960 kg/m <sup>3</sup> (60 pcf)    |                     |                      |                      | 1200 kg/m <sup>3</sup> (75 pcf) |                     |                      |                      |
|                          |                              | 150 mm (6")<br>25MPa Wall         | 200 mm (8")<br>Wall | 250 mm (10")<br>Wall | 300 mm (12")<br>Wall | 150 mm (6")<br>25MPa Wall       | 200 mm (8")<br>Wall | 250 mm (10")<br>Wall | 300 mm (12")<br>Wall |
| 2.44<br>(8.0)            | 1.22 (4.0)                   | 15 M @ 450 (18)                   | 10 M @ 450 (18)     | 10 M @ 450 (18)      | 10 M @ 450 (18)      | 15 M @ 450 (18)                 | 10 M @ 450 (18)     | 10 M @ 450 (18)      | 10 M @ 450 (18)      |
|                          | 1.53 (5.0)                   | 15 M @ 450 (18)                   | 15 M @ 600 (24)     | 10 M @ 450 (18)      | 10 M @ 450 (18)      | 15 M @ 450 (18)                 | 15 M @ 600 (24)     | 10 M @ 450 (18)      | 10 M @ 450 (18)      |
|                          | 1.83 (6.0)                   | 15 M @ 300 (12)                   | 15 M @ 450 (18)     | 15 M @ 600 (24)      | 10 M @ 450 (18)      | 15 M @ 300 (12)                 | 15 M @ 450 (18)     | 15 M @ 600 (24)      | 15 M @ 600 (24)      |
|                          | 2.13 (7.0)                   | 15 M @ 300 (12)                   | 15 M @ 450 (18)     | 15 M @ 450 (18)      | 15 M @ 600 (24)      | 15 M @ 150 (6)                  | 15 M @ 300 (12)     | 15 M @ 450 (18)      | 15 M @ 600 (24)      |
|                          | 2.44 (8.0)                   | 15 M @ 150 (6)                    | 15 M @ 300 (12)     | 15 M @ 450 (18)      | 15 M @ 600 (24)      | 15 M @ 150 (6)                  | 15 M @ 300 (12)     | 15 M @ 450 (18)      | 15 M @ 450 (18)      |
| 2.74<br>(9.0)            | 1.22 (4.0)                   | 15 M @ 600 (24)                   | 15 M @ 600 (24)     | 10 M @ 450 (18)      | 10 M @ 450 (18)      | 15 M @ 600 (24)                 | 15 M @ 600 (24)     | 10 M @ 450 (18)      | 10 M @ 450 (18)      |
|                          | 1.53 (5.0)                   | 15 M @ 450 (18)                   | 15 M @ 600 (24)     | 10 M @ 450 (18)      | 10 M @ 450 (18)      | 15 M @ 450 (18)                 | 15 M @ 600 (24)     | 10 M @ 450 (18)      | 10 M @ 450 (18)      |
|                          | 1.83 (6.0)                   | 15 M @ 300 (12)                   | 15 M @ 450 (18)     | 15 M @ 600 (24)      | 15 M @ 600 (24)      | 15 M @ 300 (12)                 | 15 M @ 450 (18)     | 15 M @ 450 (18)      | 15 M @ 600 (24)      |
|                          | 2.13 (7.0)                   | 15 M @ 150 (6)                    | 15 M @ 300 (12)     | 15 M @ 450 (18)      | 15 M @ 600 (24)      | 15 M @ 150 (6)                  | 15 M @ 300 (12)     | 15 M @ 450 (18)      | 15 M @ 450 (18)      |
|                          | 2.44 (8.0)                   | 15 M @ 150 (6)                    | 15 M @ 300 (12)     | 15 M @ 450 (18)      | 15 M @ 450 (18)      | 15 M @ 150 (6)                  | 15 M @ 300 (12)     | 15 M @ 300 (12)      | 15 M @ 300 (12)      |
| 2.74 (9.0)               | 15 M @ 150 (6)               | 15 M @ 300 (12)                   | 15 M @ 300 (12)     | 15 M @ 300 (12)      | 15 M @ 150 (6)       | 15 M @ 150 (6)                  | 15 M @ 300 (12)     | 15 M @ 300 (12)      |                      |
| 3.05<br>(10.0)           | 1.22 (4.0)                   | 15 M @ 600 (24)                   | 15 M @ 600 (24)     | 10 M @ 450 (18)      | 10 M @ 450 (18)      | 15 M @ 600 (24)                 | 15 M @ 600 (24)     | 10 M @ 450 (18)      | 10 M @ 450 (18)      |
|                          | 1.53 (5.0)                   | 15 M @ 450 (18)                   | 15 M @ 600 (24)     | 10 M @ 450 (18)      | 10 M @ 450 (18)      | 15 M @ 450 (18)                 | 15 M @ 600 (24)     | 15 M @ 600 (24)      | 10 M @ 450 (18)      |
|                          | 1.83 (6.0)                   | 15 M @ 300 (12)                   | 15 M @ 450 (18)     | 15 M @ 600 (24)      | 15 M @ 600 (24)      | 15 M @ 300 (12)                 | 15 M @ 450 (18)     | 15 M @ 450 (18)      | 15 M @ 600 (24)      |
|                          | 2.13 (7.0)                   | 15 M @ 150 (6)                    | 15 M @ 300 (12)     | 15 M @ 450 (18)      | 15 M @ 450 (18)      | 15 M @ 150 (6)                  | 15 M @ 300 (12)     | 15 M @ 450 (18)      | 15 M @ 450 (18)      |
|                          | 2.44 (8.0)                   | 15 M @ 150 (6)                    | 15 M @ 300 (12)     | 15 M @ 300 (12)      | 15 M @ 300 (12)      | 15 M @ 150 (6)                  | 15 M @ 150 (6)      | 15 M @ 300 (12)      | 15 M @ 300 (12)      |
| 2.74 (9.0)               |                              | 15 M @ 150 (6)                    | 15 M @ 300 (12)     | 15 M @ 300 (12)      |                      | 15 M @ 150 (6)                  | 15 M @ 300 (12)     | 15 M @ 300 (12)      |                      |
| 3.05 (10.0)              |                              | 15 M @ 150 (6)                    | 15 M @ 150 (6)      | 15 M @ 150 (6)       | 15 M @ 300 (12)      |                                 | 15 M @ 150 (6)      | 15 M @ 300 (12)      |                      |
| 3.35<br>(11.0)           | 1.22 (4.0)                   | 15 M @ 600 (24)                   | 15 M @ 600 (24)     | 10 M @ 450 (18)      | 10 M @ 450 (18)      | 15 M @ 600 (24)                 | 15 M @ 600 (24)     | 10 M @ 450 (18)      | 10 M @ 450 (18)      |
|                          | 1.53 (5.0)                   | 15 M @ 450 (18)                   | 15 M @ 600 (24)     | 10 M @ 450 (18)      | 10 M @ 450 (18)      | 15 M @ 450 (18)                 | 15 M @ 600 (24)     | 15 M @ 600 (24)      | 10 M @ 450 (18)      |
|                          | 1.83 (6.0)                   | 15 M @ 300 (12)                   | 15 M @ 450 (18)     | 15 M @ 450 (18)      | 15 M @ 600 (24)      | 15 M @ 150 (6)                  | 15 M @ 450 (18)     | 15 M @ 600 (24)      | 15 M @ 600 (24)      |
|                          | 2.13 (7.0)                   | 15 M @ 150 (6)                    | 15 M @ 300 (12)     | 15 M @ 450 (18)      | 15 M @ 450 (18)      | 15 M @ 150 (6)                  | 15 M @ 300 (12)     | 15 M @ 450 (18)      | 15 M @ 450 (18)      |
|                          | 2.44 (8.0)                   | 15 M @ 150 (6)                    | 15 M @ 150 (6)      | 15 M @ 300 (12)      | 15 M @ 300 (12)      |                                 | 15 M @ 150 (6)      | 15 M @ 300 (12)      | 15 M @ 300 (12)      |
| 2.74 (9.0)               |                              | 15 M @ 150 (6)                    | 15 M @ 300 (12)     | 15 M @ 300 (12)      |                      | 15 M @ 150 (6)                  | 15 M @ 150 (6)      | 15 M @ 300 (12)      |                      |
| 3.05 (10.0)              |                              | 15 M @ 150 (6)                    | 15 M @ 150 (6)      | 15 M @ 150 (6)       | 15 M @ 300 (12)      |                                 | 15 M @ 150 (6)      | 15 M @ 300 (12)      |                      |
| 3.35 (11.0)              |                              |                                   | 15 M @ 150 (6)      | 15 M @ 150 (6)       | 15 M @ 150 (6)       |                                 | 15 M @ 150 (6)      | 15 M @ 150 (6)       |                      |
| 3.66<br>(12.0)           | 1.22 (4.0)                   | 15 M @ 600 (24)                   | 15 M @ 600 (24)     | 10 M @ 450 (18)      | 10 M @ 450 (18)      | 15 M @ 450 (18)                 | 15 M @ 600 (24)     | 10 M @ 450 (18)      | 10 M @ 450 (18)      |
|                          | 1.53 (5.0)                   | 15 M @ 450 (18)                   | 15 M @ 600 (24)     | 15 M @ 600 (24)      | 10 M @ 450 (18)      | 15 M @ 450 (18)                 | 15 M @ 450 (18)     | 15 M @ 600 (24)      | 10 M @ 450 (18)      |
|                          | 1.83 (6.0)                   | 15 M @ 150 (6)                    | 15 M @ 450 (18)     | 15 M @ 450 (18)      | 15 M @ 600 (24)      | 15 M @ 150 (6)                  | 15 M @ 300 (12)     | 15 M @ 450 (18)      | 15 M @ 600 (24)      |
|                          | 2.13 (7.0)                   | 15 M @ 150 (6)                    | 15 M @ 300 (12)     | 15 M @ 450 (18)      | 15 M @ 450 (18)      | 15 M @ 150 (6)                  | 15 M @ 300 (12)     | 15 M @ 300 (12)      | 15 M @ 450 (18)      |
|                          | 2.44 (8.0)                   |                                   | 15 M @ 150 (6)      | 15 M @ 300 (12)      | 15 M @ 300 (12)      |                                 | 15 M @ 150 (6)      | 15 M @ 300 (12)      | 15 M @ 300 (12)      |
| 2.74 (9.0)               |                              | 15 M @ 150 (6)                    | 15 M @ 150 (6)      | 15 M @ 300 (12)      |                      | 15 M @ 150 (6)                  | 15 M @ 150 (6)      | 15 M @ 300 (12)      |                      |
| 3.05 (10.0)              |                              |                                   | 15 M @ 150 (6)      | 15 M @ 150 (6)       |                      |                                 | 15 M @ 150 (6)      | 15 M @ 150 (6)       |                      |
| 3.35 (11.0)              |                              |                                   | 15 M @ 150 (6)      | 15 M @ 150 (6)       | 15 M @ 150 (6)       |                                 | 15 M @ 150 (6)      | 15 M @ 150 (6)       |                      |
| 3.66 (12.0)              |                              |                                   | 15 M @ 150 (6)      | 15 M @ 150 (6)       | 15 M @ 150 (6)       |                                 | 15 M @ 150 (6)      | 15 M @ 150 (6)       |                      |
| Horizontal Reinforcement | Block Height of 12" and 18"  | 10 M @ 450 (18)                   | 10 M @ 450 (18)     | 10 M @ 450 (18)      | 10 M @ 450 (18)      | 10 M @ 450 (18)                 | 10 M @ 450 (18)     | 10 M @ 450 (18)      | 10 M @ 450 (18)      |
|                          | Block Height of 16"          | 10 M @ 400 (16)                   | 10 M @ 400 (16)     | 10 M @ 400 (16)      | 10 M @ 400 (16)      | 10 M @ 400 (16)                 | 10 M @ 400 (16)     | 10 M @ 400 (16)      | 10 M @ 400 (16)      |

**NOTES:**

- For highlighted data, where the below grade wall meets all the requirements of NBCC Part 9 for a solid concrete foundation wall and supports only wood frame construction above, a 20MPa unreinforced wall is adequate as per 2020 NBCC table 9.15.4.2.A. Provide the reinforcing shown for walls supporting ICF walls above or with brick veneer supported with the brick ledge form.
- Below grade walls supporting "Drained Earth" in accordance with 2020 NBCC 9.4.4.6 may be designed for an equivalent fluid pressure of 480 kg/m<sup>3</sup>.
- This table is to be used in conjunction with the "Design Limitations" and "Below Grade Reinforcement Placement" drawing.
- Alternating horizontal bar spacing of 12" o.c. and 24" o.c. may be used to achieve an average spacing of 18" o.c. where 18" o.c. spacing is specified for horizontal bars, as shown in Detail A.3.



**Table B.2.2. – Below Grade Wall Distributed Reinforcement for Seismic Zone Classification,  $0.11 < S_{a,ICF} \leq 0.16$  and Hourly Wind Pressure,  $q_{1/50} \leq 1.05\text{kPa}$ , for ICF Walls with 8" Tie Spacing**

| Wall Height<br>m<br>(ft) | Backfill Height<br>m<br>(ft) | Vertical Steel (Size and Spacing) |                     |                      |                      |                                |                     |                      |                      |
|--------------------------|------------------------------|-----------------------------------|---------------------|----------------------|----------------------|--------------------------------|---------------------|----------------------|----------------------|
|                          |                              | 480 kg/m <sup>3</sup> (30 pcf)    |                     |                      |                      | 720 kg/m <sup>3</sup> (45 pcf) |                     |                      |                      |
|                          |                              | 150 mm (6")<br>25MPa Wall         | 200 mm (8")<br>Wall | 250 mm (10")<br>Wall | 300 mm (12")<br>Wall | 150 mm (6")<br>25MPa Wall      | 200 mm (8")<br>Wall | 250 mm (10")<br>Wall | 300 mm (12")<br>Wall |
| 2.44<br>(8.0)            | 1.22 (4.0)                   | 10 M @ 400 (16)                   | 10 M @ 600 (24)     | 10 M @ 400 (16)      | 10 M @ 400 (16)      | 15 M @ 400 (16)                | 10 M @ 400 (16)     | 10 M @ 400 (16)      | 10 M @ 400 (16)      |
|                          | 1.53 (5.0)                   | 15 M @ 600 (24)                   | 15 M @ 600 (24)     | 10 M @ 400 (16)      | 10 M @ 400 (16)      | 15 M @ 400 (16)                | 15 M @ 600 (24)     | 10 M @ 400 (16)      | 10 M @ 400 (16)      |
|                          | 1.83 (6.0)                   | 15 M @ 400 (16)                   | 15 M @ 600 (24)     | 15 M @ 600 (24)      | 15 M @ 600 (24)      | 15 M @ 400 (16)                | 15 M @ 400 (16)     | 15 M @ 600 (24)      | 15 M @ 600 (24)      |
|                          | 2.13 (7.0)                   | 15 M @ 400 (16)                   | 15 M @ 400 (16)     | 15 M @ 600 (24)      | 15 M @ 600 (24)      | 15 M @ 200 (8)                 | 15 M @ 400 (16)     | 15 M @ 400 (16)      | 15 M @ 600 (24)      |
|                          | 2.44 (8.0)                   | 15 M @ 200 (8)                    | 15 M @ 400 (16)     | 15 M @ 600 (24)      | 15 M @ 600 (24)      | 15 M @ 200 (8)                 | 15 M @ 400 (16)     | 15 M @ 400 (16)      | 15 M @ 600 (24)      |
| 2.74<br>(9.0)            | 1.22 (4.0)                   | 15 M @ 600 (24)                   | 10 M @ 400 (16)     | 10 M @ 400 (16)      | 10 M @ 400 (16)      | 15 M @ 600 (24)                | 10 M @ 400 (16)     | 10 M @ 400 (16)      | 10 M @ 400 (16)      |
|                          | 1.53 (5.0)                   | 15 M @ 400 (16)                   | 15 M @ 600 (24)     | 10 M @ 400 (16)      | 10 M @ 400 (16)      | 15 M @ 400 (16)                | 15 M @ 600 (24)     | 15 M @ 600 (24)      | 10 M @ 400 (16)      |
|                          | 1.83 (6.0)                   | 15 M @ 400 (16)                   | 15 M @ 600 (24)     | 15 M @ 600 (24)      | 15 M @ 600 (24)      | 15 M @ 400 (16)                | 15 M @ 400 (16)     | 15 M @ 600 (24)      | 15 M @ 600 (24)      |
|                          | 2.13 (7.0)                   | 15 M @ 200 (8)                    | 15 M @ 400 (16)     | 15 M @ 600 (24)      | 15 M @ 600 (24)      | 15 M @ 200 (8)                 | 15 M @ 400 (16)     | 15 M @ 400 (16)      | 15 M @ 600 (24)      |
|                          | 2.44 (8.0)                   | 15 M @ 200 (8)                    | 15 M @ 400 (16)     | 15 M @ 400 (16)      | 15 M @ 400 (16)      | 15 M @ 200 (8)                 | 15 M @ 400 (16)     | 15 M @ 400 (16)      | 15 M @ 600 (24)      |
|                          | 2.74 (9.0)                   | 15 M @ 200 (8)                    | 15 M @ 400 (16)     | 15 M @ 400 (16)      | 15 M @ 400 (16)      | 15 M @ 200 (8)                 | 15 M @ 400 (16)     | 15 M @ 400 (16)      | 15 M @ 600 (24)      |
| 3.05<br>(10.0)           | 1.22 (4.0)                   | 15 M @ 600 (24)                   | 10 M @ 400 (16)     | 10 M @ 400 (16)      | 10 M @ 400 (16)      | 15 M @ 600 (24)                | 10 M @ 400 (16)     | 10 M @ 400 (16)      | 10 M @ 400 (16)      |
|                          | 1.53 (5.0)                   | 15 M @ 400 (16)                   | 15 M @ 600 (24)     | 10 M @ 400 (16)      | 10 M @ 400 (16)      | 15 M @ 400 (16)                | 15 M @ 600 (24)     | 10 M @ 400 (16)      | 10 M @ 400 (16)      |
|                          | 1.83 (6.0)                   | 15 M @ 400 (16)                   | 15 M @ 400 (16)     | 15 M @ 600 (24)      | 15 M @ 600 (24)      | 15 M @ 200 (8)                 | 15 M @ 400 (16)     | 15 M @ 600 (24)      | 15 M @ 600 (24)      |
|                          | 2.13 (7.0)                   | 15 M @ 200 (8)                    | 15 M @ 400 (16)     | 15 M @ 400 (16)      | 15 M @ 600 (24)      | 15 M @ 200 (8)                 | 15 M @ 400 (16)     | 15 M @ 400 (16)      | 15 M @ 600 (24)      |
|                          | 2.44 (8.0)                   | 15 M @ 200 (8)                    | 15 M @ 400 (16)     | 15 M @ 400 (16)      | 15 M @ 400 (16)      | 15 M @ 200 (8)                 | 15 M @ 200 (8)      | 15 M @ 400 (16)      | 15 M @ 400 (16)      |
|                          | 2.74 (9.0)                   | 15 M @ 200 (8)                    | 15 M @ 200 (8)      | 15 M @ 400 (16)      | 15 M @ 400 (16)      | 15 M @ 200 (8)                 | 15 M @ 200 (8)      | 15 M @ 400 (16)      | 15 M @ 400 (16)      |
| 3.35<br>(11.0)           | 1.22 (4.0)                   | 15 M @ 600 (24)                   | 10 M @ 400 (16)     | 10 M @ 400 (16)      | 10 M @ 400 (16)      | 15 M @ 600 (24)                | 10 M @ 400 (16)     | 10 M @ 400 (16)      | 10 M @ 400 (16)      |
|                          | 1.53 (5.0)                   | 15 M @ 400 (16)                   | 15 M @ 600 (24)     | 10 M @ 400 (16)      | 10 M @ 400 (16)      | 15 M @ 400 (16)                | 15 M @ 600 (24)     | 10 M @ 400 (16)      | 10 M @ 400 (16)      |
|                          | 1.83 (6.0)                   | 15 M @ 200 (8)                    | 15 M @ 400 (16)     | 15 M @ 600 (24)      | 15 M @ 600 (24)      | 15 M @ 200 (8)                 | 15 M @ 400 (16)     | 15 M @ 600 (24)      | 15 M @ 600 (24)      |
|                          | 2.13 (7.0)                   | 15 M @ 200 (8)                    | 15 M @ 400 (16)     | 15 M @ 400 (16)      | 15 M @ 600 (24)      | 15 M @ 200 (8)                 | 15 M @ 400 (16)     | 15 M @ 400 (16)      | 15 M @ 400 (16)      |
|                          | 2.44 (8.0)                   | 15 M @ 200 (8)                    | 15 M @ 200 (8)      | 15 M @ 400 (16)      | 15 M @ 400 (16)      | 15 M @ 200 (8)                 | 15 M @ 200 (8)      | 15 M @ 400 (16)      | 15 M @ 400 (16)      |
|                          | 2.74 (9.0)                   | 15 M @ 200 (8)                    | 15 M @ 200 (8)      | 15 M @ 200 (8)       | 15 M @ 400 (16)      | 15 M @ 200 (8)                 | 15 M @ 200 (8)      | 15 M @ 400 (16)      | 15 M @ 400 (16)      |
| 3.66<br>(12.0)           | 1.22 (4.0)                   | 15 M @ 600 (24)                   | 10 M @ 400 (16)     | 10 M @ 400 (16)      | 10 M @ 400 (16)      | 15 M @ 600 (24)                | 15 M @ 600 (24)     | 10 M @ 400 (16)      | 10 M @ 400 (16)      |
|                          | 1.53 (5.0)                   | 15 M @ 400 (16)                   | 15 M @ 600 (24)     | 10 M @ 400 (16)      | 10 M @ 400 (16)      | 15 M @ 400 (16)                | 15 M @ 600 (24)     | 15 M @ 600 (24)      | 10 M @ 400 (16)      |
|                          | 1.83 (6.0)                   | 15 M @ 200 (8)                    | 15 M @ 400 (16)     | 15 M @ 600 (24)      | 15 M @ 600 (24)      | 15 M @ 200 (8)                 | 15 M @ 400 (16)     | 15 M @ 400 (16)      | 15 M @ 600 (24)      |
|                          | 2.13 (7.0)                   | 15 M @ 200 (8)                    | 15 M @ 400 (16)     | 15 M @ 400 (16)      | 15 M @ 600 (24)      | 15 M @ 200 (8)                 | 15 M @ 200 (8)      | 15 M @ 400 (16)      | 15 M @ 400 (16)      |
|                          | 2.44 (8.0)                   | 15 M @ 200 (8)                    | 15 M @ 200 (8)      | 15 M @ 400 (16)      | 15 M @ 400 (16)      | 15 M @ 200 (8)                 | 15 M @ 200 (8)      | 15 M @ 400 (16)      | 15 M @ 400 (16)      |
|                          | 2.74 (9.0)                   | 15 M @ 200 (8)                    | 15 M @ 200 (8)      | 15 M @ 200 (8)       | 15 M @ 400 (16)      | 15 M @ 200 (8)                 | 15 M @ 200 (8)      | 15 M @ 200 (8)       | 15 M @ 400 (16)      |
| Horizontal Reinforcement | Block height of 12" and 18"  | 10 M @ 450 (18)                   | 10 M @ 450 (18)     | 10 M @ 450 (18)      | 10 M @ 450 (18)      | 10 M @ 450 (18)                | 10 M @ 450 (18)     | 10 M @ 450 (18)      | 10 M @ 450 (18)      |
|                          | Block Height of 16"          | 10 M @ 400 (16)                   | 10 M @ 400 (16)     | 10 M @ 400 (16)      | 10 M @ 400 (16)      | 10 M @ 400 (16)                | 10 M @ 400 (16)     | 10 M @ 400 (16)      | 10 M @ 400 (16)      |

**NOTES:**

- For highlighted data, where the below grade wall meets all the requirements of NBCC Part 9 for a solid concrete foundation wall and supports only wood frame construction above, a 20MPa unreinforced wall is adequate as per 2020 NBCC table 9.15.4.2.A. Provide the reinforcing shown for walls supporting ICF walls above or with brick veneer supported with the brick ledge form.
- Below grade walls supporting "Drained Earth" in accordance with 2020 NBCC 9.4.4.6 may be designed for an equivalent fluid pressure of 480 kg/m<sup>3</sup>.
- This table is to be used in conjunction with the "Design Limitations" and "Below Grade Reinforcement Placement" drawing.
- Alternating horizontal bar spacing of 12" o.c. and 24" o.c. may be used to achieve an average spacing of 18" o.c. where 18" o.c. spacing is specified for horizontal bars, as shown in Detail A.3.



**Table B.2.2. Continued – Below Grade Wall Distributed Reinforcement for Seismic Zone Classification,  $0.11 < S_{a,ICF} \leq 0.16$  and Hourly Wind Pressure,  $q_{1/50} \leq 1.05kPa$ , for ICF Walls with 8” Tie Spacing**

| Wall Height<br>m<br>(ft) | Backfill Height<br>m<br>(ft) | Vertical Steel (Size and Spacing) |                     |                      |                      |                                 |                     |                      |                      |
|--------------------------|------------------------------|-----------------------------------|---------------------|----------------------|----------------------|---------------------------------|---------------------|----------------------|----------------------|
|                          |                              | Backfill Equivalent Fluid Density |                     |                      |                      |                                 |                     |                      |                      |
|                          |                              | 960 kg/m <sup>3</sup> (60 pcf)    |                     |                      |                      | 1200 kg/m <sup>3</sup> (75 pcf) |                     |                      |                      |
|                          |                              | 150 mm (6")<br>25MPa Wall         | 200 mm (8")<br>Wall | 250 mm (10")<br>Wall | 300 mm (12")<br>Wall | 150 mm (6")<br>25MPa Wall       | 200 mm (8")<br>Wall | 250 mm (10")<br>Wall | 300 mm (12")<br>Wall |
| 2.44<br>(8.0)            | 1.22 (4.0)                   | 15 M @ 400 (16)                   | 10 M @ 400 (16)     | 10 M @ 400 (16)      | 10 M @ 400 (16)      | 15 M @ 400 (16)                 | 10 M @ 400 (16)     | 10 M @ 400 (16)      | 10 M @ 400 (16)      |
|                          | 1.53 (5.0)                   | 15 M @ 400 (16)                   | 15 M @ 600 (24)     | 10 M @ 400 (16)      | 10 M @ 400 (16)      | 15 M @ 400 (16)                 | 15 M @ 600 (24)     | 10 M @ 400 (16)      | 10 M @ 400 (16)      |
|                          | 1.83 (6.0)                   | 15 M @ 400 (16)                   | 15 M @ 400 (16)     | 15 M @ 600 (24)      | 10 M @ 400 (16)      | 15 M @ 200 (8)                  | 15 M @ 400 (16)     | 15 M @ 600 (24)      | 15 M @ 600 (24)      |
|                          | 2.13 (7.0)                   | 15 M @ 200 (8)                    | 15 M @ 400 (16)     | 15 M @ 400 (16)      | 15 M @ 600 (24)      | 15 M @ 200 (8)                  | 15 M @ 400 (16)     | 15 M @ 400 (16)      | 15 M @ 600 (24)      |
|                          | 2.44 (8.0)                   | 15 M @ 200 (8)                    | 15 M @ 400 (16)     | 15 M @ 400 (16)      | 15 M @ 600 (24)      | 15 M @ 200 (8)                  | 15 M @ 200 (8)      | 15 M @ 400 (16)      | 15 M @ 400 (16)      |
| 2.74<br>(9.0)            | 1.22 (4.0)                   | 15 M @ 600 (24)                   | 15 M @ 600 (24)     | 10 M @ 400 (16)      | 10 M @ 400 (16)      | 15 M @ 600 (24)                 | 15 M @ 600 (24)     | 10 M @ 400 (16)      | 10 M @ 400 (16)      |
|                          | 1.53 (5.0)                   | 15 M @ 400 (16)                   | 15 M @ 600 (24)     | 10 M @ 400 (16)      | 10 M @ 400 (16)      | 15 M @ 400 (16)                 | 15 M @ 600 (24)     | 10 M @ 400 (16)      | 10 M @ 400 (16)      |
|                          | 1.83 (6.0)                   | 15 M @ 200 (8)                    | 15 M @ 400 (16)     | 15 M @ 600 (24)      | 15 M @ 600 (24)      | 15 M @ 200 (8)                  | 15 M @ 400 (16)     | 15 M @ 400 (16)      | 15 M @ 600 (24)      |
|                          | 2.13 (7.0)                   | 15 M @ 200 (8)                    | 15 M @ 400 (16)     | 15 M @ 400 (16)      | 15 M @ 600 (24)      | 15 M @ 200 (8)                  | 15 M @ 400 (16)     | 15 M @ 400 (16)      | 15 M @ 400 (16)      |
|                          | 2.44 (8.0)                   | 15 M @ 200 (8)                    | 15 M @ 200 (8)      | 15 M @ 400 (16)      | 15 M @ 400 (16)      | 15 M @ 200 (8)                  | 15 M @ 200 (8)      | 15 M @ 400 (16)      | 15 M @ 400 (16)      |
|                          | 2.74 (9.0)                   | 15 M @ 200 (8)                    | 15 M @ 200 (8)      | 15 M @ 400 (16)      | 15 M @ 400 (16)      | 15 M @ 200 (8)                  | 15 M @ 200 (8)      | 15 M @ 200 (8)       | 15 M @ 200 (8)       |
| 3.05<br>(10.0)           | 1.22 (4.0)                   | 15 M @ 600 (24)                   | 15 M @ 600 (24)     | 10 M @ 400 (16)      | 10 M @ 400 (16)      | 15 M @ 600 (24)                 | 15 M @ 600 (24)     | 10 M @ 400 (16)      | 10 M @ 400 (16)      |
|                          | 1.53 (5.0)                   | 15 M @ 400 (16)                   | 15 M @ 600 (24)     | 10 M @ 400 (16)      | 10 M @ 400 (16)      | 15 M @ 400 (16)                 | 15 M @ 600 (24)     | 15 M @ 600 (24)      | 10 M @ 400 (16)      |
|                          | 1.83 (6.0)                   | 15 M @ 200 (8)                    | 15 M @ 400 (16)     | 15 M @ 600 (24)      | 15 M @ 600 (24)      | 15 M @ 200 (8)                  | 15 M @ 400 (16)     | 15 M @ 400 (16)      | 15 M @ 600 (24)      |
|                          | 2.13 (7.0)                   | 15 M @ 200 (8)                    | 15 M @ 400 (16)     | 15 M @ 400 (16)      | 15 M @ 400 (16)      | 15 M @ 200 (8)                  | 15 M @ 200 (8)      | 15 M @ 400 (16)      | 15 M @ 400 (16)      |
|                          | 2.44 (8.0)                   |                                   | 15 M @ 200 (8)      | 15 M @ 400 (16)      | 15 M @ 400 (16)      |                                 | 15 M @ 200 (8)      | 15 M @ 200 (8)       | 15 M @ 400 (16)      |
|                          | 2.74 (9.0)                   |                                   | 15 M @ 200 (8)      | 15 M @ 200 (8)       | 15 M @ 200 (8)       |                                 | 15 M @ 200 (8)      | 15 M @ 200 (8)       | 15 M @ 200 (8)       |
|                          | 3.05 (10.0)                  |                                   | 15 M @ 200 (8)      | 15 M @ 200 (8)       | 15 M @ 200 (8)       |                                 | 15 M @ 200 (8)      | 15 M @ 200 (8)       | 15 M @ 200 (8)       |
| 3.35<br>(11.0)           | 1.22 (4.0)                   | 15 M @ 600 (24)                   | 15 M @ 600 (24)     | 10 M @ 400 (16)      | 10 M @ 400 (16)      | 15 M @ 600 (24)                 | 15 M @ 600 (24)     | 10 M @ 400 (16)      | 10 M @ 400 (16)      |
|                          | 1.53 (5.0)                   | 15 M @ 400 (16)                   | 15 M @ 600 (24)     | 10 M @ 400 (16)      | 10 M @ 400 (16)      | 15 M @ 400 (16)                 | 15 M @ 600 (24)     | 15 M @ 600 (24)      | 10 M @ 400 (16)      |
|                          | 1.83 (6.0)                   | 15 M @ 200 (8)                    | 15 M @ 400 (16)     | 15 M @ 600 (24)      | 15 M @ 600 (24)      | 15 M @ 200 (8)                  | 15 M @ 400 (16)     | 15 M @ 400 (16)      | 15 M @ 600 (24)      |
|                          | 2.13 (7.0)                   | 15 M @ 200 (8)                    | 15 M @ 200 (8)      | 15 M @ 400 (16)      | 15 M @ 400 (16)      |                                 | 15 M @ 200 (8)      | 15 M @ 400 (16)      | 15 M @ 400 (16)      |
|                          | 2.44 (8.0)                   |                                   | 15 M @ 200 (8)      | 15 M @ 200 (8)       | 15 M @ 400 (16)      |                                 | 15 M @ 200 (8)      | 15 M @ 200 (8)       | 15 M @ 200 (8)       |
|                          | 2.74 (9.0)                   |                                   | 15 M @ 200 (8)      | 15 M @ 200 (8)       | 15 M @ 200 (8)       |                                 | 15 M @ 200 (8)      | 15 M @ 200 (8)       | 15 M @ 200 (8)       |
|                          | 3.05 (10.0)                  |                                   |                     | 15 M @ 200 (8)       | 15 M @ 200 (8)       |                                 |                     | 15 M @ 200 (8)       | 15 M @ 200 (8)       |
|                          | 3.35 (11.0)                  |                                   |                     | 15 M @ 200 (8)       | 15 M @ 200 (8)       |                                 |                     | 15 M @ 200 (8)       | 15 M @ 200 (8)       |
| 3.66<br>(12.0)           | 1.22 (4.0)                   | 15 M @ 600 (24)                   | 15 M @ 600 (24)     | 10 M @ 400 (16)      | 10 M @ 400 (16)      | 15 M @ 400 (16)                 | 15 M @ 600 (24)     | 10 M @ 400 (16)      | 10 M @ 400 (16)      |
|                          | 1.53 (5.0)                   | 15 M @ 400 (16)                   | 15 M @ 600 (24)     | 15 M @ 600 (24)      | 10 M @ 400 (16)      | 15 M @ 400 (16)                 | 15 M @ 400 (16)     | 15 M @ 600 (24)      | 10 M @ 400 (16)      |
|                          | 1.83 (6.0)                   | 15 M @ 200 (8)                    | 15 M @ 400 (16)     | 15 M @ 400 (16)      | 15 M @ 600 (24)      | 15 M @ 200 (8)                  | 15 M @ 400 (16)     | 15 M @ 400 (16)      | 15 M @ 600 (24)      |
|                          | 2.13 (7.0)                   |                                   | 15 M @ 200 (8)      | 15 M @ 400 (16)      | 15 M @ 400 (16)      |                                 | 15 M @ 200 (8)      | 15 M @ 400 (16)      | 15 M @ 400 (16)      |
|                          | 2.44 (8.0)                   |                                   | 15 M @ 200 (8)      | 15 M @ 200 (8)       | 15 M @ 400 (16)      |                                 | 15 M @ 200 (8)      | 15 M @ 200 (8)       | 15 M @ 200 (8)       |
|                          | 2.74 (9.0)                   |                                   | 15 M @ 200 (8)      | 15 M @ 200 (8)       | 15 M @ 200 (8)       |                                 |                     | 15 M @ 200 (8)       | 15 M @ 200 (8)       |
|                          | 3.05 (10.0)                  |                                   |                     | 15 M @ 200 (8)       | 15 M @ 200 (8)       |                                 |                     | 15 M @ 200 (8)       | 15 M @ 200 (8)       |
|                          | 3.35 (11.0)                  |                                   |                     | 15 M @ 200 (8)       | 15 M @ 200 (8)       |                                 |                     | 15 M @ 200 (8)       | 15 M @ 200 (8)       |
|                          | 3.66 (12.0)                  |                                   |                     | 15 M @ 200 (8)       | 15 M @ 200 (8)       |                                 |                     | 15 M @ 200 (8)       | 15 M @ 200 (8)       |
| Horizontal Reinforcement | Block height of 12" and 18"  | 10 M @ 450 (18)                   | 10 M @ 450 (18)     | 10 M @ 450 (18)      | 10 M @ 450 (18)      | 10 M @ 450 (18)                 | 10 M @ 450 (18)     | 10 M @ 450 (18)      | 10 M @ 450 (18)      |
|                          | Block Height of 16"          | 10 M @ 400 (16)                   | 10 M @ 400 (16)     | 10 M @ 400 (16)      | 10 M @ 400 (16)      | 10 M @ 400 (16)                 | 10 M @ 400 (16)     | 10 M @ 400 (16)      | 10 M @ 400 (16)      |

**NOTES:**

- For highlighted data, where the below grade wall meets all the requirements of NBCC Part 9 for a solid concrete foundation wall and supports only wood frame construction above, a 20MPa unreinforced wall is adequate as per 2020 NBCC table 9.15.4.2.A. Provide the reinforcing shown for walls supporting ICF walls above or with brick veneer supported with the brick ledge form.
- Below grade walls supporting "Drained Earth" in accordance with 2020 NBCC 9.4.4.6 may be designed for an equivalent fluid pressure of 480 kg/m<sup>3</sup>.
- This table is to be used in conjunction with the "Design Limitations" and "Below Grade Reinforcement Placement" drawing.
- Alternating horizontal bar spacing of 12" o.c. and 24" o.c. may be used to achieve an average spacing of 18" o.c. where 18" o.c. spacing is specified for horizontal bars, as shown in Detail A.3.



**Table B.3.1. – Below Grade Wall Distributed Reinforcement for Seismic Zone Classification,  $0.16 < S_{a,ICF} \leq 0.31$  and Hourly Wind Pressure,  $q_{1/50} \leq 1.05\text{kPa}$ , for ICF Walls with 6" Tie Spacing**

| Wall Height<br>m<br>(ft) | Backfill Height<br>m<br>(ft) | Vertical Steel (Size and Spacing) |                     |                      |                      |                                |                     |                      |                      |
|--------------------------|------------------------------|-----------------------------------|---------------------|----------------------|----------------------|--------------------------------|---------------------|----------------------|----------------------|
|                          |                              | Backfill Equivalent Fluid Density |                     |                      |                      |                                |                     |                      |                      |
|                          |                              | 480 kg/m <sup>3</sup> (30 pcf)    |                     |                      |                      | 720 kg/m <sup>3</sup> (45 pcf) |                     |                      |                      |
|                          |                              | 150 mm (6")<br>25MPa Wall         | 200 mm (8")<br>Wall | 250 mm (10")<br>Wall | 300 mm (12")<br>Wall | 150 mm (6")<br>25MPa Wall      | 200 mm (8")<br>Wall | 250 mm (10")<br>Wall | 300 mm (12")<br>Wall |
| 2.44<br>(8.0)            | 1.22 (4.0)                   | 10 M @ 300 (12)                   | 10 M @ 300 (12)     | 10 M @ 300 (12)      | 10 M @ 300 (12)      | 15 M @ 450 (18)                | 10 M @ 300 (12)     | 10 M @ 300 (12)      | 10 M @ 300 (12)      |
|                          | 1.53 (5.0)                   | 15 M @ 450 (18)                   | 10 M @ 300 (12)     | 10 M @ 300 (12)      | 10 M @ 300 (12)      | 15 M @ 450 (18)                | 10 M @ 300 (12)     | 10 M @ 300 (12)      | 10 M @ 300 (12)      |
|                          | 1.83 (6.0)                   | 15 M @ 300 (12)                   | 15 M @ 450 (18)     | 15 M @ 450 (18)      | 10 M @ 300 (12)      | 15 M @ 300 (12)                | 15 M @ 450 (18)     | 15 M @ 450 (18)      | 10 M @ 300 (12)      |
|                          | 2.13 (7.0)                   | 15 M @ 150 (6)                    | 15 M @ 300 (12)     | 15 M @ 450 (18)      | 10 M @ 300 (12)      | 15 M @ 150 (6)                 | 15 M @ 300 (12)     | 15 M @ 450 (18)      | 15 M @ 450 (18)      |
|                          | 2.44 (8.0)                   | 15 M @ 150 (6)                    | 15 M @ 300 (12)     | 15 M @ 450 (18)      | 15 M @ 450 (18)      | 15 M @ 150 (6)                 | 15 M @ 300 (12)     | 15 M @ 300 (12)      | 15 M @ 450 (18)      |
| 2.74<br>(9.0)            | 1.22 (4.0)                   | 10 M @ 300 (12)                   | 10 M @ 300 (12)     | 10 M @ 300 (12)      | 10 M @ 300 (12)      | 10 M @ 300 (12)                | 10 M @ 300 (12)     | 10 M @ 300 (12)      | 10 M @ 300 (12)      |
|                          | 1.53 (5.0)                   | 15 M @ 450 (18)                   | 15 M @ 450 (18)     | 10 M @ 300 (12)      | 10 M @ 300 (12)      | 15 M @ 300 (12)                | 15 M @ 450 (18)     | 10 M @ 300 (12)      | 10 M @ 300 (12)      |
|                          | 1.83 (6.0)                   | 15 M @ 300 (12)                   | 15 M @ 450 (18)     | 15 M @ 450 (18)      | 10 M @ 300 (12)      | 15 M @ 150 (6)                 | 15 M @ 300 (12)     | 15 M @ 450 (18)      | 10 M @ 300 (12)      |
|                          | 2.13 (7.0)                   | 15 M @ 150 (6)                    | 15 M @ 300 (12)     | 15 M @ 450 (18)      | 15 M @ 450 (18)      | 15 M @ 150 (6)                 | 15 M @ 300 (12)     | 15 M @ 450 (18)      | 15 M @ 450 (18)      |
|                          | 2.44 (8.0)                   | 15 M @ 150 (6)                    | 15 M @ 300 (12)     | 15 M @ 300 (12)      | 15 M @ 300 (12)      | 15 M @ 150 (6)                 | 15 M @ 150 (6)      | 15 M @ 300 (12)      | 15 M @ 300 (12)      |
| 2.74 (9.0)               | 15 M @ 150 (6)               | 15 M @ 150 (6)                    | 15 M @ 300 (12)     | 15 M @ 300 (12)      |                      | 15 M @ 150 (6)                 | 15 M @ 300 (12)     | 15 M @ 300 (12)      |                      |
| 3.05<br>(10.0)           | 1.22 (4.0)                   | 10 M @ 300 (12)                   | 10 M @ 300 (12)     | 10 M @ 300 (12)      | 10 M @ 300 (12)      | 10 M @ 300 (12)                | 10 M @ 300 (12)     | 10 M @ 300 (12)      | 10 M @ 300 (12)      |
|                          | 1.53 (5.0)                   | 15 M @ 300 (12)                   | 15 M @ 450 (18)     | 10 M @ 300 (12)      | 10 M @ 300 (12)      | 15 M @ 300 (12)                | 15 M @ 450 (18)     | 10 M @ 300 (12)      | 10 M @ 300 (12)      |
|                          | 1.83 (6.0)                   | 15 M @ 150 (6)                    | 15 M @ 300 (12)     | 15 M @ 450 (18)      | 10 M @ 300 (12)      | 15 M @ 150 (6)                 | 15 M @ 300 (12)     | 15 M @ 450 (18)      | 15 M @ 450 (18)      |
|                          | 2.13 (7.0)                   | 15 M @ 150 (6)                    | 15 M @ 300 (12)     | 15 M @ 450 (18)      | 15 M @ 450 (18)      | 15 M @ 150 (6)                 | 15 M @ 300 (12)     | 15 M @ 450 (18)      | 15 M @ 450 (18)      |
|                          | 2.44 (8.0)                   | 15 M @ 150 (6)                    | 15 M @ 150 (6)      | 15 M @ 300 (12)      | 15 M @ 300 (12)      | 15 M @ 150 (6)                 | 15 M @ 300 (12)     | 15 M @ 450 (18)      | 15 M @ 300 (12)      |
| 2.74 (9.0)               |                              | 15 M @ 150 (6)                    | 15 M @ 150 (6)      | 15 M @ 300 (12)      |                      | 15 M @ 150 (6)                 | 15 M @ 150 (6)      | 15 M @ 300 (12)      |                      |
| 3.05 (10.0)              |                              | 15 M @ 150 (6)                    | 15 M @ 150 (6)      | 15 M @ 300 (12)      |                      | 15 M @ 150 (6)                 | 15 M @ 150 (6)      | 15 M @ 300 (12)      |                      |
| 3.35<br>(11.0)           | 1.22 (4.0)                   | 10 M @ 300 (12)                   | 10 M @ 300 (12)     | 10 M @ 300 (12)      | 10 M @ 300 (12)      | 10 M @ 300 (12)                | 10 M @ 300 (12)     | 10 M @ 300 (12)      | 10 M @ 300 (12)      |
|                          | 1.53 (5.0)                   | 15 M @ 300 (12)                   | 15 M @ 450 (18)     | 10 M @ 300 (12)      | 10 M @ 300 (12)      | 15 M @ 300 (12)                | 15 M @ 450 (18)     | 10 M @ 300 (12)      | 10 M @ 300 (12)      |
|                          | 1.83 (6.0)                   | 15 M @ 150 (6)                    | 15 M @ 300 (12)     | 15 M @ 450 (18)      | 10 M @ 300 (12)      | 15 M @ 150 (6)                 | 15 M @ 300 (12)     | 15 M @ 450 (18)      | 15 M @ 450 (18)      |
|                          | 2.13 (7.0)                   | 15 M @ 150 (6)                    | 15 M @ 300 (12)     | 15 M @ 300 (12)      | 15 M @ 450 (18)      | 15 M @ 150 (6)                 | 15 M @ 300 (12)     | 15 M @ 300 (12)      | 15 M @ 300 (12)      |
|                          | 2.44 (8.0)                   |                                   | 15 M @ 150 (6)      | 15 M @ 300 (12)      | 15 M @ 300 (12)      |                                | 15 M @ 150 (6)      | 15 M @ 150 (6)       | 15 M @ 300 (12)      |
| 2.74 (9.0)               |                              | 15 M @ 150 (6)                    | 15 M @ 150 (6)      | 15 M @ 300 (12)      |                      | 15 M @ 150 (6)                 | 15 M @ 150 (6)      | 15 M @ 300 (12)      |                      |
| 3.05 (10.0)              |                              |                                   | 15 M @ 150 (6)      | 15 M @ 150 (6)       | 15 M @ 150 (6)       |                                | 15 M @ 150 (6)      | 15 M @ 150 (6)       |                      |
| 3.35 (11.0)              |                              |                                   | 15 M @ 150 (6)      | 15 M @ 150 (6)       | 15 M @ 150 (6)       |                                | 15 M @ 150 (6)      | 15 M @ 150 (6)       |                      |
| 3.66<br>(12.0)           | 1.22 (4.0)                   | 10 M @ 300 (12)                   | 10 M @ 300 (12)     | 10 M @ 300 (12)      | 10 M @ 300 (12)      | 10 M @ 300 (12)                | 10 M @ 300 (12)     | 10 M @ 300 (12)      | 10 M @ 300 (12)      |
|                          | 1.53 (5.0)                   | 15 M @ 300 (12)                   | 15 M @ 450 (18)     | 10 M @ 300 (12)      | 10 M @ 300 (12)      | 15 M @ 300 (12)                | 15 M @ 450 (18)     | 10 M @ 300 (12)      | 10 M @ 300 (12)      |
|                          | 1.83 (6.0)                   | 15 M @ 150 (6)                    | 15 M @ 300 (12)     | 15 M @ 450 (18)      | 15 M @ 450 (18)      | 15 M @ 150 (6)                 | 15 M @ 300 (12)     | 15 M @ 450 (18)      | 15 M @ 450 (18)      |
|                          | 2.13 (7.0)                   | 15 M @ 150 (6)                    | 15 M @ 150 (6)      | 15 M @ 300 (12)      | 15 M @ 300 (12)      | 15 M @ 150 (6)                 | 15 M @ 300 (12)     | 15 M @ 300 (12)      | 15 M @ 300 (12)      |
|                          | 2.44 (8.0)                   |                                   | 15 M @ 150 (6)      | 15 M @ 150 (6)       | 15 M @ 300 (12)      |                                | 15 M @ 150 (6)      | 15 M @ 150 (6)       | 15 M @ 300 (12)      |
| 2.74 (9.0)               |                              | 15 M @ 150 (6)                    | 15 M @ 150 (6)      | 15 M @ 150 (6)       |                      | 15 M @ 150 (6)                 | 15 M @ 150 (6)      | 15 M @ 150 (6)       |                      |
| 3.05 (10.0)              |                              |                                   | 15 M @ 150 (6)      | 15 M @ 150 (6)       | 15 M @ 150 (6)       |                                | 15 M @ 150 (6)      | 15 M @ 150 (6)       |                      |
| 3.35 (11.0)              |                              |                                   | 15 M @ 150 (6)      | 15 M @ 150 (6)       | 15 M @ 150 (6)       |                                | 15 M @ 150 (6)      | 15 M @ 150 (6)       |                      |
| 3.66 (12.0)              |                              |                                   | 15 M @ 150 (6)      | 15 M @ 150 (6)       | 15 M @ 150 (6)       |                                | 15 M @ 150 (6)      | 15 M @ 150 (6)       |                      |
| Horizontal Reinforcement | Block height of 12" and 18"  | 10 M @ 450 (18)                   | 10 M @ 450 (18)     | 10 M @ 450 (18)      | 10 M @ 450 (18)      | 10 M @ 450 (18)                | 10 M @ 450 (18)     | 10 M @ 450 (18)      | 10 M @ 450 (18)      |
|                          | Block Height of 16"          | 10 M @ 400 (16)                   | 10 M @ 400 (16)     | 10 M @ 400 (16)      | 10 M @ 400 (16)      | 10 M @ 400 (16)                | 10 M @ 400 (16)     | 10 M @ 400 (16)      | 10 M @ 400 (16)      |

**NOTES:**

- For highlighted data, where the below grade wall meets all the requirements of NBCC Part 9 for a solid concrete foundation wall and supports only wood frame construction above, a 20MPa unreinforced wall is adequate as per 2020 NBCC table 9.15.4.2.A. Provide the reinforcing shown for walls supporting ICF walls above or with brick veneer supported with the brick ledge form.
- Below grade walls supporting "Drained Earth" in accordance with 2020 NBCC 9.4.4.6 may be designed for an equivalent fluid pressure of 480 kg/m<sup>3</sup>.
- This table is to be used in conjunction with the "Design Limitations" and "Below Grade Reinforcement Placement" drawing.
- Provide 3 horizontal bars in every two rows of 18" high block to achieve an average spacing of 12" o.c. where 12" spacing o.c. is specified for horizontal bars, as shown in Detail A.4.
- Provide 4 horizontal bars in every three rows of 16" high block to achieve an average spacing of 12" o.c. where 12" spacing o.c. is specified for horizontal bars, as shown in Detail A.5.



**Table B.3.1. Continued – Below Grade Wall Distributed Reinforcement for Seismic Zone Classification,  $0.16 < S_{a,ICF} \leq 0.31$  and Hourly Wind Pressure,  $q_{1/50} \leq 1.05kPa$ , for ICF Walls with 6” Tie Spacing**

| Wall Height<br>m<br>(ft)    | Backfill Height<br>m (ft)   | Vertical Steel (Size and Spacing) |                     |                      |                      |                                 |                     |                      |                      |
|-----------------------------|-----------------------------|-----------------------------------|---------------------|----------------------|----------------------|---------------------------------|---------------------|----------------------|----------------------|
|                             |                             | 960 kg/m <sup>3</sup> (60 pcf)    |                     |                      |                      | 1200 kg/m <sup>3</sup> (75 pcf) |                     |                      |                      |
|                             |                             | 150 mm (6")<br>25MPa Wall         | 200 mm (8")<br>Wall | 250 mm (10")<br>Wall | 300 mm (12")<br>Wall | 150 mm (6")<br>25MPa Wall       | 200 mm (8")<br>Wall | 250 mm (10")<br>Wall | 300 mm (12")<br>Wall |
| 2.44<br>(8.0)               | 1.22 (4.0)                  | 15 M @ 450 (18)                   | 10 M @ 300 (12)     | 10 M @ 300 (12)      | 10 M @ 300 (12)      | 15 M @ 450 (18)                 | 10 M @ 300 (12)     | 10 M @ 300 (12)      | 10 M @ 300 (12)      |
|                             | 1.53 (5.0)                  | 15 M @ 300 (12)                   | 15 M @ 450 (18)     | 10 M @ 300 (12)      | 10 M @ 300 (12)      | 15 M @ 300 (12)                 | 15 M @ 450 (18)     | 10 M @ 300 (12)      | 10 M @ 300 (12)      |
|                             | 1.83 (6.0)                  | 15 M @ 150 (6)                    | 15 M @ 450 (18)     | 15 M @ 450 (18)      | 10 M @ 300 (12)      | 15 M @ 150 (6)                  | 15 M @ 450 (18)     | 15 M @ 450 (18)      | 10 M @ 300 (12)      |
|                             | 2.13 (7.0)                  | 15 M @ 150 (6)                    | 15 M @ 300 (12)     | 15 M @ 450 (18)      | 15 M @ 450 (18)      | 15 M @ 150 (6)                  | 15 M @ 300 (12)     | 15 M @ 450 (18)      | 15 M @ 450 (18)      |
|                             | 2.44 (8.0)                  | 15 M @ 150 (6)                    | 15 M @ 300 (12)     | 15 M @ 300 (12)      | 15 M @ 300 (12)      | 15 M @ 150 (6)                  | 15 M @ 150 (6)      | 15 M @ 300 (12)      | 15 M @ 300 (12)      |
| 2.74<br>(9.0)               | 1.22 (4.0)                  | 10 M @ 300 (12)                   | 10 M @ 300 (12)     | 10 M @ 450 (18)      | 10 M @ 300 (12)      | 10 M @ 300 (12)                 | 10 M @ 300 (12)     | 10 M @ 300 (12)      | 10 M @ 300 (12)      |
|                             | 1.53 (5.0)                  | 15 M @ 300 (12)                   | 15 M @ 450 (18)     | 10 M @ 300 (12)      | 10 M @ 300 (12)      | 15 M @ 300 (12)                 | 15 M @ 450 (18)     | 10 M @ 300 (12)      | 10 M @ 300 (12)      |
|                             | 1.83 (6.0)                  | 15 M @ 150 (6)                    | 15 M @ 300 (12)     | 15 M @ 450 (18)      | 15 M @ 450 (18)      | 15 M @ 150 (6)                  | 15 M @ 300 (12)     | 15 M @ 450 (18)      | 15 M @ 450 (18)      |
|                             | 2.13 (7.0)                  | 15 M @ 150 (6)                    | 15 M @ 300 (12)     | 15 M @ 300 (12)      | 15 M @ 450 (18)      | 15 M @ 150 (6)                  | 15 M @ 300 (12)     | 15 M @ 300 (12)      | 15 M @ 300 (12)      |
|                             | 2.44 (8.0)                  |                                   | 15 M @ 150 (6)      | 15 M @ 300 (12)      | 15 M @ 300 (12)      |                                 | 15 M @ 150 (6)      | 15 M @ 300 (12)      | 15 M @ 300 (12)      |
| 3.05<br>(10.0)              | 1.22 (4.0)                  | 10 M @ 300 (12)                   | 10 M @ 300 (12)     | 10 M @ 300 (12)      | 10 M @ 300 (12)      | 10 M @ 300 (12)                 | 10 M @ 300 (12)     | 10 M @ 300 (12)      | 10 M @ 300 (12)      |
|                             | 1.53 (5.0)                  | 15 M @ 300 (12)                   | 15 M @ 450 (18)     | 10 M @ 300 (12)      | 10 M @ 300 (12)      | 15 M @ 300 (12)                 | 15 M @ 450 (18)     | 10 M @ 300 (12)      | 10 M @ 300 (12)      |
|                             | 1.83 (6.0)                  | 15 M @ 150 (6)                    | 15 M @ 300 (12)     | 15 M @ 450 (18)      | 15 M @ 450 (18)      | 15 M @ 150 (6)                  | 15 M @ 300 (12)     | 15 M @ 450 (18)      | 15 M @ 450 (18)      |
|                             | 2.13 (7.0)                  | 15 M @ 150 (6)                    | 15 M @ 150 (6)      | 15 M @ 300 (12)      | 15 M @ 300 (12)      | 15 M @ 150 (6)                  | 15 M @ 300 (12)     | 15 M @ 300 (12)      | 15 M @ 300 (12)      |
|                             | 2.44 (8.0)                  |                                   | 15 M @ 150 (6)      | 15 M @ 150 (6)       | 15 M @ 300 (12)      |                                 | 15 M @ 150 (6)      | 15 M @ 150 (6)       | 15 M @ 300 (12)      |
| 3.35<br>(11.0)              | 1.22 (4.0)                  | 10 M @ 300 (12)                   | 10 M @ 300 (12)     | 10 M @ 300 (12)      | 10 M @ 300 (12)      | 10 M @ 300 (12)                 | 10 M @ 300 (12)     | 10 M @ 300 (12)      | 10 M @ 300 (12)      |
|                             | 1.53 (5.0)                  | 15 M @ 300 (12)                   | 15 M @ 450 (18)     | 10 M @ 300 (12)      | 10 M @ 300 (12)      | 15 M @ 300 (12)                 | 15 M @ 450 (18)     | 15 M @ 450 (18)      | 10 M @ 300 (12)      |
|                             | 1.83 (6.0)                  | 15 M @ 150 (6)                    | 15 M @ 300 (12)     | 15 M @ 450 (18)      | 15 M @ 450 (18)      | 15 M @ 150 (6)                  | 15 M @ 300 (12)     | 15 M @ 450 (18)      | 15 M @ 450 (18)      |
|                             | 2.13 (7.0)                  | 15 M @ 150 (6)                    | 15 M @ 150 (6)      | 15 M @ 300 (12)      | 15 M @ 300 (12)      | 15 M @ 150 (6)                  | 15 M @ 300 (12)     | 15 M @ 300 (12)      | 15 M @ 300 (12)      |
|                             | 2.44 (8.0)                  |                                   | 15 M @ 150 (6)      | 15 M @ 150 (6)       | 15 M @ 300 (12)      |                                 | 15 M @ 150 (6)      | 15 M @ 150 (6)       | 15 M @ 300 (12)      |
| 3.66<br>(12.0)              | 1.22 (4.0)                  | 10 M @ 300 (12)                   | 10 M @ 300 (12)     | 10 M @ 300 (12)      | 10 M @ 300 (12)      | 10 M @ 300 (12)                 | 10 M @ 300 (12)     | 10 M @ 300 (12)      | 10 M @ 300 (12)      |
|                             | 1.53 (5.0)                  | 15 M @ 300 (12)                   | 15 M @ 450 (18)     | 10 M @ 300 (12)      | 10 M @ 300 (12)      | 15 M @ 300 (12)                 | 15 M @ 450 (18)     | 15 M @ 450 (18)      | 10 M @ 300 (12)      |
|                             | 1.83 (6.0)                  | 15 M @ 150 (6)                    | 15 M @ 300 (12)     | 15 M @ 300 (12)      | 15 M @ 450 (18)      | 15 M @ 150 (6)                  | 15 M @ 300 (12)     | 15 M @ 300 (12)      | 15 M @ 450 (18)      |
|                             | 2.13 (7.0)                  |                                   | 15 M @ 150 (6)      | 15 M @ 300 (12)      | 15 M @ 300 (12)      |                                 | 15 M @ 150 (6)      | 15 M @ 300 (12)      | 15 M @ 300 (12)      |
|                             | 2.44 (8.0)                  |                                   | 15 M @ 150 (6)      | 15 M @ 150 (6)       | 15 M @ 300 (12)      |                                 | 15 M @ 150 (6)      | 15 M @ 150 (6)       | 15 M @ 150 (6)       |
| Horizontal<br>Reinforcement | Block height of 12" and 18" | 10 M @ 450 (18)                   | 10 M @ 450 (18)     | 10 M @ 450 (18)      | 10 M @ 450 (18)      | 10 M @ 450 (18)                 | 10 M @ 450 (18)     | 10 M @ 450 (18)      | 10 M @ 450 (18)      |
|                             | Block Height of 16"         | 10 M @ 400 (16)                   | 10 M @ 400 (16)     | 10 M @ 400 (16)      | 10 M @ 400 (16)      | 10 M @ 400 (16)                 | 10 M @ 400 (16)     | 10 M @ 400 (16)      | 10 M @ 400 (16)      |

NOTES:

- For highlighted data, where the below grade wall meets all the requirements of NBCC Part 9 for a solid concrete foundation wall and supports only wood frame construction above, a 20MPa unreinforced wall is adequate as per 2020 NBCC table 9.15.4.2.A. Provide the reinforcing shown for walls supporting ICF walls above or with brick veneer supported with the brick ledge form.
- Below grade walls supporting "Drained Earth" in accordance with 2020 NBCC 9.4.4.6 may be designed for an equivalent fluid pressure of 480 kg/m<sup>3</sup>.
- This table is to be used in conjunction with the "Design Limitations" and "Below Grade Reinforcement Placement" drawing.
- Provide 3 horizontal bars in every two rows of 18" high block to achieve an average spacing of 12" o.c. where 12" spacing o.c. is specified for horizontal bars, as shown in Detail A.4.
- Provide 4 horizontal bars in every three rows of 16" high block to achieve an average spacing of 12" o.c. where 12" spacing o.c. is specified for horizontal bars, as shown in Detail A.5.



**Table B.3.2. – Below Grade Wall Distributed Reinforcement for Seismic Zone Classification, 0.16 <  $S_{a,ICF} \leq 0.31$  and Hourly Wind Pressure,  $q_{1/50} \leq 1.05kPa$ , for ICF Walls with 8" Tie Spacing**

| Wall Height<br>m<br>(ft) | Backfill Height<br>m<br>(ft) | Vertical Steel (Size and Spacing) |                     |                      |                      |                                |                     |                      |                      |
|--------------------------|------------------------------|-----------------------------------|---------------------|----------------------|----------------------|--------------------------------|---------------------|----------------------|----------------------|
|                          |                              | 480 kg/m <sup>3</sup> (30 pcf)    |                     |                      |                      | 720 kg/m <sup>3</sup> (45 pcf) |                     |                      |                      |
|                          |                              | 150 mm (6")<br>25MPa Wall         | 200 mm (8")<br>Wall | 250 mm (10")<br>Wall | 300 mm (12")<br>Wall | 150 mm (6")<br>25MPa Wall      | 200 mm (8")<br>Wall | 250 mm (10")<br>Wall | 300 mm (12")<br>Wall |
| 2.44<br>(8.0)            | 1.22 (4.0)                   | 10 M @ 200 (8)                    | 10 M @ 400 (16)     | 10 M @ 400 (16)      | 10 M @ 400 (16)      | 15 M @ 400 (16)                | 10 M @ 400 (16)     | 10 M @ 400 (16)      | 10 M @ 400 (16)      |
|                          | 1.53 (5.0)                   | 15 M @ 400 (16)                   | 10 M @ 200 (8)      | 10 M @ 400 (16)      | 10 M @ 400 (16)      | 15 M @ 400 (16)                | 10 M @ 200 (8)      | 10 M @ 400 (16)      | 10 M @ 400 (16)      |
|                          | 1.83 (6.0)                   | 15 M @ 200 (8)                    | 15 M @ 400 (16)     | 15 M @ 400 (16)      | 10 M @ 400 (16)      | 15 M @ 200 (8)                 | 15 M @ 400 (16)     | 15 M @ 400 (16)      | 10 M @ 200 (8)       |
|                          | 2.13 (7.0)                   | 15 M @ 200 (8)                    | 15 M @ 400 (16)     | 15 M @ 400 (16)      | 10 M @ 400 (16)      | 15 M @ 200 (8)                 | 15 M @ 400 (16)     | 15 M @ 400 (16)      | 15 M @ 400 (16)      |
|                          | 2.44 (8.0)                   | 15 M @ 200 (8)                    | 15 M @ 200 (8)      | 15 M @ 400 (16)      | 15 M @ 400 (16)      | 15 M @ 200 (8)                 | 15 M @ 200 (8)      | 15 M @ 400 (16)      | 15 M @ 400 (16)      |
| 2.74<br>(9.0)            | 1.22 (4.0)                   | 10 M @ 200 (8)                    | 10 M @ 400 (16)     | 10 M @ 400 (16)      | 10 M @ 400 (16)      | 10 M @ 200 (8)                 | 10 M @ 400 (16)     | 10 M @ 400 (16)      | 10 M @ 400 (16)      |
|                          | 1.53 (5.0)                   | 15 M @ 400 (16)                   | 15 M @ 400 (16)     | 10 M @ 400 (16)      | 10 M @ 400 (16)      | 15 M @ 400 (16)                | 15 M @ 400 (16)     | 10 M @ 200 (8)       | 10 M @ 400 (16)      |
|                          | 1.83 (6.0)                   | 15 M @ 200 (8)                    | 15 M @ 400 (16)     | 15 M @ 400 (16)      | 10 M @ 200 (8)       | 15 M @ 200 (8)                 | 15 M @ 400 (16)     | 15 M @ 400 (16)      | 10 M @ 200 (8)       |
|                          | 2.13 (7.0)                   | 15 M @ 200 (8)                    | 15 M @ 200 (8)      | 15 M @ 400 (16)      | 15 M @ 400 (16)      | 15 M @ 200 (8)                 | 15 M @ 200 (8)      | 15 M @ 400 (16)      | 15 M @ 400 (16)      |
|                          | 2.44 (8.0)                   | 15 M @ 200 (8)                    | 15 M @ 200 (8)      | 15 M @ 400 (16)      | 15 M @ 400 (16)      | 15 M @ 200 (8)                 | 15 M @ 200 (8)      | 15 M @ 400 (16)      | 15 M @ 400 (16)      |
| 2.74 (9.0)               |                              | 15 M @ 200 (8)                    | 15 M @ 200 (8)      | 15 M @ 200 (8)       |                      | 15 M @ 200 (8)                 | 15 M @ 200 (8)      | 15 M @ 200 (8)       |                      |
| 3.05<br>(10.0)           | 1.22 (4.0)                   | 10 M @ 200 (8)                    | 10 M @ 400 (16)     | 10 M @ 400 (16)      | 10 M @ 400 (16)      | 10 M @ 200 (8)                 | 10 M @ 400 (16)     | 10 M @ 400 (16)      | 10 M @ 400 (16)      |
|                          | 1.53 (5.0)                   | 15 M @ 400 (16)                   | 15 M @ 400 (16)     | 10 M @ 200 (8)       | 10 M @ 400 (16)      | 15 M @ 200 (8)                 | 15 M @ 400 (16)     | 10 M @ 200 (8)       | 10 M @ 400 (16)      |
|                          | 1.83 (6.0)                   | 15 M @ 200 (8)                    | 15 M @ 400 (16)     | 15 M @ 400 (16)      | 10 M @ 200 (8)       | 15 M @ 200 (8)                 | 15 M @ 400 (16)     | 15 M @ 400 (16)      | 15 M @ 400 (16)      |
|                          | 2.13 (7.0)                   | 15 M @ 200 (8)                    | 15 M @ 200 (8)      | 15 M @ 400 (16)      | 15 M @ 400 (16)      |                                | 15 M @ 200 (8)      | 15 M @ 400 (16)      | 15 M @ 400 (16)      |
|                          | 2.44 (8.0)                   |                                   | 15 M @ 200 (8)      | 15 M @ 200 (8)       | 15 M @ 200 (8)       |                                | 15 M @ 200 (8)      | 15 M @ 200 (8)       | 15 M @ 200 (8)       |
| 2.74 (9.0)               |                              | 15 M @ 200 (8)                    | 15 M @ 200 (8)      | 15 M @ 200 (8)       |                      | 15 M @ 200 (8)                 | 15 M @ 200 (8)      | 15 M @ 200 (8)       |                      |
| 3.05 (10.0)              |                              |                                   | 15 M @ 200 (8)      | 15 M @ 200 (8)       |                      |                                | 15 M @ 200 (8)      | 15 M @ 200 (8)       |                      |
| 3.35<br>(11.0)           | 1.22 (4.0)                   | 10 M @ 200 (8)                    | 10 M @ 400 (16)     | 10 M @ 400 (16)      | 10 M @ 400 (16)      | 10 M @ 200 (8)                 | 10 M @ 400 (16)     | 10 M @ 400 (16)      | 10 M @ 400 (16)      |
|                          | 1.53 (5.0)                   | 15 M @ 400 (16)                   | 15 M @ 400 (16)     | 10 M @ 200 (8)       | 10 M @ 400 (16)      | 15 M @ 200 (8)                 | 15 M @ 400 (16)     | 10 M @ 200 (8)       | 10 M @ 400 (16)      |
|                          | 1.83 (6.0)                   | 15 M @ 200 (8)                    | 15 M @ 400 (16)     | 15 M @ 400 (16)      | 10 M @ 200 (8)       | 15 M @ 200 (8)                 | 15 M @ 400 (16)     | 15 M @ 400 (16)      | 15 M @ 400 (16)      |
|                          | 2.13 (7.0)                   |                                   | 15 M @ 200 (8)      | 15 M @ 400 (16)      | 15 M @ 400 (16)      |                                | 15 M @ 200 (8)      | 15 M @ 200 (8)       | 15 M @ 400 (16)      |
|                          | 2.44 (8.0)                   |                                   | 15 M @ 200 (8)      | 15 M @ 200 (8)       | 15 M @ 200 (8)       |                                | 15 M @ 200 (8)      | 15 M @ 200 (8)       | 15 M @ 200 (8)       |
| 2.74 (9.0)               |                              |                                   | 15 M @ 200 (8)      | 15 M @ 200 (8)       |                      |                                | 15 M @ 200 (8)      | 15 M @ 200 (8)       |                      |
| 3.05 (10.0)              |                              |                                   | 15 M @ 200 (8)      | 15 M @ 200 (8)       |                      |                                | 15 M @ 200 (8)      | 15 M @ 200 (8)       |                      |
| 3.35 (11.0)              |                              |                                   |                     | 15 M @ 200 (8)       |                      |                                |                     | 15 M @ 200 (8)       |                      |
| 3.66<br>(12.0)           | 1.22 (4.0)                   | 10 M @ 200 (8)                    | 10 M @ 400 (16)     | 10 M @ 400 (16)      | 10 M @ 400 (16)      | 10 M @ 200 (8)                 | 10 M @ 400 (16)     | 10 M @ 400 (16)      | 10 M @ 400 (16)      |
|                          | 1.53 (5.0)                   | 15 M @ 200 (8)                    | 15 M @ 400 (16)     | 10 M @ 200 (8)       | 10 M @ 400 (16)      | 15 M @ 200 (8)                 | 15 M @ 400 (16)     | 10 M @ 200 (8)       | 10 M @ 400 (16)      |
|                          | 1.83 (6.0)                   | 15 M @ 200 (8)                    | 15 M @ 400 (16)     | 15 M @ 400 (16)      | 15 M @ 400 (16)      | 15 M @ 200 (8)                 | 15 M @ 200 (8)      | 15 M @ 400 (16)      | 15 M @ 400 (16)      |
|                          | 2.13 (7.0)                   |                                   | 15 M @ 200 (8)      | 15 M @ 200 (8)       | 15 M @ 400 (16)      |                                | 15 M @ 200 (8)      | 15 M @ 200 (8)       | 15 M @ 200 (8)       |
|                          | 2.44 (8.0)                   |                                   | 15 M @ 200 (8)      | 15 M @ 200 (8)       | 15 M @ 200 (8)       |                                | 15 M @ 200 (8)      | 15 M @ 200 (8)       | 15 M @ 200 (8)       |
| 2.74 (9.0)               |                              |                                   | 15 M @ 200 (8)      | 15 M @ 200 (8)       |                      |                                | 15 M @ 200 (8)      | 15 M @ 200 (8)       |                      |
| 3.05 (10.0)              |                              |                                   | 15 M @ 200 (8)      | 15 M @ 200 (8)       |                      |                                |                     | 15 M @ 200 (8)       |                      |
| 3.35 (11.0)              |                              |                                   |                     | 15 M @ 200 (8)       |                      |                                |                     | 15 M @ 200 (8)       |                      |
| 3.66 (12.0)              |                              |                                   |                     | 15 M @ 200 (8)       |                      |                                |                     | 15 M @ 200 (8)       |                      |
| Horizontal Reinforcement | Block height of 12" and 18"  | 10 M @ 450 (18)                   | 10 M @ 450 (18)     | 10 M @ 450 (18)      | 10 M @ 450 (18)      | 10 M @ 450 (18)                | 10 M @ 450 (18)     | 10 M @ 450 (18)      | 10 M @ 450 (18)      |
|                          | Block Height of 16"          | 10 M @ 400 (16)                   | 10 M @ 400 (16)     | 10 M @ 400 (16)      | 10 M @ 400 (16)      | 10 M @ 400 (16)                | 10 M @ 400 (16)     | 10 M @ 400 (16)      | 10 M @ 400 (16)      |

NOTES:

- For highlighted data, where the below grade wall meets all the requirements of NBCC Part 9 for a solid concrete foundation wall and supports only wood frame construction above, a 20MPa unreinforced wall is adequate as per 2020 NBCC table 9.15.4.2.A. Provide the reinforcing shown for walls supporting ICF walls above or with brick veneer supported with the brick ledge form.
- Below grade walls supporting "Drained Earth" in accordance with 2020 NBCC 9.4.4.6 may be designed for an equivalent fluid pressure of 480 kg/m<sup>3</sup>.
- This table is to be used in conjunction with the "Design Limitations" and "Below Grade Reinforcement Placement" drawing.
- Provide 3 horizontal bars in every two rows of 18" high block to achieve an average spacing of 12" o.c. where 12" spacing o.c. is specified for horizontal bars, as shown in Detail A.4.
- Provide 4 horizontal bars in every three rows of 16" high block to achieve an average spacing of 12" o.c. where 12" spacing o.c. is specified for horizontal bars, as shown in Detail A.5.



**Table B.3.2. Continued– Below Grade Wall Distributed Reinforcement for Seismic Zone Classification,  $0.16 < S_{a,ICF} \leq 0.31$  and Hourly Wind Pressure,  $q_{1/50} \leq 1.05kPa$ , for ICF Walls with 8" Tie Spacing**

| Wall Height<br>m<br>(ft) | Backfill Height<br>m<br>(ft) | Vertical Steel (Size and Spacing) |                     |                      |                      |                                 |                     |                      |                      |
|--------------------------|------------------------------|-----------------------------------|---------------------|----------------------|----------------------|---------------------------------|---------------------|----------------------|----------------------|
|                          |                              | Backfill Equivalent Fluid Density |                     |                      |                      |                                 |                     |                      |                      |
|                          |                              | 960 kg/m <sup>3</sup> (60 pcf)    |                     |                      |                      | 1200 kg/m <sup>3</sup> (75 pcf) |                     |                      |                      |
|                          |                              | 150 mm (6")<br>25MPa Wall         | 200 mm (8")<br>Wall | 250 mm (10")<br>Wall | 300 mm (12")<br>Wall | 150 mm (6")<br>25MPa Wall       | 200 mm (8")<br>Wall | 250 mm (10")<br>Wall | 300 mm (12")<br>Wall |
| 2.44<br>(8.0)            | 1.22 (4.0)                   | 15 M @ 400 (16)                   | 10 M @ 400 (16)     | 10 M @ 400 (16)      | 10 M @ 400 (16)      | 15 M @ 400 (16)                 | 10 M @ 400 (16)     | 10 M @ 400 (16)      | 10 M @ 400 (16)      |
|                          | 1.53 (5.0)                   | 15 M @ 400 (16)                   | 15 M @ 400 (16)     | 10 M @ 400 (16)      | 10 M @ 400 (16)      | 15 M @ 400 (16)                 | 15 M @ 400 (16)     | 10 M @ 200 (8)       | 10 M @ 400 (16)      |
|                          | 1.83 (6.0)                   | 15 M @ 200 (8)                    | 15 M @ 400 (16)     | 15 M @ 400 (16)      | 10 M @ 200 (8)       | 15 M @ 200 (8)                  | 15 M @ 400 (16)     | 15 M @ 400 (16)      | 10 M @ 200 (8)       |
|                          | 2.13 (7.0)                   | 15 M @ 200 (8)                    | 15 M @ 200 (8)      | 15 M @ 400 (16)      | 15 M @ 400 (16)      | 15 M @ 200 (8)                  | 15 M @ 200 (8)      | 15 M @ 400 (16)      | 15 M @ 400 (16)      |
|                          | 2.44 (8.0)                   |                                   | 15 M @ 200 (8)      | 15 M @ 400 (16)      | 15 M @ 400 (16)      |                                 | 15 M @ 200 (8)      | 15 M @ 200 (8)       | 15 M @ 200 (8)       |
| 2.74<br>(9.0)            | 1.22 (4.0)                   | 10 M @ 200 (8)                    | 10 M @ 400 (16)     | 10 M @ 400 (16)      | 10 M @ 400 (16)      | 10 M @ 200 (8)                  | 10 M @ 400 (16)     | 10 M @ 400 (16)      | 10 M @ 400 (16)      |
|                          | 1.53 (5.0)                   | 15 M @ 200 (8)                    | 15 M @ 400 (16)     | 10 M @ 200 (8)       | 10 M @ 400 (16)      | 15 M @ 200 (8)                  | 15 M @ 400 (16)     | 10 M @ 200 (8)       | 10 M @ 400 (16)      |
|                          | 1.83 (6.0)                   | 15 M @ 200 (8)                    | 15 M @ 400 (16)     | 15 M @ 400 (16)      | 15 M @ 400 (16)      | 15 M @ 200 (8)                  | 15 M @ 400 (16)     | 15 M @ 400 (16)      | 15 M @ 400 (16)      |
|                          | 2.13 (7.0)                   |                                   | 15 M @ 200 (8)      | 15 M @ 400 (16)      | 15 M @ 400 (16)      |                                 | 15 M @ 200 (8)      | 15 M @ 400 (16)      | 15 M @ 400 (16)      |
|                          | 2.44 (8.0)                   |                                   | 15 M @ 200 (8)      | 15 M @ 200 (8)       | 15 M @ 200 (8)       |                                 | 15 M @ 200 (8)      | 15 M @ 200 (8)       | 15 M @ 200 (8)       |
|                          | 2.74 (9.0)                   |                                   | 15 M @ 200 (8)      | 15 M @ 200 (8)       | 15 M @ 200 (8)       |                                 | 15 M @ 200 (8)      | 15 M @ 200 (8)       | 15 M @ 200 (8)       |
| 3.05<br>(10.0)           | 1.22 (4.0)                   | 10 M @ 200 (8)                    | 10 M @ 400 (16)     | 10 M @ 400 (16)      | 10 M @ 400 (16)      | 10 M @ 200 (8)                  | 10 M @ 400 (16)     | 10 M @ 400 (16)      | 10 M @ 400 (16)      |
|                          | 1.53 (5.0)                   | 15 M @ 200 (8)                    | 15 M @ 400 (16)     | 10 M @ 200 (8)       | 10 M @ 400 (16)      | 15 M @ 200 (8)                  | 15 M @ 400 (16)     | 10 M @ 200 (8)       | 10 M @ 400 (16)      |
|                          | 1.83 (6.0)                   | 15 M @ 200 (8)                    | 15 M @ 400 (16)     | 15 M @ 400 (16)      | 15 M @ 400 (16)      | 15 M @ 200 (8)                  | 15 M @ 400 (16)     | 15 M @ 400 (16)      | 15 M @ 400 (16)      |
|                          | 2.13 (7.0)                   |                                   | 15 M @ 200 (8)      | 15 M @ 200 (8)       | 15 M @ 400 (16)      |                                 | 15 M @ 200 (8)      | 15 M @ 200 (8)       | 15 M @ 200 (8)       |
|                          | 2.44 (8.0)                   |                                   | 15 M @ 200 (8)      | 15 M @ 200 (8)       | 15 M @ 200 (8)       |                                 | 15 M @ 200 (8)      | 15 M @ 200 (8)       | 15 M @ 200 (8)       |
|                          | 2.74 (9.0)                   |                                   | 15 M @ 200 (8)      | 15 M @ 200 (8)       | 15 M @ 200 (8)       |                                 | 15 M @ 200 (8)      | 15 M @ 200 (8)       | 15 M @ 200 (8)       |
|                          | 3.05 (10.0)                  |                                   |                     | 15 M @ 200 (8)       | 15 M @ 200 (8)       |                                 |                     | 15 M @ 200 (8)       | 15 M @ 200 (8)       |
| 3.35<br>(11.0)           | 1.22 (4.0)                   | 10 M @ 200 (8)                    | 10 M @ 400 (16)     | 10 M @ 400 (16)      | 10 M @ 400 (16)      | 10 M @ 200 (8)                  | 10 M @ 400 (16)     | 10 M @ 400 (16)      | 10 M @ 400 (16)      |
|                          | 1.53 (5.0)                   | 15 M @ 200 (8)                    | 15 M @ 400 (16)     | 10 M @ 200 (8)       | 10 M @ 200 (8)       | 15 M @ 200 (8)                  | 15 M @ 400 (16)     | 15 M @ 400 (16)      | 10 M @ 400 (16)      |
|                          | 1.83 (6.0)                   | 15 M @ 200 (8)                    | 15 M @ 400 (16)     | 15 M @ 400 (16)      | 15 M @ 400 (16)      |                                 | 15 M @ 200 (8)      | 15 M @ 400 (16)      | 15 M @ 400 (16)      |
|                          | 2.13 (7.0)                   |                                   | 15 M @ 200 (8)      | 15 M @ 200 (8)       | 15 M @ 200 (8)       |                                 | 15 M @ 200 (8)      | 15 M @ 200 (8)       | 15 M @ 200 (8)       |
|                          | 2.44 (8.0)                   |                                   |                     | 15 M @ 200 (8)       | 15 M @ 200 (8)       |                                 |                     | 15 M @ 200 (8)       | 15 M @ 200 (8)       |
|                          | 2.74 (9.0)                   |                                   |                     | 15 M @ 200 (8)       | 15 M @ 200 (8)       |                                 |                     | 15 M @ 200 (8)       | 15 M @ 200 (8)       |
|                          | 3.05 (10.0)                  |                                   |                     | 15 M @ 200 (8)       | 15 M @ 200 (8)       |                                 |                     | 15 M @ 200 (8)       | 15 M @ 200 (8)       |
|                          | 3.35 (11.0)                  |                                   |                     |                      | 15 M @ 200 (8)       |                                 |                     | 15 M @ 200 (8)       | 15 M @ 200 (8)       |
| 3.66<br>(12.0)           | 1.22 (4.0)                   | 10 M @ 200 (8)                    | 10 M @ 400 (16)     | 10 M @ 400 (16)      | 10 M @ 400 (16)      | 10 M @ 200 (8)                  | 10 M @ 200 (8)      | 10 M @ 400 (16)      | 10 M @ 400 (16)      |
|                          | 1.53 (5.0)                   | 15 M @ 200 (8)                    | 15 M @ 400 (16)     | 10 M @ 200 (8)       | 10 M @ 400 (16)      | 15 M @ 200 (8)                  | 15 M @ 400 (16)     | 15 M @ 400 (16)      | 10 M @ 200 (8)       |
|                          | 1.83 (6.0)                   |                                   | 15 M @ 200 (8)      | 15 M @ 400 (16)      | 15 M @ 400 (16)      |                                 | 15 M @ 200 (8)      | 15 M @ 400 (16)      | 15 M @ 400 (16)      |
|                          | 2.13 (7.0)                   |                                   | 15 M @ 200 (8)      | 15 M @ 200 (8)       | 15 M @ 200 (8)       |                                 | 15 M @ 200 (8)      | 15 M @ 200 (8)       | 15 M @ 200 (8)       |
|                          | 2.44 (8.0)                   |                                   |                     | 15 M @ 200 (8)       | 15 M @ 200 (8)       |                                 | 15 M @ 200 (8)      | 15 M @ 200 (8)       | 15 M @ 200 (8)       |
|                          | 2.74 (9.0)                   |                                   |                     |                      | 15 M @ 200 (8)       |                                 |                     | 15 M @ 200 (8)       | 15 M @ 200 (8)       |
|                          | 3.05 (10.0)                  |                                   |                     |                      | 15 M @ 200 (8)       |                                 |                     |                      | 15 M @ 200 (8)       |
|                          | 3.35 (11.0)                  |                                   |                     |                      |                      |                                 |                     |                      | 15 M @ 200 (8)       |
|                          | 3.66 (12.0)                  |                                   |                     |                      |                      |                                 |                     |                      | 15 M @ 200 (8)       |
| Horizontal Reinforcement | Block height of 12" and 18"  | 10 M @ 450 (18)                   | 10 M @ 450 (18)     | 10 M @ 450 (18)      | 10 M @ 450 (18)      | 10 M @ 450 (18)                 | 10 M @ 450 (18)     | 10 M @ 450 (18)      | 10 M @ 450 (18)      |
|                          | Block Height of 16"          | 10 M @ 400 (16)                   | 10 M @ 400 (16)     | 10 M @ 400 (16)      | 10 M @ 400 (16)      | 10 M @ 400 (16)                 | 10 M @ 400 (16)     | 10 M @ 400 (16)      | 10 M @ 400 (16)      |

**NOTES:**

- For highlighted data, where the below grade wall meets all the requirements of NBCC Part 9 for a solid concrete foundation wall and supports only wood frame construction above, a 20MPa unreinforced wall is adequate as per 2020 NBCC table 9.15.4.2.A. Provide the reinforcing shown for walls supporting ICF walls above or with brick veneer supported with the brick ledge form.
- Below grade walls supporting "Drained Earth" in accordance with 2020 NBCC 9.4.4.6 may be designed for an equivalent fluid pressure of 480 kg/m<sup>3</sup>.
- This table is to be used in conjunction with the "Design Limitations" and "Below Grade Reinforcement Placement" drawing.
- Provide 3 horizontal bars in every two rows of 18" high block to achieve an average spacing of 12" o.c. where 12" spacing o.c. is specified for horizontal bars, as shown in Detail A.4.
- Provide 4 horizontal bars in every three rows of 16" high block to achieve an average spacing of 12" o.c. where 12" spacing o.c. is specified for horizontal bars, as shown in Detail A.5.



**Table B.4.1. – Below Grade Wall Distributed Reinforcement for Seismic Zone Classification,  $0.31 < S_{a,ICF} \leq 0.79$  and Hourly Wind Pressure,  $q_1/50 \leq 1.05kPa$ , for ICF Walls with 6" Tie Spacing**

| Wall Height<br>m<br>(ft) | Backfill Height<br>m<br>(ft) | Vertical Steel (Size and Spacing) |                     |                      |                      |                                |                     |                      |                      |
|--------------------------|------------------------------|-----------------------------------|---------------------|----------------------|----------------------|--------------------------------|---------------------|----------------------|----------------------|
|                          |                              | Backfill Equivalent Fluid Density |                     |                      |                      |                                |                     |                      |                      |
|                          |                              | 480 kg/m <sup>3</sup> (30 pcf)    |                     |                      |                      | 720 kg/m <sup>3</sup> (45 pcf) |                     |                      |                      |
|                          |                              | 150 mm (6")<br>25MPa Wall         | 200 mm (8")<br>Wall | 250 mm (10")<br>Wall | 300 mm (12")<br>Wall | 150 mm (6")<br>25MPa Wall      | 200 mm (8")<br>Wall | 250 mm (10")<br>Wall | 300 mm (12")<br>Wall |
| 2.44<br>(8.0)            | 1.22 (4.0)                   | 15 M @ 300 (12)                   | 15 M @ 450 (18)     | 10 M @ 300 (12)      | 10 M @ 300 (12)      | 15 M @ 450 (18)                | 15 M @ 450 (18)     | 10 M @ 300 (12)      | 10 M @ 300 (12)      |
|                          | 1.53 (5.0)                   | 15 M @ 300 (12)                   | 15 M @ 450 (18)     | 15 M @ 450 (18)      | 15 M @ 450 (18)      | 15 M @ 150 (6)                 | 15 M @ 450 (18)     | 15 M @ 450 (18)      | 15 M @ 450 (18)      |
|                          | 1.83 (6.0)                   | 15 M @ 150 (6)                    | 15 M @ 300 (12)     | 15 M @ 450 (18)      | 15 M @ 300 (12)      | 15 M @ 150 (6)                 | 15 M @ 300 (12)     | 15 M @ 300 (12)      | 15 M @ 300 (12)      |
|                          | 2.13 (7.0)                   | 15 M @ 150 (6)                    | 15 M @ 150 (6)      | 15 M @ 300 (12)      | 15 M @ 300 (12)      | 15 M @ 150 (6)                 | 15 M @ 150 (6)      | 15 M @ 300 (12)      | 15 M @ 300 (12)      |
|                          | 2.44 (8.0)                   |                                   | 15 M @ 150 (6)      | 15 M @ 300 (12)      | 15 M @ 300 (12)      | 15 M @ 150 (6)                 | 15 M @ 150 (6)      | 15 M @ 150 (6)       | 15 M @ 300 (12)      |
| 2.74<br>(9.0)            | 1.22 (4.0)                   | 15 M @ 450 (18)                   | 15 M @ 450 (18)     | 10 M @ 300 (12)      | 10 M @ 300 (12)      | 15 M @ 450 (18)                | 15 M @ 450 (18)     | 10 M @ 300 (12)      | 10 M @ 300 (12)      |
|                          | 1.53 (5.0)                   | 15 M @ 150 (6)                    | 15 M @ 300 (12)     | 15 M @ 450 (18)      | 15 M @ 450 (18)      | 15 M @ 150 (6)                 | 15 M @ 300 (12)     | 15 M @ 450 (18)      | 15 M @ 450 (18)      |
|                          | 1.83 (6.0)                   | 15 M @ 150 (6)                    | 15 M @ 300 (12)     | 15 M @ 300 (12)      | 15 M @ 300 (12)      | 15 M @ 150 (6)                 | 15 M @ 150 (6)      | 15 M @ 300 (12)      | 15 M @ 300 (12)      |
|                          | 2.13 (7.0)                   |                                   | 15 M @ 150 (6)      | 15 M @ 300 (12)      | 15 M @ 300 (12)      | 15 M @ 150 (6)                 | 15 M @ 150 (6)      | 15 M @ 150 (6)       | 15 M @ 300 (12)      |
|                          | 2.44 (8.0)                   |                                   | 15 M @ 150 (6)      | 15 M @ 150 (6)       | 15 M @ 150 (6)       | 15 M @ 150 (6)                 | 15 M @ 150 (6)      | 15 M @ 150 (6)       | 15 M @ 150 (6)       |
| 3.05<br>(10.0)           | 1.22 (4.0)                   | 15 M @ 300 (12)                   | 15 M @ 450 (18)     | 10 M @ 300 (12)      | 10 M @ 300 (12)      | 15 M @ 300 (12)                | 15 M @ 450 (18)     | 10 M @ 300 (12)      | 10 M @ 300 (12)      |
|                          | 1.53 (5.0)                   | 15 M @ 150 (6)                    | 15 M @ 300 (12)     | 15 M @ 450 (18)      | 15 M @ 450 (18)      | 15 M @ 150 (6)                 | 15 M @ 300 (12)     | 15 M @ 450 (18)      | 15 M @ 300 (12)      |
|                          | 1.83 (6.0)                   | 15 M @ 150 (6)                    | 15 M @ 150 (6)      | 15 M @ 300 (12)      | 15 M @ 300 (12)      | 15 M @ 150 (6)                 | 15 M @ 150 (6)      | 15 M @ 300 (12)      | 15 M @ 300 (12)      |
|                          | 2.13 (7.0)                   |                                   | 15 M @ 150 (6)      | 15 M @ 300 (12)      | 15 M @ 300 (12)      | 15 M @ 150 (6)                 | 15 M @ 150 (6)      | 15 M @ 150 (6)       | 15 M @ 150 (6)       |
|                          | 2.44 (8.0)                   |                                   | 15 M @ 150 (6)      | 15 M @ 150 (6)       | 15 M @ 150 (6)       | 15 M @ 150 (6)                 | 15 M @ 150 (6)      | 15 M @ 150 (6)       | 15 M @ 150 (6)       |
| 3.35<br>(11.0)           | 1.22 (4.0)                   | 15 M @ 300 (12)                   | 10 M @ 300 (12)     | 10 M @ 300 (12)      | 10 M @ 300 (12)      | 15 M @ 300 (12)                | 15 M @ 450 (18)     | 10 M @ 300 (12)      | 10 M @ 300 (12)      |
|                          | 1.53 (5.0)                   | 15 M @ 150 (6)                    | 15 M @ 300 (12)     | 15 M @ 450 (18)      | 15 M @ 300 (12)      | 15 M @ 150 (6)                 | 15 M @ 300 (12)     | 15 M @ 450 (18)      | 15 M @ 300 (12)      |
|                          | 1.83 (6.0)                   | 15 M @ 150 (6)                    | 15 M @ 150 (6)      | 15 M @ 300 (12)      | 15 M @ 300 (12)      | 15 M @ 150 (6)                 | 15 M @ 150 (6)      | 15 M @ 300 (12)      | 15 M @ 300 (12)      |
|                          | 2.13 (7.0)                   |                                   | 15 M @ 150 (6)      | 15 M @ 150 (6)       | 15 M @ 150 (6)       | 15 M @ 150 (6)                 | 15 M @ 150 (6)      | 15 M @ 150 (6)       | 15 M @ 150 (6)       |
|                          | 2.44 (8.0)                   |                                   |                     | 15 M @ 150 (6)       | 15 M @ 150 (6)       | 15 M @ 150 (6)                 | 15 M @ 150 (6)      | 15 M @ 150 (6)       | 15 M @ 150 (6)       |
| 3.66<br>(12.0)           | 1.22 (4.0)                   | 15 M @ 300 (12)                   | 10 M @ 300 (12)     | 10 M @ 300 (12)      | 10 M @ 300 (12)      | 15 M @ 300 (12)                | 15 M @ 450 (18)     | 10 M @ 300 (12)      | 10 M @ 300 (12)      |
|                          | 1.53 (5.0)                   | 15 M @ 150 (6)                    | 15 M @ 300 (12)     | 15 M @ 450 (18)      | 15 M @ 300 (12)      | 15 M @ 150 (6)                 | 15 M @ 300 (12)     | 15 M @ 450 (18)      | 15 M @ 300 (12)      |
|                          | 1.83 (6.0)                   |                                   | 15 M @ 150 (6)      | 15 M @ 300 (12)      | 15 M @ 300 (12)      | 15 M @ 150 (6)                 | 15 M @ 150 (6)      | 15 M @ 150 (6)       | 15 M @ 300 (12)      |
|                          | 2.13 (7.0)                   |                                   | 15 M @ 150 (6)      | 15 M @ 150 (6)       | 15 M @ 150 (6)       | 15 M @ 150 (6)                 | 15 M @ 150 (6)      | 15 M @ 150 (6)       | 15 M @ 150 (6)       |
|                          | 2.44 (8.0)                   |                                   |                     | 15 M @ 150 (6)       | 15 M @ 150 (6)       | 15 M @ 150 (6)                 | 15 M @ 150 (6)      | 15 M @ 150 (6)       | 15 M @ 150 (6)       |
| Horizontal Reinforcement | Block height of 12" and 18"  | 15 M @ 300 (12)                   | 15 M @ 300 (12)     | 15 M @ 300 (12)      | 15 M @ 300 (12)      | 15 M @ 300 (12)                | 15 M @ 300 (12)     | 15 M @ 300 (12)      | 15 M @ 300 (12)      |
|                          | Block Height of 16"          | 15 M @ 300 (12)                   | 15 M @ 300 (12)     | 15 M @ 300 (12)      | 15 M @ 300 (12)      | 15 M @ 300 (12)                | 15 M @ 300 (12)     | 15 M @ 300 (12)      | 15 M @ 300 (12)      |

NOTES:

- For highlighted data, where the below grade wall meets all the requirements of NBCC Part 9 for a solid concrete foundation wall and supports only wood frame construction above, a 20MPa unreinforced wall is adequate as per 2020 NBCC table 9.15.4.2.A. Provide the reinforcing shown for walls supporting ICF walls above or with brick veneer supported with the brick ledge form.
- Below grade walls supporting "Drained Earth" in accordance with 2020 NBCC 9.4.4.6 may be designed for an equivalent fluid pressure of 480 kg/m<sup>3</sup>.
- This table is to be used in conjunction with the "Design Limitations" and "Below Grade Reinforcement Placement" drawing.
- Provide 3 horizontal bars in every two rows of 18" high block to achieve an average spacing of 12" o.c. where 12" spacing o.c. is specified for horizontal bars, as shown in Detail A.4.
- Provide 4 horizontal bars in every three rows of 16" high block to achieve an average spacing of 12" o.c. where 12" spacing o.c. is specified for horizontal bars, as shown in Detail A.5.



**Table B.4.1. Continued– Below Grade Wall Distributed Reinforcement for Seismic Zone Classification,  $0.31 < S_{a,ICF} \leq 0.79$  and Hourly Wind Pressure,  $q_{1/50} \leq 1.05\text{kPa}$ , for ICF Walls with 6" Tie Spacing**

| Wall Height<br>m<br>(ft) | Backfill Height<br>m<br>(ft) | Vertical Steel (Size and Spacing) |                     |                      |                      |                                 |                     |                      |                      |
|--------------------------|------------------------------|-----------------------------------|---------------------|----------------------|----------------------|---------------------------------|---------------------|----------------------|----------------------|
|                          |                              | Backfill Equivalent Fluid Density |                     |                      |                      |                                 |                     |                      |                      |
|                          |                              | 960 kg/m <sup>3</sup> (60 pcf)    |                     |                      |                      | 1200 kg/m <sup>3</sup> (75 pcf) |                     |                      |                      |
|                          |                              | 150 mm (6")<br>25MPa Wall         | 200 mm (8")<br>Wall | 250 mm (10")<br>Wall | 300 mm (12")<br>Wall | 150 mm (6")<br>25MPa Wall       | 200 mm (8")<br>Wall | 250 mm (10")<br>Wall | 300 mm (12")<br>Wall |
| 2.44<br>(8.0)            | 1.22 (4.0)                   | 15 M @ 450 (18)                   | 15 M @ 450 (18)     | 10 M @ 300 (12)      | 10 M @ 300 (12)      | 15 M @ 300 (12)                 | 15 M @ 450 (18)     | 10 M @ 300 (12)      | 10 M @ 300 (12)      |
|                          | 1.53 (5.0)                   | 15 M @ 150 (6)                    | 15 M @ 450 (18)     | 15 M @ 450 (18)      | 15 M @ 450 (18)      | 15 M @ 150 (6)                  | 15 M @ 300 (12)     | 15 M @ 450 (18)      | 15 M @ 450 (18)      |
|                          | 1.83 (6.0)                   | 15 M @ 150 (6)                    | 15 M @ 300 (12)     | 15 M @ 300 (12)      | 15 M @ 300 (12)      | 15 M @ 150 (6)                  | 15 M @ 150 (6)      | 15 M @ 300 (12)      | 15 M @ 300 (12)      |
|                          | 2.13 (7.0)                   |                                   | 15 M @ 150 (6)      | 15 M @ 300 (12)      | 15 M @ 300 (12)      |                                 | 15 M @ 150 (6)      | 15 M @ 300 (12)      | 15 M @ 300 (12)      |
|                          | 2.44 (8.0)                   |                                   |                     | 15 M @ 150 (6)       | 15 M @ 150 (6)       | 15 M @ 300 (12)                 |                     | 15 M @ 150 (6)       | 15 M @ 150 (6)       |
| 2.74<br>(9.0)            | 1.22 (4.0)                   | 15 M @ 300 (12)                   | 15 M @ 450 (18)     | 10 M @ 300 (12)      | 10 M @ 300 (12)      | 15 M @ 300 (12)                 | 15 M @ 450 (18)     | 10 M @ 300 (12)      | 10 M @ 300 (12)      |
|                          | 1.53 (5.0)                   | 15 M @ 150 (6)                    | 15 M @ 300 (12)     | 15 M @ 450 (18)      | 10 M @ 150 (6)       | 15 M @ 150 (6)                  | 15 M @ 300 (12)     | 15 M @ 450 (18)      | 15 M @ 300 (12)      |
|                          | 1.83 (6.0)                   | 15 M @ 150 (6)                    | 15 M @ 150 (6)      | 15 M @ 300 (12)      | 15 M @ 300 (12)      | 15 M @ 150 (6)                  | 15 M @ 150 (6)      | 15 M @ 300 (12)      | 15 M @ 300 (12)      |
|                          | 2.13 (7.0)                   |                                   | 15 M @ 150 (6)      | 15 M @ 150 (6)       | 15 M @ 300 (12)      |                                 | 15 M @ 150 (6)      | 15 M @ 150 (6)       | 15 M @ 300 (12)      |
|                          | 2.44 (8.0)                   |                                   |                     | 15 M @ 150 (6)       | 15 M @ 150 (6)       | 15 M @ 150 (6)                  |                     | 15 M @ 150 (6)       | 15 M @ 150 (6)       |
| 3.05<br>(10.0)           | 1.22 (4.0)                   | 15 M @ 300 (12)                   | 15 M @ 450 (18)     | 10 M @ 300 (12)      | 10 M @ 300 (12)      | 15 M @ 300 (12)                 | 15 M @ 450 (18)     | 10 M @ 300 (12)      | 10 M @ 300 (12)      |
|                          | 1.53 (5.0)                   | 15 M @ 150 (6)                    | 15 M @ 300 (12)     | 15 M @ 450 (18)      | 15 M @ 300 (12)      | 15 M @ 150 (6)                  | 15 M @ 300 (12)     | 15 M @ 450 (18)      | 15 M @ 300 (12)      |
|                          | 1.83 (6.0)                   | 15 M @ 150 (6)                    | 15 M @ 150 (6)      | 15 M @ 300 (12)      | 15 M @ 300 (12)      |                                 | 15 M @ 150 (6)      | 15 M @ 300 (12)      | 15 M @ 300 (12)      |
|                          | 2.13 (7.0)                   |                                   | 15 M @ 150 (6)      | 15 M @ 150 (6)       | 15 M @ 150 (6)       |                                 | 15 M @ 150 (6)      | 15 M @ 150 (6)       | 15 M @ 150 (6)       |
|                          | 2.44 (8.0)                   |                                   |                     | 15 M @ 150 (6)       | 15 M @ 150 (6)       | 15 M @ 150 (6)                  |                     | 15 M @ 150 (6)       | 15 M @ 150 (6)       |
| 3.35<br>(11.0)           | 1.22 (4.0)                   | 15 M @ 300 (12)                   | 15 M @ 450 (18)     | 10 M @ 300 (12)      | 10 M @ 300 (12)      | 15 M @ 300 (12)                 | 15 M @ 450 (18)     | 10 M @ 300 (12)      | 10 M @ 300 (12)      |
|                          | 1.53 (5.0)                   | 15 M @ 150 (6)                    | 15 M @ 300 (12)     | 15 M @ 450 (18)      | 15 M @ 300 (12)      | 15 M @ 150 (6)                  | 15 M @ 300 (12)     | 15 M @ 300 (12)      | 15 M @ 300 (12)      |
|                          | 1.83 (6.0)                   |                                   | 15 M @ 150 (6)      | 15 M @ 150 (6)       | 15 M @ 300 (12)      |                                 | 15 M @ 150 (6)      | 15 M @ 150 (6)       | 15 M @ 300 (12)      |
|                          | 2.13 (7.0)                   |                                   | 15 M @ 150 (6)      | 15 M @ 150 (6)       | 15 M @ 150 (6)       |                                 | 15 M @ 150 (6)      | 15 M @ 150 (6)       | 15 M @ 300 (12)      |
|                          | 2.44 (8.0)                   |                                   |                     | 15 M @ 150 (6)       | 15 M @ 150 (6)       | 15 M @ 150 (6)                  |                     | 15 M @ 150 (6)       | 15 M @ 150 (6)       |
| 3.66<br>(12.0)           | 1.22 (4.0)                   | 15 M @ 300 (12)                   | 10 M @ 300 (12)     | 10 M @ 300 (12)      | 10 M @ 300 (12)      | 15 M @ 300 (12)                 | 15 M @ 450 (18)     | 10 M @ 300 (12)      | 10 M @ 300 (12)      |
|                          | 1.53 (5.0)                   | 15 M @ 150 (6)                    | 15 M @ 300 (12)     | 15 M @ 450 (18)      | 15 M @ 300 (12)      | 15 M @ 150 (6)                  | 15 M @ 300 (12)     | 15 M @ 300 (12)      | 15 M @ 300 (12)      |
|                          | 1.83 (6.0)                   |                                   | 15 M @ 150 (6)      | 15 M @ 150 (6)       | 15 M @ 300 (12)      |                                 | 15 M @ 150 (6)      | 15 M @ 150 (6)       | 15 M @ 300 (12)      |
|                          | 2.13 (7.0)                   |                                   |                     | 15 M @ 150 (6)       | 15 M @ 150 (6)       |                                 | 15 M @ 150 (6)      | 15 M @ 150 (6)       | 15 M @ 150 (6)       |
|                          | 2.44 (8.0)                   |                                   |                     |                      | 15 M @ 150 (6)       | 15 M @ 150 (6)                  |                     | 15 M @ 150 (6)       | 15 M @ 150 (6)       |
| Horizontal Reinforcement | Block height of 12" and 18"  | 15 M @ 300 (12)                   | 15 M @ 300 (12)     | 15 M @ 300 (12)      | 15 M @ 300 (12)      | 15 M @ 300 (12)                 | 15 M @ 300 (12)     | 15 M @ 300 (12)      | 15 M @ 300 (12)      |
|                          | Block Height of 16"          | 15 M @ 300 (12)                   | 15 M @ 300 (12)     | 15 M @ 300 (12)      | 15 M @ 300 (12)      | 15 M @ 300 (12)                 | 15 M @ 300 (12)     | 15 M @ 300 (12)      | 15 M @ 300 (12)      |

NOTES:

- For highlighted data, where the below grade wall meets all the requirements of NBCC Part 9 for a solid concrete foundation wall and supports only wood frame construction above, a 20MPa unreinforced wall is adequate as per 2020 NBCC table 9.15.4.2.A. Provide the reinforcing shown for walls supporting ICF walls above or with brick veneer supported with the brick ledge form.
- Below grade walls supporting "Drained Earth" in accordance with 2020 NBCC 9.4.4.6 may be designed for an equivalent fluid pressure of 480 kg/m<sup>3</sup>.
- This table is to be used in conjunction with the "Design Limitations" and "Below Grade Reinforcement Placement" drawing.
- Provide 3 horizontal bars in every two rows of 18" high block to achieve an average spacing of 12" o.c. where 12" spacing o.c. is specified for horizontal bars, as shown in Detail A.4.
- Provide 4 horizontal bars in every three rows of 16" high block to achieve an average spacing of 12" o.c. where 12" spacing o.c. is specified for horizontal bars, as shown in Detail A.5.



**Table B.4.2. – Below Grade Wall Distributed Reinforcement for Seismic Zone Classification,  $0.31 < S_{a,ICF} \leq 0.79$  and Hourly Wind Pressure,  $q1/50 \leq 1.05kPa$ , for ICF Walls with 8" Tie Spacing**

| Wall Height<br>m<br>(ft) | Backfill Height<br>m<br>(ft) | Vertical Steel (Size and Spacing) |                     |                      |                      |                                |                     |                      |                      |
|--------------------------|------------------------------|-----------------------------------|---------------------|----------------------|----------------------|--------------------------------|---------------------|----------------------|----------------------|
|                          |                              | Backfill Equivalent Fluid Density |                     |                      |                      |                                |                     |                      |                      |
|                          |                              | 480 kg/m <sup>3</sup> (30 pcf)    |                     |                      |                      | 720 kg/m <sup>3</sup> (45 pcf) |                     |                      |                      |
|                          |                              | 150 mm (6")<br>25MPa Wall         | 200 mm (8")<br>Wall | 250 mm (10")<br>Wall | 300 mm (12")<br>Wall | 150 mm (6")<br>25MPa Wall      | 200 mm (8")<br>Wall | 250 mm (10")<br>Wall | 300 mm (12")<br>Wall |
| 2.44<br>(8.0)            | 1.22 (4.0)                   | 15 M @ 400 (16)                   | 15 M @ 400 (16)     | 15 M @ 600 (24)      | 10 M @ 400 (16)      | 15 M @ 400 (16)                | 15 M @ 400 (16)     | 10 M @ 200 (8)       | 10 M @ 400 (16)      |
|                          | 1.53 (5.0)                   | 15 M @ 200 (8)                    | 15 M @ 400 (16)     | 15 M @ 400 (16)      | 10 M @ 200 (8)       | 15 M @ 200 (8)                 | 15 M @ 400 (16)     | 15 M @ 400 (16)      | 10 M @ 200 (8)       |
|                          | 1.83 (6.0)                   | 15 M @ 200 (8)                    | 15 M @ 200 (8)      | 15 M @ 400 (16)      | 15 M @ 200 (8)       | 15 M @ 200 (8)                 | 15 M @ 200 (8)      | 15 M @ 400 (16)      | 15 M @ 200 (8)       |
|                          | 2.13 (7.0)                   |                                   | 15 M @ 200 (8)      | 15 M @ 200 (8)       | 15 M @ 200 (8)       | 15 M @ 200 (8)                 | 15 M @ 200 (8)      | 15 M @ 200 (8)       | 15 M @ 200 (8)       |
|                          | 2.44 (8.0)                   |                                   | 15 M @ 200 (8)      | 15 M @ 200 (8)       | 15 M @ 200 (8)       | 15 M @ 200 (8)                 | 15 M @ 200 (8)      | 15 M @ 200 (8)       | 15 M @ 200 (8)       |
| 2.74<br>(9.0)            | 1.22 (4.0)                   | 15 M @ 400 (16)                   | 10 M @ 200 (8)      | 10 M @ 200 (8)       | 10 M @ 400 (16)      | 15 M @ 400 (16)                | 10 M @ 200 (8)      | 10 M @ 200 (8)       | 10 M @ 400 (16)      |
|                          | 1.53 (5.0)                   | 15 M @ 200 (8)                    | 15 M @ 400 (16)     | 15 M @ 400 (16)      | 15 M @ 400 (16)      | 15 M @ 200 (8)                 | 15 M @ 400 (16)     | 15 M @ 400 (16)      | 15 M @ 400 (16)      |
|                          | 1.83 (6.0)                   |                                   | 15 M @ 200 (8)      | 15 M @ 200 (8)       | 15 M @ 200 (8)       | 15 M @ 200 (8)                 | 15 M @ 200 (8)      | 15 M @ 200 (8)       | 15 M @ 200 (8)       |
|                          | 2.13 (7.0)                   |                                   | 15 M @ 200 (8)      | 15 M @ 200 (8)       | 15 M @ 200 (8)       | 15 M @ 200 (8)                 | 15 M @ 200 (8)      | 15 M @ 200 (8)       | 15 M @ 200 (8)       |
|                          | 2.44 (8.0)                   |                                   |                     | 15 M @ 200 (8)       | 15 M @ 200 (8)       |                                |                     | 15 M @ 200 (8)       | 15 M @ 200 (8)       |
| 3.05<br>(10.0)           | 1.22 (4.0)                   | 15 M @ 400 (16)                   | 10 M @ 200 (8)      | 10 M @ 200 (8)       | 10 M @ 400 (16)      | 15 M @ 400 (16)                | 10 M @ 200 (8)      | 10 M @ 200 (8)       | 10 M @ 400 (16)      |
|                          | 1.53 (5.0)                   | 15 M @ 200 (8)                    | 15 M @ 400 (16)     | 15 M @ 400 (16)      | 15 M @ 400 (16)      | 15 M @ 200 (8)                 | 15 M @ 200 (8)      | 15 M @ 400 (16)      | 15 M @ 400 (16)      |
|                          | 1.83 (6.0)                   |                                   | 15 M @ 200 (8)      | 15 M @ 200 (8)       | 15 M @ 200 (8)       |                                | 15 M @ 200 (8)      | 15 M @ 200 (8)       | 15 M @ 200 (8)       |
|                          | 2.13 (7.0)                   |                                   |                     | 15 M @ 200 (8)       | 15 M @ 200 (8)       |                                |                     | 15 M @ 200 (8)       | 15 M @ 200 (8)       |
|                          | 2.44 (8.0)                   |                                   |                     | 15 M @ 200 (8)       | 15 M @ 200 (8)       |                                |                     | 15 M @ 200 (8)       | 15 M @ 200 (8)       |
| 3.35<br>(11.0)           | 1.22 (4.0)                   | 15 M @ 400 (16)                   | 10 M @ 200 (8)      | 10 M @ 200 (8)       | 10 M @ 400 (16)      | 15 M @ 400 (16)                | 10 M @ 200 (8)      | 10 M @ 200 (8)       | 15 M @ 400 (16)      |
|                          | 1.53 (5.0)                   | 15 M @ 200 (8)                    | 15 M @ 200 (8)      | 15 M @ 400 (16)      | 15 M @ 400 (16)      | 15 M @ 200 (8)                 | 15 M @ 200 (8)      | 15 M @ 400 (16)      | 15 M @ 400 (16)      |
|                          | 1.83 (6.0)                   |                                   | 15 M @ 200 (8)      | 15 M @ 200 (8)       | 15 M @ 200 (8)       |                                | 15 M @ 200 (8)      | 15 M @ 200 (8)       | 15 M @ 200 (8)       |
|                          | 2.13 (7.0)                   |                                   |                     | 15 M @ 200 (8)       | 15 M @ 200 (8)       |                                |                     | 15 M @ 200 (8)       | 15 M @ 200 (8)       |
|                          | 2.44 (8.0)                   |                                   |                     |                      | 15 M @ 200 (8)       |                                |                     | 15 M @ 200 (8)       | 15 M @ 200 (8)       |
| 3.66<br>(12.0)           | 1.22 (4.0)                   | 15 M @ 400 (16)                   | 10 M @ 200 (8)      | 10 M @ 200 (8)       | 15 M @ 600 (24)      | 15 M @ 400 (16)                | 10 M @ 200 (8)      | 10 M @ 200 (8)       | 15 M @ 400 (16)      |
|                          | 1.53 (5.0)                   | 15 M @ 200 (8)                    | 15 M @ 200 (8)      | 15 M @ 400 (16)      | 15 M @ 400 (16)      | 15 M @ 200 (8)                 | 15 M @ 200 (8)      | 15 M @ 400 (16)      | 15 M @ 400 (16)      |
|                          | 1.83 (6.0)                   |                                   | 15 M @ 200 (8)      | 15 M @ 200 (8)       | 15 M @ 200 (8)       | 15 M @ 200 (8)                 | 15 M @ 200 (8)      | 15 M @ 200 (8)       | 15 M @ 200 (8)       |
|                          | 2.13 (7.0)                   |                                   |                     | 15 M @ 200 (8)       | 15 M @ 200 (8)       |                                |                     | 15 M @ 200 (8)       | 15 M @ 200 (8)       |
|                          | 2.44 (8.0)                   |                                   |                     |                      | 15 M @ 200 (8)       |                                |                     | 15 M @ 200 (8)       | 15 M @ 200 (8)       |
| Horizontal Reinforcement | Block height of 12" and 18"  | 15 M @ 300 (12)                   | 15 M @ 300 (12)     | 15 M @ 300 (12)      | 15 M @ 300 (12)      | 15 M @ 300 (12)                | 15 M @ 300 (12)     | 15 M @ 300 (12)      | 15 M @ 300 (12)      |
|                          | Block Height of 16"          | 15 M @ 300 (12)                   | 15 M @ 300 (12)     | 15 M @ 300 (12)      | 15 M @ 300 (12)      | 15 M @ 300 (12)                | 15 M @ 300 (12)     | 15 M @ 300 (12)      | 15 M @ 300 (12)      |

**NOTES:**

- For highlighted data, where the below grade wall meets all the requirements of NBCC Part 9 for a solid concrete foundation wall and supports only wood frame construction above, a 20MPa unreinforced wall is adequate as per 2020 NBCC table 9.15.4.2.A. Provide the reinforcing shown for walls supporting ICF walls above or with brick veneer supported with the brick ledge form.
- Below grade walls supporting "Drained Earth" in accordance with 2020 NBCC 9.4.4.6 may be designed for an equivalent fluid pressure of 480 kg/m<sup>3</sup>.
- This table is to be used in conjunction with the "Design Limitations" and "Below Grade Reinforcement Placement" drawing.
- Provide 3 horizontal bars in every two rows of 18" high block to achieve an average spacing of 12" o.c. where 12" spacing o.c. is specified for horizontal bars, as shown in Detail A.4.
- Provide 4 horizontal bars in every three rows of 16" high block to achieve an average spacing of 12" o.c. where 12" spacing o.c. is specified for horizontal bars, as shown in Detail A.5.



**Table B.4.2. Continued– Below Grade Wall Distributed Reinforcement for Seismic Zone Classification,  $0.31 < S_{a,ICF} \leq 0.79$  and Hourly Wind Pressure,  $q_{1/50} \leq 1.05\text{kPa}$ , for ICF Walls with 8” Tie Spacing**

| Wall Height<br>m<br>(ft)    | Backfill Height<br>m<br>(ft) | Vertical Steel (Size and Spacing) |                     |                      |                      |                                 |                     |                      |                      |
|-----------------------------|------------------------------|-----------------------------------|---------------------|----------------------|----------------------|---------------------------------|---------------------|----------------------|----------------------|
|                             |                              | Backfill Equivalent Fluid Density |                     |                      |                      |                                 |                     |                      |                      |
|                             |                              | 960 kg/m <sup>3</sup> (60 pcf)    |                     |                      |                      | 1200 kg/m <sup>3</sup> (75 pcf) |                     |                      |                      |
|                             |                              | 150 mm (6")<br>25MPa Wall         | 200 mm (8")<br>Wall | 250 mm (10")<br>Wall | 300 mm (12")<br>Wall | 150 mm (6")<br>25MPa Wall       | 200 mm (8")<br>Wall | 250 mm (10")<br>Wall | 300 mm (12")<br>Wall |
| 2.44<br>(8.0)               | 1.22 (4.0)                   | 15 M @ 400 (16)                   | 10 M @ 200 (8)      | 10 M @ 200 (8)       | 10 M @ 400 (16)      | 15 M @ 400 (16)                 | 10 M @ 200 (8)      | 10 M @ 200 (8)       | 15 M @ 400 (16)      |
|                             | 1.53 (5.0)                   | 15 M @ 200 (8)                    | 15 M @ 400 (16)     | 15 M @ 400 (16)      | 10 M @ 200 (8)       | 15 M @ 200 (8)                  | 15 M @ 400 (16)     | 15 M @ 400 (16)      | 15 M @ 400 (16)      |
|                             | 1.83 (6.0)                   |                                   | 15 M @ 200 (8)      | 15 M @ 400 (16)      | 15 M @ 200 (8)       | 15 M @ 200 (8)                  | 15 M @ 200 (8)      | 15 M @ 200 (8)       | 15 M @ 200 (8)       |
|                             | 2.13 (7.0)                   |                                   | 15 M @ 200 (8)      | 15 M @ 200 (8)       | 15 M @ 200 (8)       | 15 M @ 200 (8)                  | 15 M @ 200 (8)      | 15 M @ 200 (8)       | 15 M @ 200 (8)       |
|                             | 2.44 (8.0)                   |                                   |                     | 15 M @ 200 (8)       | 15 M @ 200 (8)       | 15 M @ 200 (8)                  |                     | 15 M @ 200 (8)       | 15 M @ 200 (8)       |
| 2.74<br>(9.0)               | 1.22 (4.0)                   | 15 M @ 400 (16)                   | 10 M @ 200 (8)      | 10 M @ 200 (8)       | 15 M @ 400 (16)      | 15 M @ 400 (16)                 | 10 M @ 200 (8)      | 10 M @ 200 (8)       | 15 M @ 400 (16)      |
|                             | 1.53 (5.0)                   | 15 M @ 200 (8)                    | 15 M @ 400 (16)     | 15 M @ 400 (16)      | 15 M @ 400 (16)      | 15 M @ 200 (8)                  | 15 M @ 200 (8)      | 15 M @ 400 (16)      | 15 M @ 400 (16)      |
|                             | 1.83 (6.0)                   |                                   | 15 M @ 200 (8)      | 15 M @ 200 (8)       | 15 M @ 200 (8)       |                                 | 15 M @ 200 (8)      | 15 M @ 200 (8)       | 15 M @ 200 (8)       |
|                             | 2.13 (7.0)                   |                                   |                     | 15 M @ 200 (8)       | 15 M @ 200 (8)       | 15 M @ 200 (8)                  | 15 M @ 200 (8)      | 15 M @ 200 (8)       | 15 M @ 200 (8)       |
|                             | 2.44 (8.0)                   |                                   |                     | 15 M @ 200 (8)       | 15 M @ 200 (8)       |                                 |                     | 15 M @ 200 (8)       | 15 M @ 200 (8)       |
| 3.05<br>(10.0)              | 1.22 (4.0)                   | 15 M @ 400 (16)                   | 10 M @ 200 (8)      | 10 M @ 200 (8)       | 15 M @ 400 (16)      | 15 M @ 400 (16)                 | 10 M @ 200 (8)      | 15 M @ 600 (24)      | 15 M @ 400 (16)      |
|                             | 1.53 (5.0)                   | 15 M @ 200 (8)                    | 15 M @ 200 (8)      | 15 M @ 400 (16)      | 15 M @ 400 (16)      | 15 M @ 200 (8)                  | 15 M @ 200 (8)      | 15 M @ 400 (16)      | 15 M @ 400 (16)      |
|                             | 1.83 (6.0)                   |                                   | 15 M @ 200 (8)      | 15 M @ 200 (8)       | 15 M @ 200 (8)       |                                 | 15 M @ 200 (8)      | 15 M @ 200 (8)       | 15 M @ 200 (8)       |
|                             | 2.13 (7.0)                   |                                   |                     | 15 M @ 200 (8)       | 15 M @ 200 (8)       | 15 M @ 200 (8)                  | 15 M @ 200 (8)      | 15 M @ 200 (8)       | 15 M @ 200 (8)       |
|                             | 2.44 (8.0)                   |                                   |                     |                      | 15 M @ 200 (8)       |                                 |                     | 15 M @ 200 (8)       | 15 M @ 200 (8)       |
| 3.35<br>(11.0)              | 1.22 (4.0)                   | 15 M @ 400 (16)                   | 10 M @ 200 (8)      | 10 M @ 200 (8)       | 15 M @ 400 (16)      | 15 M @ 200 (8)                  | 10 M @ 200 (8)      | 15 M @ 600 (24)      | 15 M @ 400 (16)      |
|                             | 1.53 (5.0)                   | 15 M @ 200 (8)                    | 15 M @ 200 (8)      | 15 M @ 400 (16)      | 15 M @ 400 (16)      |                                 | 15 M @ 200 (8)      | 15 M @ 400 (16)      | 15 M @ 200 (8)       |
|                             | 1.83 (6.0)                   |                                   | 15 M @ 200 (8)      | 15 M @ 200 (8)       | 15 M @ 200 (8)       |                                 | 15 M @ 200 (8)      | 15 M @ 200 (8)       | 15 M @ 200 (8)       |
|                             | 2.13 (7.0)                   |                                   |                     | 15 M @ 200 (8)       | 15 M @ 200 (8)       | 15 M @ 200 (8)                  | 15 M @ 200 (8)      | 15 M @ 200 (8)       | 15 M @ 200 (8)       |
|                             | 2.44 (8.0)                   |                                   |                     |                      | 15 M @ 200 (8)       |                                 |                     | 15 M @ 200 (8)       | 15 M @ 200 (8)       |
| 3.66<br>(12.0)              | 1.22 (4.0)                   | 15 M @ 400 (16)                   | 10 M @ 200 (8)      | 10 M @ 200 (8)       | 15 M @ 400 (16)      | 15 M @ 200 (8)                  | 10 M @ 200 (8)      | 15 M @ 600 (24)      | 15 M @ 400 (16)      |
|                             | 1.53 (5.0)                   | 15 M @ 200 (8)                    | 15 M @ 200 (8)      | 15 M @ 400 (16)      | 15 M @ 200 (8)       |                                 | 15 M @ 200 (8)      | 15 M @ 400 (16)      | 15 M @ 200 (8)       |
|                             | 1.83 (6.0)                   |                                   | 15 M @ 200 (8)      | 15 M @ 200 (8)       | 15 M @ 200 (8)       |                                 | 15 M @ 200 (8)      | 15 M @ 200 (8)       | 15 M @ 200 (8)       |
|                             | 2.13 (7.0)                   |                                   |                     |                      | 15 M @ 200 (8)       | 15 M @ 200 (8)                  | 15 M @ 200 (8)      | 15 M @ 200 (8)       | 15 M @ 200 (8)       |
|                             | 2.44 (8.0)                   |                                   |                     |                      |                      |                                 |                     | 15 M @ 200 (8)       | 15 M @ 200 (8)       |
| Horizontal<br>Reinforcement | Block height of 12" and 18"  | 15 M @ 300 (12)                   | 15 M @ 300 (12)     | 15 M @ 300 (12)      | 15 M @ 300 (12)      | 15 M @ 300 (12)                 | 15 M @ 300 (12)     | 15 M @ 300 (12)      | 15 M @ 300 (12)      |
|                             | Block Height of 16"          | 15 M @ 300 (12)                   | 15 M @ 300 (12)     | 15 M @ 300 (12)      | 15 M @ 300 (12)      | 15 M @ 300 (12)                 | 15 M @ 300 (12)     | 15 M @ 300 (12)      | 15 M @ 300 (12)      |

NOTES:

- For highlighted data, where the below grade wall meets all the requirements of NBCC Part 9 for a solid concrete foundation wall and supports only wood frame construction above, a 20MPa unreinforced wall is adequate as per 2020 NBCC table 9.15.4.2.A. Provide the reinforcing shown for walls supporting ICF walls above or with brick veneer supported with the brick ledge form.
- Below grade walls supporting "Drained Earth" in accordance with 2020 NBCC 9.4.4.6 may be designed for an equivalent fluid pressure of 480 kg/m<sup>3</sup>.
- This table is to be used in conjunction with the "Design Limitations" and "Below Grade Reinforcement Placement" drawing.
- Provide 3 horizontal bars in every two rows of 18" high block to achieve an average spacing of 12" o.c. where 12" spacing o.c. is specified for horizontal bars, as shown in Detail A.4.
- Provide 4 horizontal bars in every three rows of 16" high block to achieve an average spacing of 12" o.c. where 12" spacing o.c. is specified for horizontal bars, as shown in Detail A.5.



**Table A.1.1. Above Grade Wall Distributed Reinforcement for Seismic Zone Classification,  $S_{a,ICF} \leq 0.16$  and Hourly Wind Pressure,  $q_{1/50} \leq 1.05\text{kPa}$ , for ICF Walls with **6" Tie Spacing****

| Wall Height<br>m (ft)  | Distributed Vertical Reinforcement (Size and Spacing) |                        |                        |                         |                 |
|--|---|------------------------|------------------------|-------------------------|-----------------|
|  | 150 mm (6") 25MPa Wall                                | 200 mm (8") Wall       | 250 mm (10") Wall      | 300 mm (12") Wall       |                 |
| <b>Hourly Wind Pressure <math>q_{1/50} \leq 0.5\text{ kPa}</math></b>  |   |                        |                        |                         |                 |
| 2.44 (8)   | 10 M @ 600 (24)                                       | 10 M @ 750 (30)        | 10 M @ 900 (36)        | 10 M @ 1200 (48)        |                 |
| 2.75 (9)   | 10 M @ 600 (24)                                       | 10 M @ 750 (30)        | 10 M @ 900 (36)        | 10 M @ 1200 (48)        |                 |
| 3.05 (10)  | 15 M @ 900 (36)                                       | 10 M @ 750 (30)        | 10 M @ 900 (36)        | 10 M @ 1200 (48)        |                 |
| 3.66 (12)  | <b>15 M @ 750 (30)</b>                                | <b>15 M @ 900 (36)</b> | <b>10 M @ 600 (24)</b> | <b>10 M @ 1200 (48)</b> |                 |
| 4.27 (14)  | <b>15 M @ 300 (12)</b>                                | <b>15 M @ 750 (30)</b> | <b>15 M @ 900 (36)</b> | <b>10 M @ 1200 (48)</b> |                 |
| 4.88 (16)  | <b>15 M @ 300 (12)</b>                                | <b>15 M @ 600 (24)</b> | <b>15 M @ 750 (30)</b> | <b>10 M @ 900 (36)</b>  |                 |
| <b>Hourly Wind Pressure <math>q_{1/50} \leq 0.75\text{ kPa}</math></b> |   |                        |                        |                         |                 |
| 2.44 (8)   | 15 M @ 1050 (42)                                      | 10 M @ 750 (30)        | 10 M @ 900 (36)        | 10 M @ 1200 (48)        |                 |
| 2.75 (9)   | 15 M @ 750 (30)                                       | 10 M @ 600 (24)        | 10 M @ 750 (30)        | 10 M @ 1200 (48)        |                 |
| 3.05 (10)  | 15 M @ 600 (24)                                       | 15 M @ 1050 (42)       | 10 M @ 600 (24)        | 10 M @ 1200 (48)        |                 |
| 3.66 (12)  | <b>15 M @ 300 (12)</b>                                | <b>15 M @ 750 (30)</b> | <b>15 M @ 900 (36)</b> | <b>10 M @ 1200 (48)</b> |                 |
| 4.27 (14)  | <b>15 M @ 300 (12)</b>                                | <b>15 M @ 450 (18)</b> | <b>15 M @ 750 (30)</b> | <b>10 M @ 750 (30)</b>  |                 |
| 4.88 (16)  | <b>15 M @ 150 (6)</b>                                 | <b>15 M @ 300 (12)</b> | <b>15 M @ 300 (12)</b> | <b>15 M @ 750 (30)</b>  |                 |
| <b>Hourly Wind Pressure <math>q_{1/50} \leq 1.05\text{ kPa}</math></b> |   |                        |                        |                         |                 |
| 2.44 (8)   | 15 M @ 750 (30)                                       | 15 M @ 900 (36)        | 10 M @ 600 (24)        | 10 M @ 1200 (48)        |                 |
| 2.75 (9)   | 15 M @ 600 (24)                                       | 15 M @ 750 (30)        | 15 M @ 1200 (48)       | 10 M @ 1200 (48)        |                 |
| 3.05 (10)  | 15 M @ 450 (18)                                       | 15 M @ 750 (30)        | 15 M @ 750 (30)        | 10 M @ 900 (36)         |                 |
| 3.66 (12)  | <b>15 M @ 300 (12)</b>                                | <b>15 M @ 300 (12)</b> | <b>15 M @ 600 (24)</b> | <b>10 M @ 750 (30)</b>  |                 |
| 4.27 (14)  | <b>15 M @ 150 (6)</b>                                 | <b>15 M @ 300 (12)</b> | <b>15 M @ 300 (12)</b> | <b>15 M @ 900 (36)</b>  |                 |
| 4.88 (16)  |   | <b>15 M @ 150 (6)</b>  | <b>15 M @ 300 (12)</b> | <b>15 M @ 750 (30)</b>  |                 |
| Horizontal   | Block Height of 12" and 18"                           | 10 M @ 900 (36)        | 10 M @ 900 (36)        | 10 M @ 900 (36)         | 10 M @ 900 (36) |
|  | Block Height of 16"                                   | 10 M @ 800 (32)        | 10 M @ 800 (32)        | 10 M @ 800 (32)         | 10 M @ 800 (32) |

NOTES:

1.  $S_{a,ICF}$  is equivalent spectral response acceleration for ICF walls as provided in Appendix A.
2. Provide two layers of the indicated horizontal and vertical distributed steel specified for 300mm (12") walls. Place each layer as shown in the rebar placement drawing.
3. This table is to be used in conjunction with the "Design Limitations."
4. Bolded data indicates reinforcing for ground floor concrete walls only. Second floor concrete walls to be limited in height to 3.0m (10'-0").

# INSULATING CONCRETE FORMS MANUFACTURERS ASSOCIATION



**Table A.1.2. Above Grade Wall Distributed Reinforcement for Seismic Zone Classification,  $S_{a,ICF} \leq 0.16$  and Hourly Wind Pressure,  $q_{1/50} \leq 1.05\text{kPa}$ , for ICF Walls with 8" Tie Spacing**

| Wall Height<br>m (ft)  | Distributed Vertical and Reinforcement (Size and Spacing) |                         |                         |                         |                 |
|--|---|-------------------------|-------------------------|-------------------------|-----------------|
|  | 150 mm (6") 25MPa Wall                                    | 200 mm (8") Wall        | 250 mm (10") Wall       | 300 mm (12") Wall       |                 |
| <b>Hourly Wind Pressure <math>q_{1/50} \leq 0.5\text{ kPa}</math></b>  |   |                         |                         |                         |                 |
| 2.44 (8)   | 10 M @ 600 (24)   | 10 M @ 800 (32)         | 10 M @ 1000 (40)        | 10 M @ 1200 (48)        |                 |
| 2.75 (9)   | 10 M @ 600 (24)   | 10 M @ 800 (32)         | 10 M @ 1000 (40)        | 10 M @ 1200 (48)        |                 |
| 3.05 (10)  | 15 M @ 1000 (40)  | 10 M @ 800 (32)         | 10 M @ 1000 (40)        | 10 M @ 1200 (48)        |                 |
| 3.66 (12)  | <b>15 M @ 800 (32)</b>                                    | <b>15 M @ 1000 (40)</b> | <b>10 M @ 600 (24)</b>  | <b>10 M @ 1200 (48)</b> |                 |
| 4.27 (14)  | <b>15 M @ 400 (16)</b>                                    | <b>15 M @ 800 (32)</b>  | <b>15 M @ 1000 (40)</b> | <b>10 M @ 1200 (48)</b> |                 |
| 4.88 (16)  | <b>15 M @ 400 (16)</b>                                    | <b>15 M @ 600 (24)</b>  | <b>15 M @ 800 (32)</b>  | <b>10 M @ 1000 (40)</b> |                 |
| <b>Hourly Wind Pressure <math>q_{1/50} \leq 0.75\text{ kPa}</math></b> |   |                         |                         |                         |                 |
| 2.44 (8)   | 15 M @ 1200 (48)  | 10 M @ 800 (32)         | 10 M @ 1000 (40)        | 10 M @ 1200 (48)        |                 |
| 2.75 (9)   | 15 M @ 800 (32)   | 10 M @ 600 (24)         | 10 M @ 800 (32)         | 10 M @ 1200 (48)        |                 |
| 3.05 (10)  | 15 M @ 600 (24)   | 15 M @ 1200 (48)        | 10 M @ 600 (24)         | 10 M @ 1200 (48)        |                 |
| 3.66 (12)  | <b>15 M @ 400 (16)</b>                                    | <b>15 M @ 800 (32)</b>  | <b>15 M @ 1000 (40)</b> | <b>10 M @ 1200 (48)</b> |                 |
| 4.27 (14)  | <b>15 M @ 400 (16)</b>                                    | <b>15 M @ 600 (24)</b>  | <b>15 M @ 800 (32)</b>  | <b>10 M @ 800 (32)</b>  |                 |
| 4.88 (16)  | <b>15 M @ 200 (8)</b>                                     | <b>15 M @ 400 (16)</b>  | <b>15 M @ 400 (16)</b>  | <b>15 M @ 800 (32)</b>  |                 |
| <b>Hourly Wind Pressure <math>q_{1/50} \leq 1.05\text{ kPa}</math></b> |   |                         |                         |                         |                 |
| 2.44 (8)   | 15 M @ 800 (32)   | 15 M @ 1000 (40)        | 10 M @ 600 (24)         | 10 M @ 1200 (48)        |                 |
| 2.75 (9)   | 15 M @ 600 (24)   | 15 M @ 800 (32)         | 15 M @ 1200 (48)        | 10 M @ 1200 (48)        |                 |
| 3.05 (10)  | 15 M @ 600 (24)   | 15 M @ 800 (32)         | 15 M @ 800 (32)         | 10 M @ 1000 (40)        |                 |
| 3.66 (12)  | <b>15 M @ 400 (16)</b>                                    | <b>15 M @ 400 (16)</b>  | <b>15 M @ 600 (24)</b>  | <b>10 M @ 800 (32)</b>  |                 |
| 4.27 (14)  | <b>15 M @ 200 (8)</b>                                     | <b>15 M @ 400 (16)</b>  | <b>15 M @ 400 (16)</b>  | <b>15 M @ 1000 (40)</b> |                 |
| 4.88 (16)  |   | <b>15 M @ 200 (8)</b>   | <b>15 M @ 400 (16)</b>  | <b>15 M @ 800 (32)</b>  |                 |
| Horizontal Reinforcement   | Block Height of 12" and 18"                               | 10 M @ 900 (36)         | 10 M @ 900 (36)         | 10 M @ 900 (36)         | 10 M @ 900 (36) |
|  | Block Height of 16"                                       | 10 M @ 800 (32)         | 10 M @ 800 (32)         | 10 M @ 800 (32)         | 10 M @ 800 (32) |

**NOTES:**

1.  $S_{a,ICF}$  is equivalent spectral response acceleration for ICF walls as provided in Appendix A.
2. Provide two layers of the indicated horizontal and vertical distributed steel specified for 300mm (12") walls. Place each layer as shown in the rebar placement drawing.
3. This table is to be used in conjunction with the "Design Limitations."
4. Bolded data indicates reinforcing for ground floor concrete walls only. Second floor concrete walls to be limited in height to 3.0m (10'-0").
5. Alternating vertical bar spacing of 8" o.c. and 16" o.c. may be used to achieve an average spacing of 12" o.c. where 12" o.c. spacing is specified for vertical bars, as shown in Detail A.5.

# INSULATING CONCRETE FORMS MANUFACTURERS ASSOCIATION



**Table A.2.1. Above Grade Wall Distributed Reinforcement for Seismic Zone Classification,  $S_{a,ICF} > 0.16$  and Hourly Wind Pressure,  $q_{1/50} \leq 1.05\text{kPa}$  for, ICF Walls with 6" Tie Spacing**

| Wall Height<br>m (ft)  |                             | Distributed Vertical Reinforcement (Size and Spacing) |                        |                        |                        |
|--|-----------------------------|---|------------------------|------------------------|------------------------|
|  |                             | 150 mm (6") 25MPa Wall                                | 200 mm (8") Wall       | 250 mm (10") Wall      | 300 mm (12") Wall      |
| <b>Seismic zone classification, <math>S_{a,ICF} \leq 0.31</math></b> |                             |   |                        |                        |                        |
| 2.44 (8)   |                             | 10 M @ 300 (12)                                       | 10 M @ 300 (12)        | 10 M @ 300 (12)        | 10 M @ 300 (12)        |
| 2.75 (9)   |                             | 10 M @ 300 (12)                                       | 10 M @ 300 (12)        | 10 M @ 300 (12)        | 10 M @ 300 (12)        |
| 3.05 (10)  |                             | 15 M @ 300 (12)                                       | 10 M @ 300 (12)        | 10 M @ 300 (12)        | 10 M @ 300 (12)        |
| 3.66 (12)  |                             | <b>15 M @ 300 (12)</b>                                | <b>15 M @ 300 (12)</b> | <b>15 M @ 600 (24)</b> | <b>10 M @ 300 (12)</b> |
| 4.27 (14)  |                             | <b>15 M @ 300 (12)</b>                                | <b>15 M @ 300 (12)</b> | <b>15 M @ 300 (12)</b> | <b>10 M @ 300 (12)</b> |
| 4.88 (16)  |                             |   | <b>15 M @ 300 (12)</b> | <b>15 M @ 300 (12)</b> | <b>10 M @ 300 (12)</b> |
| Horizontal Reinforcement   | Block Height of 12" and 18" | 10 M @ 450 (18)                                       | 10 M @ 450 (18)        | 10 M @ 450 (18)        | 10 M @ 450 (18)        |
|  | Block Height of 16"         | 10 M @ 400 (16)                                       | 10 M @ 400 (16)        | 10 M @ 400 (16)        | 10 M @ 400 (16)        |
| <b>Seismic zone classification, <math>S_{a,ICF} \leq 0.53</math></b> |                             |   |                        |                        |                        |
| 2.44 (8)   |                             | 15 M @ 300 (12)                                       | 15 M @ 300 (12)        | 15 M @ 300 (12)        | 10 M @ 300 (12)        |
| 2.75 (9)   |                             | 15 M @ 300 (12)                                       | 15 M @ 300 (12)        | 15 M @ 300 (12)        | 10 M @ 300 (12)        |
| 3.05 (10)  |                             | 15 M @ 300 (12)                                       | 15 M @ 300 (12)        | 15 M @ 300 (12)        | 10 M @ 300 (12)        |
| 3.66 (12)  |                             | <b>15 M @ 300 (12)</b>                                | <b>15 M @ 300 (12)</b> | <b>15 M @ 300 (12)</b> | <b>10 M @ 300 (12)</b> |
| 4.27 (14)  |                             | <b>15 M @ 300 (12)</b>                                | <b>15 M @ 300 (12)</b> | <b>15 M @ 300 (12)</b> | <b>10 M @ 300 (12)</b> |
| 4.88 (16)  |                             |   | <b>15 M @ 300 (12)</b> | <b>15 M @ 300 (12)</b> | <b>10 M @ 300 (12)</b> |
| Horizontal Reinforcement   | Block Height of 12" and 18" | 15 M @ 300 (12)                                       | 15 M @ 300 (12)        | 15 M @ 300 (12)        | 15 M @ 300 (12)        |
|  | Block Height of 16"         | 15 M @ 300 (12)                                       | 15 M @ 300 (12)        | 15 M @ 300 (12)        | 15 M @ 300 (12)        |
| <b>Seismic zone classification, <math>S_{a,ICF} \leq 0.79</math></b> |                             |   |                        |                        |                        |
| 2.44 (8)   |                             | 15 M @ 300 (12)                                       | 15 M @ 300 (12)        | 15 M @ 300 (12)        | 10 M @ 300 (12)        |
| 2.75 (9)   |                             | 15 M @ 300 (12)                                       | 15 M @ 300 (12)        | 15 M @ 300 (12)        | 10 M @ 300 (12)        |
| 3.05 (10)  |                             | 15 M @ 300 (12)                                       | 15 M @ 300 (12)        | 15 M @ 300 (12)        | 10 M @ 300 (12)        |
| 3.66 (12)  |                             | <b>15 M @ 300 (12)</b>                                | <b>15 M @ 300 (12)</b> | <b>15 M @ 300 (12)</b> | <b>10 M @ 300 (12)</b> |
| 4.27 (14)  |                             | <b>15 M @ 300 (12)</b>                                | <b>15 M @ 300 (12)</b> | <b>15 M @ 300 (12)</b> | <b>10 M @ 300 (12)</b> |
| 4.88 (16)  |                             |   | <b>15 M @ 300 (12)</b> | <b>15 M @ 300 (12)</b> | <b>10 M @ 300 (12)</b> |
| Horizontal Reinforcement   | Block Height of 12" and 18" | 15 M @ 300 (12)                                       | 15 M @ 300 (12)        | 15 M @ 300 (12)        | 15 M @ 300 (12)        |
|  | Block Height of 16"         | 15 M @ 300 (12)                                       | 15 M @ 300 (12)        | 15 M @ 300 (12)        | 15 M @ 300 (12)        |

**NOTES:**

1.  $S_{a,ICF}$  is equivalent spectral response acceleration for ICF walls as provided in Appendix A.
2. Provide two layers of the indicated horizontal and vertical distributed steel specified for 300mm (12") walls. Place each layer as shown in the rebar placement drawing.
3. This table is to be used in conjunction with the "Design Limitations."
4. Bolded data indicates reinforcing for ground floor concrete walls only. Second floor concrete walls to be limited in height to 3.0m (10'-0").
5. Alternating horizontal bar spacing of 12" o.c. and 24" o.c. may be used to achieve an average spacing of 18" o.c. where 18" o.c. spacing is specified for horizontal bars, as shown in Detail A.3.
6. Provide 3 horizontal bars in every two rows of 18" high block to achieve an average spacing of 12" o.c. where 12" spacing o.c. is specified for horizontal bars, as shown in Detail A.4.
7. Provide 4 horizontal bars in every three rows of 16" high block to achieve an average spacing of 12" o.c. where 12" spacing o.c. is specified for horizontal bars, as shown in Detail A.5.



**Table A.2.2. Above Grade Wall Distributed Reinforcement for Seismic Zone Classification,  $S_{a,ICF} > 0.16$  and Hourly Wind Pressure,  $q_{1/50} \leq 1.05kPa$  for, ICF Walls with 8" Tie Spacing**

| Wall Height<br>m (ft)  |                             | Distributed Vertical Reinforcement (Size and Spacing) |                        |                        |                        |
|--|-----------------------------|---|------------------------|------------------------|------------------------|
|  |                             | 150 mm (6") 25MPa Wall                                | 200 mm (8") Wall       | 250 mm (10") Wall      | 300 mm (12") Wall      |
| <b>Seismic zone classification, <math>S_{a,ICF} \leq 0.31</math></b> |                             |   |                        |                        |                        |
|  | 2.44 (8)                    | 10 M @ 300 (12)                                       | 10 M @ 300 (12)        | 10 M @ 300 (12)        | 10 M @ 400 (16)        |
|  | 2.75 (9)                    | 10 M @ 300 (12)                                       | 10 M @ 300 (12)        | 10 M @ 300 (12)        | 10 M @ 400 (16)        |
|  | 3.05 (10)                   | 15 M @ 400 (16)                                       | 10 M @ 300 (12)        | 10 M @ 300 (12)        | 10 M @ 400 (16)        |
|  | 3.66 (12)                   | <b>15 M @ 300 (12)</b>                                | <b>15 M @ 400 (16)</b> | <b>15 M @ 600 (24)</b> | <b>10 M @ 400 (16)</b> |
|  | 4.27 (14)                   | <b>15 M @ 300 (12)</b>                                | <b>15 M @ 400 (16)</b> | <b>15 M @ 400 (16)</b> | <b>10 M @ 400 (16)</b> |
|  | 4.88 (16)                   |   | <b>15 M @ 300 (12)</b> | <b>15 M @ 300 (12)</b> | <b>10 M @ 400 (16)</b> |
| Horizontal Reinforcement   | Block Height of 12" and 18" | 10 M @ 450 (18)                                       | 10 M @ 450 (18)        | 10 M @ 450 (18)        | 10 M @ 450 (18)        |
|  | Block Height of 16"         | 10 M @ 400 (16)                                       | 10 M @ 400 (16)        | 10 M @ 400 (16)        | 10 M @ 400 (16)        |
| <b>Seismic zone classification, <math>S_{a,ICF} \leq 0.53</math></b> |                             |   |                        |                        |                        |
|  | 2.44 (8)                    | 15 M @ 300 (12)                                       | 15 M @ 400 (16)        | 15 M @ 400 (16)        | 10 M @ 300 (12)        |
|  | 2.75 (9)                    | 15 M @ 300 (12)                                       | 15 M @ 400 (16)        | 15 M @ 400 (16)        | 10 M @ 300 (12)        |
|  | 3.05 (10)                   | 15 M @ 300 (12)                                       | 15 M @ 400 (16)        | 15 M @ 400 (16)        | 10 M @ 300 (12)        |
|  | 3.66 (12)                   | <b>15 M @ 300 (12)</b>                                | <b>15 M @ 400 (16)</b> | <b>15 M @ 400 (16)</b> | <b>10 M @ 300 (12)</b> |
|  | 4.27 (14)                   | <b>15 M @ 300 (12)</b>                                | <b>15 M @ 400 (16)</b> | <b>15 M @ 400 (16)</b> | <b>10 M @ 300 (12)</b> |
|  | 4.88 (16)                   |   | <b>15 M @ 300 (12)</b> | <b>15 M @ 400 (16)</b> | <b>10 M @ 300 (12)</b> |
| Horizontal Reinforcement   | Block Height of 12" and 18" | 15 M @ 300 (12)                                       | 15 M @ 300 (12)        | 15 M @ 300 (12)        | 15 M @ 300 (12)        |
|  | Block Height of 16"         | 15 M @ 300 (12)                                       | 15 M @ 300 (12)        | 15 M @ 300 (12)        | 15 M @ 300 (12)        |
| <b>Seismic zone classification, <math>S_{a,ICF} \leq 0.79</math></b> |                             |   |                        |                        |                        |
|  | 2.44 (8)                    | 15 M @ 300 (12)                                       | 15 M @ 300 (12)        | 15 M @ 300 (12)        | 10 M @ 300 (12)        |
|  | 2.75 (9)                    | 15 M @ 300 (12)                                       | 15 M @ 300 (12)        | 15 M @ 300 (12)        | 10 M @ 300 (12)        |
|  | 3.05 (10)                   | 15 M @ 300 (12)                                       | 15 M @ 300 (12)        | 15 M @ 300 (12)        | 10 M @ 300 (12)        |
|  | 3.66 (12)                   | <b>15 M @ 300 (12)</b>                                | <b>15 M @ 300 (12)</b> | <b>15 M @ 300 (12)</b> | <b>10 M @ 300 (12)</b> |
|  | 4.27 (14)                   | <b>15 M @ 300 (12)</b>                                | <b>15 M @ 300 (12)</b> | <b>15 M @ 300 (12)</b> | <b>10 M @ 300 (12)</b> |
|  | 4.88 (16)                   |   | <b>15 M @ 300 (12)</b> | <b>15 M @ 300 (12)</b> | <b>10 M @ 300 (12)</b> |
| Horizontal Reinforcement   | Block Height of 12" and 18" | 15 M @ 300 (12)                                       | 15 M @ 300 (12)        | 15 M @ 300 (12)        | 15 M @ 300 (12)        |
|  | Block Height of 16"         | 15 M @ 300 (12)                                       | 15 M @ 300 (12)        | 15 M @ 300 (12)        | 15 M @ 300 (12)        |

**NOTES:**

1.  $S_{a,ICF}$  is equivalent spectral response acceleration for ICF walls as provided in Appendix A.
2. Provide two layers of the indicated horizontal and vertical distributed steel specified for 300mm (12") walls. Place each layer as shown in the rebar placement drawing.
3. This table is to be used in conjunction with the "Design Limitations."
4. Bolded data indicates reinforcing for ground floor concrete walls only. Second floor concrete walls to be limited in height to 3.0m (10'-0").
5. Alternating horizontal bar spacing of 12" o.c. and 24" o.c. may be used to achieve an average spacing of 18" o.c. where 18" o.c. spacing is specified for horizontal bars, as shown in Detail A.3.
6. Provide 3 horizontal bars in every two rows of 18" high block to achieve an average spacing of 12" o.c. where 12" spacing o.c. is specified for horizontal bars, as shown in Detail A.4.
7. Provide 4 horizontal bars in every three rows of 16" high block to achieve an average spacing of 12" o.c. where 12" spacing o.c. is specified for horizontal bars, as shown in Detail A.5.
8. Alternating vertical bar spacing of 8" o.c. and 16" o.c. may be used to achieve an average spacing of 12" o.c. where 12" o.c. spacing is specified for vertical bars, as shown in Detail A.6.



**Table A.3.3200. Above Grade Shear Wall Length for Seismic Zone Classification,  $S_{a,ICF} \leq 0.16$  and Hourly Wind Pressure,  $q_{1/50} \leq 0.5kPa$  (in a Building Without Walkout Basement), where Building Area  $\leq 3200ft^2$**

| Wall Height m (ft)   | Seismic Zone Classification               |                     |                       |            |                       |                     |                      |           |           |                     |            |           |            |            |           |
|--|---|---------------------|-----------------------|------------|-----------------------|---------------------|----------------------|-----------|-----------|---------------------|------------|-----------|------------|------------|-----------|
|  | $S_{a,ICF} \leq 0.07$                     |                     | $S_{a,ICF} \leq 0.11$ |            | $S_{a,ICF} \leq 0.16$ |                     |                      |           |           |                     |            |           |            |            |           |
| <b>Second Floor Walls of Two Story ICF Structure Supporting Wood Frame Roof (TYPE A)</b>                       |   |                     |                       |            |                       |                     |                      |           |           |                     |            |           |            |            |           |
|  | 6" & 8" Thick Wall                        |                     | 10" & 12" Thick Wall  |            | 6" & 8" Thick Wall    |                     | 10" & 12" Thick Wall |           |           |                     |            |           |            |            |           |
|  | Number and length of shear walls provided |                     |                       |            |                       |                     |                      |           |           |                     |            |           |            |            |           |
| 2.44 (8)   | 1 x 8'-0"                                 | 2 x 4'-0"           | 3 x 2'-8"             | 1 x 8'-0"  | 2 x 4'-0"             | 3 x 2'-8"           | 1 x 8'-0"            | 2 x 4'-0" | 3 x 3'-0" | 1 x 8'-0"           | 2 x 4'-0"  | 3 x 3'-0" | 1 x 8'-0"  | 2 x 4'-0"  | 3 x 3'-0" |
| 2.75 (9)   | 1 x 8'-0"                                 | 2 x 4'-0"           | 3 x 2'-8"             | 1 x 8'-0"  | 2 x 4'-0"             | 3 x 2'-8"           | 1 x 8'-0"            | 2 x 4'-0" | 3 x 3'-0" | 1 x 8'-0"           | 2 x 4'-0"  | 3 x 3'-0" | 1 x 8'-0"  | 2 x 4'-6"  | 3 x 3'-6" |
| 3.05 (10)  | 1 x 8'-0"                                 | 2 x 4'-0"           | 3 x 2'-8"             | 1 x 8'-0"  | 2 x 4'-0"             | 3 x 2'-8"           | 1 x 8'-0"            | 2 x 4'-0" | 3 x 3'-0" | 1 x 8'-0"           | 2 x 4'-0"  | 3 x 3'-0" | 1 x 8'-0"  | 2 x 5'-0"  | 3 x 3'-6" |
| <b>Main Floor Walls of One Story ICF Structure Supporting Wood Frame Roof (TYPE B)</b>                         |   |                     |                       |            |                       |                     |                      |           |           |                     |            |           |            |            |           |
|  | 6" & 8" Thick Wall                        |                     | 10" & 12" Thick Wall  |            | 6" & 8" Thick Wall    |                     | 10" & 12" Thick Wall |           |           |                     |            |           |            |            |           |
|  | Number and length of shear walls provided |                     |                       |            |                       |                     |                      |           |           |                     |            |           |            |            |           |
| 2.44 (8)   | 1 x 8'-0"                                 | 2 x 4'-0"           | 3 x 2'-8"             | 1 x 8'-0"  | 2 x 4'-0"             | 3 x 2'-8"           | 1 x 8'-0"            | 2 x 4'-0" | 3 x 3'-0" | 1 x 8'-0"           | 2 x 4'-0"  | 3 x 3'-0" | 1 x 8'-0"  | 2 x 4'-0"  | 3 x 3'-0" |
| 2.75 (9)   | 1 x 8'-0"                                 | 2 x 4'-0"           | 3 x 2'-8"             | 1 x 8'-0"  | 2 x 4'-0"             | 3 x 2'-8"           | 1 x 8'-0"            | 2 x 4'-0" | 3 x 3'-0" | 1 x 8'-0"           | 2 x 4'-0"  | 3 x 3'-0" | 1 x 8'-0"  | 2 x 4'-6"  | 3 x 3'-6" |
| 3.05 (10)  | 1 x 8'-0"                                 | 2 x 4'-0"           | 3 x 2'-8"             | 1 x 8'-0"  | 2 x 4'-0"             | 3 x 2'-8"           | 1 x 8'-0"            | 2 x 4'-0" | 3 x 3'-0" | 1 x 8'-0"           | 2 x 4'-0"  | 3 x 3'-0" | 1 x 8'-0"  | 2 x 5'-0"  | 3 x 3'-6" |
| 3.66 (12)  | 1 x 8'-0"                                 | 2 x 4'-0"           | 3 x 3'-0"             | 1 x 8'-0"  | 2 x 4'-0"             | 3 x 3'-0"           | 1 x 8'-0"            | 2 x 4'-6" | 3 x 3'-6" | 1 x 8'-0"           | 2 x 4'-6"  | 3 x 3'-6" | 1 x 9'-0"  | 2 x 5'-6"  | 3 x 4'-6" |
| 4.27 (14)  | 1 x 8'-0"                                 | 2 x 4'-0"           | 3 x 3'-0"             | 1 x 8'-0"  | 2 x 4'-0"             | 3 x 3'-0"           | 1 x 8'-0"            | 2 x 5'-0" | 3 x 4'-0" | 1 x 8'-0"           | 2 x 5'-0"  | 3 x 4'-0" | 1 x 9'-4"  | 2 x 6'-0"  | 3 x 5'-0" |
| 4.88 (16)  | 1 x 8'-0"                                 | 2 x 4'-0"           | 3 x 3'-0"             | 1 x 8'-0"  | 2 x 5'-0"             | 3 x 4'-0"           | 1 x 8'-0"            | 2 x 5'-0" | 3 x 4'-0" | 1 x 9'-0"           | 2 x 6'-0"  | 3 x 4'-6" | 1 x 10'-0" | 2 x 7'-0"  | 3 x 5'-6" |
| <b>Main Floor Walls of Two Story Structure Supporting 2nd Story Wood Framed Walls, Floor and Roof (TYPE C)</b> |   |                     |                       |            |                       |                     |                      |           |           |                     |            |           |            |            |           |
|  | 6" & 8" Thick Wall                        |                     | 10" & 12" Thick Wall  |            | 6" & 8" Thick Wall    |                     | 10" & 12" Thick Wall |           |           |                     |            |           |            |            |           |
|  | Number and length of shear walls provided |                     |                       |            |                       |                     |                      |           |           |                     |            |           |            |            |           |
| 2.44 (8)   | 1 x 8'-0"                                 | 2 x 4'-0"           | 3 x 3'-0"             | 1 x 8'-0"  | 2 x 4'-0"             | 3 x 3'-0"           | 1 x 9'-0"            | 2 x 6'-0" | 3 x 5'-0" | 1 x 9'-0"           | 2 x 6'-6"  | 3 x 5'-0" | 1 x 11'-0" | 2 x 7'-0"  | 3 x 5'-6" |
| 2.75 (9)   | 1 x 8'-0"                                 | 2 x 4'-6"           | 3 x 3'-6"             | 1 x 8'-0"  | 2 x 4'-6"             | 3 x 3'-6"           | 1 x 9'-0"            | 2 x 6'-6" | 3 x 5'-0" | 1 x 10'-0"          | 2 x 7'-0"  | 3 x 5'-0" | 1 x 12'-0" | 2 x 7'-6"  | 3 x 6'-0" |
| 3.05 (10)  | 1 x 8'-0"                                 | 2 x 5'-0"           | 3 x 4'-0"             | 1 x 8'-0"  | 2 x 5'-0"             | 3 x 4'-0"           | 1 x 9'-6"            | 2 x 7'-4" | 3 x 6'-0" | 1 x 10'-0"          | 2 x 7'-4"  | 3 x 6'-0" | 1 x 12'-0" | 2 x 8'-0"  | 3 x 6'-6" |
| 3.66 (12)  | 1 x 8'-6"                                 | 2 x 5'-6"           | 3 x 4'-0"             | 1 x 8'-6"  | 2 x 5'-6"             | 3 x 4'-0"           | 1 x 10'-6"           | 2 x 8'-4" | 3 x 6'-6" | 1 x 10'-6"          | 2 x 8'-4"  | 3 x 6'-6" | 1 x 13'-0" | 2 x 9'-0"  | 3 x 7'-0" |
| 4.27 (14)  | 1 x 8'-6"                                 | 2 x 5'-6"           | 3 x 4'-6"             | 1 x 8'-6"  | 2 x 6'-0"             | 3 x 4'-6"           | 1 x 11'-0"           | 2 x 8'-6" | 3 x 7'-0" | 1 x 11'-6"          | 2 x 9'-0"  | 3 x 7'-0" | 1 x 13'-0" | 2 x 9'-0"  | 3 x 7'-6" |
| 4.88 (16)  | 1 x 8'-6"                                 | 2 x 5'-6"           | 3 x 4'-6"             | 1 x 9'-0"  | 2 x 6'-0"             | 3 x 5'-0"           | 1 x 11'-0"           | 2 x 9'-0" | 3 x 7'-6" | 1 x 12'-0"          | 2 x 9'-6"  | 3 x 7'-6" | 1 x 13'-0" | 2 x 9'-0"  | 3 x 7'-6" |
| <b>Main Floor Walls of Two Story ICF Structure Supporting Wood Frame Floors and Roof (TYPE D)</b>              |   |                     |                       |            |                       |                     |                      |           |           |                     |            |           |            |            |           |
|  | 6" & 8" Thick Wall                        |                     | 10" & 12" Thick Wall  |            | 6" & 8" Thick Wall    |                     | 10" & 12" Thick Wall |           |           |                     |            |           |            |            |           |
|  | Number and length of shear walls provided |                     |                       |            |                       |                     |                      |           |           |                     |            |           |            |            |           |
| 2.44 (8)   | 1 x 9'-0"                                 | 2 x 5'-6"           | 3 x 4'-0"             | 1 x 9'-0"  | 2 x 5'-6"             | 3 x 4'-6"           | 1 x 11'-0"           | 2 x 7'-0" | 3 x 5'-6" | 1 x 12'-0"          | 2 x 8'-0"  | 3 x 6'-0" | 1 x 14'-0" | 2 x 9'-0"  | 3 x 7'-0" |
| 2.75 (9)   | 1 x 9'-0"                                 | 2 x 6'-0"           | 3 x 4'-0"             | 1 x 10'-0" | 2 x 6'-0"             | 3 x 5'-0"           | 1 x 12'-0"           | 2 x 7'-6" | 3 x 6'-0" | 1 x 13'-0"          | 2 x 8'-0"  | 3 x 6'-0" | 1 x 15'-0" | 2 x 9'-6"  | 3 x 8'-0" |
| 3.05 (10)  | 1 x 9'-6"                                 | 2 x 6'-0"           | 3 x 4'-6"             | 1 x 10'-0" | 2 x 6'-6"             | 3 x 5'-0"           | 1 x 13'-0"           | 2 x 8'-0" | 3 x 6'-0" | 1 x 13'-0"          | 2 x 8'-6"  | 3 x 7'-0" | 1 x 15'-6" | 2 x 10'-0" | 3 x 8'-0" |
| 3.66 (12)  | 1 x 10'-0"                                | 2 x 7'-0"           | 3 x 5'-0"             | 1 x 10'-0" | 2 x 7'-0"             | 3 x 5'-0"           | 1 x 13'-6"           | 2 x 9'-0" | 3 x 7'-0" | 1 x 13'-6"          | 2 x 9'-0"  | 3 x 7'-0" | 1 x 16'-0" | 2 x 11'-0" | 3 x 9'-0" |
| 4.27 (14)  | 1 x 10'-0"                                | 2 x 7'-0"           | 3 x 5'-6"             | 1 x 11'-0" | 2 x 7'-6"             | 3 x 6'-0"           | 1 x 13'-0"           | 2 x 9'-0" | 3 x 7'-0" | 1 x 14'-6"          | 2 x 9'-6"  | 3 x 8'-0" | 1 x 16'-0" | 2 x 11'-0" | 3 x 9'-0" |
| 4.88 (16)  | 1 x 10'-0"                                | 2 x 7'-0"           | 3 x 5'-6"             | 1 x 11'-6" | 2 x 7'-6"             | 3 x 6'-0"           | 1 x 13'-0"           | 2 x 9'-0" | 3 x 7'-0" | 1 x 14'-6"          | 2 x 10'-0" | 3 x 8'-0" | 1 x 16'-0" | 2 x 11'-0" | 3 x 9'-0" |
| Vertical Reinforcement   | ICF with 6" Tie Spacing                   | As per table A.1.1. |                       |            |                       | As per table A.1.1. |                      |           |           | As per table A.1.1. |            |           |            |            |           |
| Vertical Reinforcement   | ICF with 8" Tie Spacing                   | As per table A.1.2. |                       |            |                       | As per table A.1.2. |                      |           |           | As per table A.1.2. |            |           |            |            |           |
| Horizontal Reinforcement   | Block Height of 12" and 18"               | 10 M @ 450 (18)     |                       |            |                       | 10 M @ 450 (18)     |                      |           |           | 10 M @ 450 (18)     |            |           |            |            |           |
| Horizontal Reinforcement   | Block Height of 16"                       | 10 M @ 400 (16)     |                       |            |                       | 10 M @ 400 (16)     |                      |           |           | 10 M @ 400 (16)     |            |           |            |            |           |

**NOTES:**

- $S_{a,ICF}$  is equivalent spectral response acceleration for ICF walls as provided in Appendix A.
- This table is to be used in conjunction with the "Design Limitations."
- Provide two layers of the indicated horizontal and vertical distributed steel specified for 300mm (12") walls. Place each layer as shown in the rebar placement drawing.
- All four sides of the building are to have a minimum number and length of shear walls that conforms to this table.
- Use Table A.6 for buildings that do not meet the required wall length of this table.
- Provide 2-15M concentrated reinforcement at each end of shear walls as shown in shear wall detail.
- All concentrated reinforcement is to be continued to the bottom of the foundation wall. Provide lap splices as required.
- Concentrated reinforcement is to be placed in accordance with Bar Placement Detail.

**INSULATING CONCRETE FORMS MANUFACTURERS ASSOCIATION**



**Table A.4.3200. Above Grade Shear Wall Length for Seismic Zone Classification,  $S_{a,ICF} \leq 0.16$  and Hourly Wind Pressure,  $0.5kPa < q_{1/50} \leq 0.75kPa$  (in a Building Without Walkout Basement), where Building Area  $\leq 3200ft^2$**

| Wall Height m (ft)   | Seismic Zone Classification               |           |                       |                     |                       |           |                      |           |           |                     |            |           |            |            |           |            |            |            |
|--|---|-----------|-----------------------|---------------------|-----------------------|-----------|----------------------|-----------|-----------|---------------------|------------|-----------|------------|------------|-----------|------------|------------|------------|
|  | $S_{a,ICF} \leq 0.07$                     |           | $S_{a,ICF} \leq 0.11$ |                     | $S_{a,ICF} \leq 0.16$ |           |                      |           |           |                     |            |           |            |            |           |            |            |            |
| <b>Second Floor Walls of Two Story ICF Structure Supporting Wood Frame Roof (TYPE A)</b>                       |   |           |                       |                     |                       |           |                      |           |           |                     |            |           |            |            |           |            |            |            |
|  | 6" & 8" Thick Wall                        |           | 10" & 12" Thick Wall  |                     | 6" & 8" Thick Wall    |           | 10" & 12" Thick Wall |           |           |                     |            |           |            |            |           |            |            |            |
|  | Number and length of shear walls provided |           |                       |                     |                       |           |                      |           |           |                     |            |           |            |            |           |            |            |            |
| 2.44 (8)   | 1 x 8'-0"                                 | 2 x 4'-0" | 3 x 2'-8"             | 1 x 8'-0"           | 2 x 4'-0"             | 3 x 2'-8" | 1 x 8'-0"            | 2 x 4'-0" | 3 x 3'-0" | 1 x 8'-0"           | 2 x 4'-0"  | 3 x 3'-0" | 1 x 8'-0"  | 2 x 4'-0"  | 3 x 3'-0" |            |            |            |
| 2.75 (9)   | 1 x 8'-0"                                 | 2 x 4'-0" | 3 x 2'-8"             | 1 x 8'-0"           | 2 x 4'-0"             | 3 x 2'-8" | 1 x 8'-0"            | 2 x 4'-0" | 3 x 3'-0" | 1 x 8'-0"           | 2 x 4'-0"  | 3 x 3'-0" | 1 x 8'-0"  | 2 x 4'-0"  | 3 x 3'-0" |            |            |            |
| 3.05 (10)  | 1 x 8'-0"                                 | 2 x 4'-0" | 3 x 2'-8"             | 1 x 8'-0"           | 2 x 4'-0"             | 3 x 2'-8" | 1 x 8'-0"            | 2 x 4'-0" | 3 x 3'-0" | 1 x 8'-0"           | 2 x 4'-0"  | 3 x 3'-0" | 1 x 8'-0"  | 2 x 4'-0"  | 3 x 3'-0" |            |            |            |
| 4.27 (14)  | 1 x 8'-0"                                 | 2 x 4'-0" | 3 x 2'-8"             | 1 x 8'-0"           | 2 x 4'-0"             | 3 x 2'-8" | 1 x 8'-0"            | 2 x 4'-0" | 3 x 3'-0" | 1 x 8'-0"           | 2 x 4'-0"  | 3 x 3'-0" | 1 x 8'-0"  | 2 x 4'-0"  | 3 x 3'-0" |            |            |            |
| 4.88 (16)  | 1 x 8'-0"                                 | 2 x 4'-0" | 3 x 2'-8"             | 1 x 8'-0"           | 2 x 4'-0"             | 3 x 2'-8" | 1 x 8'-0"            | 2 x 4'-0" | 3 x 3'-0" | 1 x 8'-0"           | 2 x 4'-0"  | 3 x 3'-0" | 1 x 8'-0"  | 2 x 4'-0"  | 3 x 3'-0" |            |            |            |
| <b>Main Floor Walls of One Story ICF Structure Supporting Wood Frame Roof (TYPE B)</b>                         |   |           |                       |                     |                       |           |                      |           |           |                     |            |           |            |            |           |            |            |            |
|  | 6" & 8" Thick Wall                        |           | 10" & 12" Thick Wall  |                     | 6" & 8" Thick Wall    |           | 10" & 12" Thick Wall |           |           |                     |            |           |            |            |           |            |            |            |
|  | Number and length of shear walls provided |           |                       |                     |                       |           |                      |           |           |                     |            |           |            |            |           |            |            |            |
| 2.44 (8)   | 1 x 8'-0"                                 | 2 x 4'-0" | 3 x 2'-8"             | 1 x 8'-0"           | 2 x 4'-0"             | 3 x 2'-8" | 1 x 8'-0"            | 2 x 4'-0" | 3 x 3'-0" | 1 x 8'-0"           | 2 x 4'-0"  | 3 x 3'-0" | 1 x 8'-0"  | 2 x 4'-0"  | 3 x 3'-0" |            |            |            |
| 2.75 (9)   | 1 x 8'-0"                                 | 2 x 4'-0" | 3 x 2'-8"             | 1 x 8'-0"           | 2 x 4'-0"             | 3 x 2'-8" | 1 x 8'-0"            | 2 x 4'-0" | 3 x 3'-0" | 1 x 8'-0"           | 2 x 4'-0"  | 3 x 3'-0" | 1 x 8'-0"  | 2 x 4'-0"  | 3 x 3'-0" |            |            |            |
| 3.05 (10)  | 1 x 8'-0"                                 | 2 x 4'-0" | 3 x 2'-8"             | 1 x 8'-0"           | 2 x 4'-0"             | 3 x 2'-8" | 1 x 8'-0"            | 2 x 4'-0" | 3 x 3'-0" | 1 x 8'-0"           | 2 x 4'-0"  | 3 x 3'-0" | 1 x 8'-0"  | 2 x 4'-0"  | 3 x 3'-0" |            |            |            |
| 3.66 (12)  | 1 x 8'-0"                                 | 2 x 4'-0" | 3 x 3'-0"             | 1 x 8'-0"           | 2 x 4'-0"             | 3 x 3'-0" | 1 x 8'-0"            | 2 x 4'-0" | 3 x 3'-0" | 1 x 8'-0"           | 2 x 4'-0"  | 3 x 3'-0" | 1 x 8'-0"  | 2 x 4'-0"  | 3 x 3'-0" |            |            |            |
| 4.27 (14)  | 1 x 8'-0"                                 | 2 x 4'-0" | 3 x 3'-0"             | 1 x 8'-0"           | 2 x 4'-0"             | 3 x 3'-0" | 1 x 8'-0"            | 2 x 4'-0" | 3 x 3'-0" | 1 x 8'-0"           | 2 x 4'-0"  | 3 x 3'-0" | 1 x 8'-0"  | 2 x 4'-0"  | 3 x 3'-0" |            |            |            |
| 4.88 (16)  | 1 x 8'-0"                                 | 2 x 4'-0" | 3 x 3'-0"             | 1 x 8'-0"           | 2 x 4'-0"             | 3 x 3'-0" | 1 x 8'-0"            | 2 x 4'-0" | 3 x 3'-0" | 1 x 8'-0"           | 2 x 4'-0"  | 3 x 3'-0" | 1 x 8'-0"  | 2 x 4'-0"  | 3 x 3'-0" |            |            |            |
| <b>Main Floor Walls of Two Story Structure Supporting 2nd Story Wood Framed Walls, Floor and Roof (TYPE C)</b> |   |           |                       |                     |                       |           |                      |           |           |                     |            |           |            |            |           |            |            |            |
|  | 6" & 8" Thick Wall                        |           | 10" & 12" Thick Wall  |                     | 6" & 8" Thick Wall    |           | 10" & 12" Thick Wall |           |           |                     |            |           |            |            |           |            |            |            |
|  | Number and length of shear walls provided |           |                       |                     |                       |           |                      |           |           |                     |            |           |            |            |           |            |            |            |
| 2.44 (8)   | 1 x 8'-0"                                 | 2 x 4'-6" | 3 x 3'-6"             | 1 x 8'-0"           | 2 x 4'-0"             | 3 x 3'-0" | 1 x 9'-0"            | 2 x 6'-0" | 3 x 5'-0" | 1 x 9'-0"           | 2 x 6'-6"  | 3 x 5'-0" | 1 x 11'-6" | 2 x 7'-6"  | 3 x 6'-0" | 1 x 11'-6" | 2 x 7'-0"  | 3 x 5'-6"  |
| 2.75 (9)   | 1 x 8'-0"                                 | 2 x 4'-6" | 3 x 3'-6"             | 1 x 8'-0"           | 2 x 4'-6"             | 3 x 3'-6" | 1 x 9'-0"            | 2 x 6'-6" | 3 x 5'-0" | 1 x 10'-0"          | 2 x 7'-0"  | 3 x 5'-0" | 1 x 12'-0" | 2 x 7'-6"  | 3 x 6'-0" | 1 x 12'-0" | 2 x 7'-6"  | 3 x 6'-0"  |
| 3.05 (10)  | 1 x 8'-0"                                 | 2 x 5'-0" | 3 x 4'-0"             | 1 x 8'-0"           | 2 x 5'-0"             | 3 x 4'-0" | 1 x 10'-0"           | 2 x 7'-4" | 3 x 6'-0" | 1 x 10'-0"          | 2 x 7'-4"  | 3 x 6'-0" | 1 x 12'-6" | 2 x 8'-6"  | 3 x 6'-6" | 1 x 12'-6" | 2 x 8'-0"  | 3 x 6'-6"  |
| 3.66 (12)  | 1 x 8'-6"                                 | 2 x 5'-6" | 3 x 4'-0"             | 1 x 8'-6"           | 2 x 5'-6"             | 3 x 4'-0" | 1 x 10'-6"           | 2 x 8'-4" | 3 x 6'-6" | 1 x 10'-6"          | 2 x 8'-4"  | 3 x 6'-6" | 1 x 13'-0" | 2 x 9'-0"  | 3 x 7'-0" | 1 x 13'-0" | 2 x 9'-0"  | 3 x 7'-0"  |
| 4.27 (14)  | 1 x 8'-6"                                 | 2 x 5'-6" | 3 x 4'-6"             | 1 x 8'-6"           | 2 x 6'-0"             | 3 x 4'-6" | 1 x 11'-0"           | 2 x 8'-6" | 3 x 7'-0" | 1 x 11'-6"          | 2 x 9'-0"  | 3 x 7'-0" | 1 x 13'-0" | 2 x 9'-0"  | 3 x 7'-0" | 1 x 14'-0" | 2 x 10'-0" | 3 x 7'-6"  |
| 4.88 (16)  | 1 x 8'-6"                                 | 2 x 5'-6" | 3 x 4'-6"             | 1 x 9'-0"           | 2 x 6'-0"             | 3 x 5'-0" | 1 x 11'-0"           | 2 x 9'-0" | 3 x 7'-6" | 1 x 12'-0"          | 2 x 9'-6"  | 3 x 7'-6" | 1 x 13'-0" | 2 x 9'-0"  | 3 x 7'-6" | 1 x 14'-6" | 2 x 10'-0" | 3 x 7'-6"  |
| <b>Main Floor Walls of Two Story ICF Structure Supporting Wood Frame Floors and Roof (TYPE D)</b>              |   |           |                       |                     |                       |           |                      |           |           |                     |            |           |            |            |           |            |            |            |
|  | 6" & 8" Thick Wall                        |           | 10" & 12" Thick Wall  |                     | 6" & 8" Thick Wall    |           | 10" & 12" Thick Wall |           |           |                     |            |           |            |            |           |            |            |            |
|  | Number and length of shear walls provided |           |                       |                     |                       |           |                      |           |           |                     |            |           |            |            |           |            |            |            |
| 2.44 (8)   | 1 x 9'-0"                                 | 2 x 5'-6" | 3 x 4'-6"             | 1 x 9'-0"           | 2 x 5'-6"             | 3 x 4'-6" | 1 x 11'-0"           | 2 x 7'-0" | 3 x 5'-6" | 1 x 12'-0"          | 2 x 8'-0"  | 3 x 6'-0" | 1 x 14'-0" | 2 x 9'-0"  | 3 x 7'-0" | 1 x 16'-0" | 2 x 10'-0" | 3 x 8'-0"  |
| 2.75 (9)   | 1 x 9'-0"                                 | 2 x 6'-0" | 3 x 4'-6"             | 1 x 10'-0"          | 2 x 6'-0"             | 3 x 5'-0" | 1 x 12'-0"           | 2 x 7'-6" | 3 x 6'-0" | 1 x 13'-0"          | 2 x 8'-0"  | 3 x 6'-0" | 1 x 15'-0" | 2 x 9'-6"  | 3 x 8'-0" | 1 x 16'-0" | 2 x 11'-0" | 3 x 8'-0"  |
| 3.05 (10)  | 1 x 9'-6"                                 | 2 x 6'-6" | 3 x 5'-0"             | 1 x 10'-0"          | 2 x 6'-6"             | 3 x 5'-0" | 1 x 13'-0"           | 2 x 8'-6" | 3 x 6'-6" | 1 x 13'-0"          | 2 x 8'-6"  | 3 x 7'-0" | 1 x 15'-6" | 2 x 10'-6" | 3 x 8'-0" | 1 x 17'-0" | 2 x 11'-0" | 3 x 8'-6"  |
| 3.66 (12)  | 1 x 10'-0"                                | 2 x 7'-0" | 3 x 5'-0"             | 1 x 10'-6"          | 2 x 7'-0"             | 3 x 5'-6" | 1 x 13'-0"           | 2 x 9'-0" | 3 x 7'-0" | 1 x 13'-6"          | 2 x 9'-0"  | 3 x 7'-0" | 1 x 16'-0" | 2 x 11'-0" | 3 x 9'-0" | 1 x 17'-0" | 2 x 11'-0" | 3 x 9'-0"  |
| 4.27 (14)  | 1 x 10'-0"                                | 2 x 7'-0" | 3 x 5'-6"             | 1 x 11'-0"          | 2 x 7'-6"             | 3 x 6'-0" | 1 x 13'-0"           | 2 x 9'-0" | 3 x 7'-0" | 1 x 14'-6"          | 2 x 9'-6"  | 3 x 8'-0" | 1 x 16'-0" | 2 x 11'-0" | 3 x 9'-0" | 1 x 18'-0" | 2 x 12'-0" | 3 x 10'-0" |
| 4.88 (16)  | 1 x 10'-0"                                | 2 x 7'-0" | 3 x 5'-6"             | 1 x 11'-6"          | 2 x 7'-6"             | 3 x 6'-0" | 1 x 13'-0"           | 2 x 9'-0" | 3 x 7'-0" | 1 x 14'-6"          | 2 x 10'-0" | 3 x 8'-0" | 1 x 16'-0" | 2 x 11'-0" | 3 x 9'-0" | 1 x 18'-0" | 2 x 12'-6" | 3 x 10'-0" |
| Vertical Reinforcement   | ICF with 6" Tie Spacing                   |           |                       | As per table A.1.1. |                       |           | As per table A.1.1.  |           |           | As per table A.1.1. |            |           |            |            |           |            |            |            |
| Vertical Reinforcement   | ICF with 8" Tie Spacing                   |           |                       | As per table A.1.2. |                       |           | As per table A.1.2.  |           |           | As per table A.1.2. |            |           |            |            |           |            |            |            |
| Horizontal Reinforcement   | Block Height of 12" and 18"               |           |                       | 10 M @ 450 (18)     |                       |           | 10 M @ 450 (18)      |           |           | 10 M @ 450 (18)     |            |           |            |            |           |            |            |            |
| Horizontal Reinforcement   | Block Height of 16"                       |           |                       | 10 M @ 400 (16)     |                       |           | 10 M @ 400 (16)      |           |           | 10 M @ 400 (16)     |            |           |            |            |           |            |            |            |

**NOTES:**

1.  $S_{a,ICF}$  is equivalent spectral response acceleration for ICF walls as provided in Appendix A.
2. This table is to be used in conjunction with the "Design Limitations."
3. Provide two layers of the indicated horizontal and vertical distributed steel specified for 300mm (12") walls. Place each layer as shown in the rebar placement drawing.
4. All four sides of the building are to have a minimum number and length of shear walls that conforms to this table.
5. Use Table A.6 for buildings that do not meet the required wall length of this table.
6. Provide 2-15M concentrated reinforcement at each end of shear walls as shown in shear wall detail.
7. All concentrated reinforcement is to be continues to the bottom of the foundation wall. Provide lap splices as required.
8. Concentrated reinforcement is to be placed in accordance with Bar Placement Detail.

INSULATING CONCRETE FORMS  
MANUFACTURERS ASSOCIATION



**Table A.5.3200. Above Grade Shear Wall Length for Seismic Zone Classification,  $S_{a,ICF} \leq 0.16$  and Hourly Wind Pressure,  $0.5kPa < q_{1/50} \leq 0.75kPa$  (in a Building Without Walkout Basement), where Building Area  $\leq 3200ft^2$**

| Wall Height m (ft)   | Seismic Zone Classification               |                                |                                |                                 |                                 |                                  |
|--|---|--------------------------------|--------------------------------|---------------------------------|---------------------------------|----------------------------------|
|  | $S_{a,ICF} \leq 0.07$                     |                                | $S_{a,ICF} \leq 0.11$          |                                 | $S_{a,ICF} \leq 0.16$           |                                  |
| <b>Second Floor Walls of Two Story ICF Structure Supporting Wood Frame Roof (TYPE A)</b>                       |   |                                |                                |                                 |                                 |                                  |
|  | 6" & 8" Thick Wall                        |                                | 10" & 12" Thick Wall           |                                 | 6" & 8" Thick Wall              |                                  |
|  | Number and length of shear walls provided |                                |                                |                                 |                                 |                                  |
| 2.44 (8)   | 1 x 8'-0" 2 x 4'-0" 3 x 2'-8"             | 1 x 8'-0" 2 x 4'-0" 3 x 2'-8"  | 1 x 8'-0" 2 x 4'-0" 3 x 3'-0"  | 1 x 8'-0" 2 x 4'-0" 3 x 3'-0"   | 1 x 8'-0" 2 x 4'-6" 3 x 3'-6"   | 1 x 8'-0" 2 x 4'-0" 3 x 3'-0"    |
| 2.75 (9)   | 1 x 8'-0" 2 x 4'-0" 3 x 2'-8"             | 1 x 8'-0" 2 x 4'-0" 3 x 2'-8"  | 1 x 8'-0" 2 x 4'-0" 3 x 3'-0"  | 1 x 8'-0" 2 x 4'-0" 3 x 3'-0"   | 1 x 8'-0" 2 x 5'-0" 3 x 4'-0"   | 1 x 8'-6" 2 x 5'-6" 3 x 4'-0"    |
| 3.05 (10)  | 1 x 8'-0" 2 x 4'-0" 3 x 2'-8"             | 1 x 8'-0" 2 x 4'-0" 3 x 2'-8"  | 1 x 8'-0" 2 x 4'-6" 3 x 3'-6"  | 1 x 8'-0" 2 x 4'-6" 3 x 3'-6"   | 1 x 9'-0" 2 x 6'-0" 3 x 4'-6"   | 1 x 9'-0" 2 x 6'-0" 3 x 4'-8"    |
| <b>Main Floor Walls of One Story ICF Structure Supporting Wood Frame Roof (TYPE B)</b>                         |   |                                |                                |                                 |                                 |                                  |
|  | 6" & 8" Thick Wall                        |                                | 10" & 12" Thick Wall           |                                 | 6" & 8" Thick Wall              |                                  |
|  | Number and length of shear walls provided |                                |                                |                                 |                                 |                                  |
| 2.44 (8)   | 1 x 8'-0" 2 x 4'-0" 3 x 2'-8"             | 1 x 8'-0" 2 x 4'-0" 3 x 2'-8"  | 1 x 8'-0" 2 x 4'-0" 3 x 3'-0"  | 1 x 8'-0" 2 x 4'-0" 3 x 3'-0"   | 1 x 8'-0" 2 x 4'-0" 3 x 3'-0"   | 1 x 8'-0" 2 x 4'-0" 3 x 3'-0"    |
| 2.75 (9)   | 1 x 8'-0" 2 x 4'-0" 3 x 2'-8"             | 1 x 8'-0" 2 x 4'-0" 3 x 2'-8"  | 1 x 8'-0" 2 x 4'-0" 3 x 3'-0"  | 1 x 8'-0" 2 x 4'-0" 3 x 3'-0"   | 1 x 8'-0" 2 x 4'-0" 3 x 3'-0"   | 1 x 8'-0" 2 x 4'-6" 3 x 3'-6"    |
| 3.05 (10)  | 1 x 8'-0" 2 x 4'-0" 3 x 2'-8"             | 1 x 8'-0" 2 x 4'-0" 3 x 2'-8"  | 1 x 8'-0" 2 x 4'-0" 3 x 3'-0"  | 1 x 8'-0" 2 x 4'-0" 3 x 3'-0"   | 1 x 8'-0" 2 x 5'-0" 3 x 3'-6"   | 1 x 8'-0" 2 x 5'-0" 3 x 3'-6"    |
| 3.66 (12)  | 1 x 8'-0" 2 x 4'-0" 3 x 3'-0"             | 1 x 8'-0" 2 x 4'-0" 3 x 3'-0"  | 1 x 8'-0" 2 x 4'-6" 3 x 3'-6"  | 1 x 8'-0" 2 x 4'-6" 3 x 3'-6"   | 1 x 9'-0" 2 x 6'-0" 3 x 4'-6"   | 1 x 9'-0" 2 x 6'-0" 3 x 4'-6"    |
| 4.27 (14)  | 1 x 8'-0" 2 x 4'-0" 3 x 3'-0"             | 1 x 8'-0" 2 x 4'-0" 3 x 3'-0"  | 1 x 8'-0" 2 x 5'-0" 3 x 4'-0"  | 1 x 8'-0" 2 x 5'-0" 3 x 4'-0"   | 1 x 9'-4" 2 x 6'-0" 3 x 5'-0"   | 1 x 10'-0" 2 x 7'-0" 3 x 5'-6"   |
| 4.88 (16)  | 1 x 8'-0" 2 x 4'-0" 3 x 3'-0"             | 1 x 8'-0" 2 x 5'-0" 3 x 4'-0"  | 1 x 8'-0" 2 x 5'-0" 3 x 4'-0"  | 1 x 8'-0" 2 x 5'-0" 3 x 4'-0"   | 1 x 9'-0" 2 x 6'-0" 3 x 4'-6"   | 1 x 10'-0" 2 x 7'-6" 3 x 6'-0"   |
| <b>Main Floor Walls of Two Story Structure Supporting 2nd Story Wood Framed Walls, Floor and Roof (TYPE C)</b> |   |                                |                                |                                 |                                 |                                  |
|  | 6" & 8" Thick Wall                        |                                | 10" & 12" Thick Wall           |                                 | 6" & 8" Thick Wall              |                                  |
|  | Number and length of shear walls provided |                                |                                |                                 |                                 |                                  |
| 2.44 (8)   | 1 x 8'-0" 2 x 4'-6" 3 x 3'-6"             | 1 x 8'-0" 2 x 4'-0" 3 x 3'-0"  | 1 x 9'-0" 2 x 6'-0" 3 x 5'-0"  | 1 x 9'-0" 2 x 6'-6" 3 x 5'-0"   | 1 x 11'-6" 2 x 7'-6" 3 x 6'-0"  | 1 x 11'-6" 2 x 7'-0" 3 x 5'-6"   |
| 2.75 (9)   | 1 x 8'-0" 2 x 4'-6" 3 x 3'-6"             | 1 x 8'-0" 2 x 5'-0" 3 x 4'-0"  | 1 x 9'-0" 2 x 6'-6" 3 x 5'-0"  | 1 x 10'-0" 2 x 7'-0" 3 x 5'-0"  | 1 x 12'-0" 2 x 7'-6" 3 x 6'-0"  | 1 x 12'-0" 2 x 8'-0" 3 x 6'-0"   |
| 3.05 (10)  | 1 x 8'-0" 2 x 5'-0" 3 x 4'-0"             | 1 x 8'-0" 2 x 5'-0" 3 x 4'-0"  | 1 x 10'-0" 2 x 7'-4" 3 x 6'-0" | 1 x 10'-0" 2 x 7'-4" 3 x 6'-0"  | 1 x 12'-6" 2 x 8'-6" 3 x 6'-6"  | 1 x 12'-6" 2 x 8'-0" 3 x 6'-6"   |
| 3.66 (12)  | 1 x 8'-6" 2 x 5'-6" 3 x 4'-0"             | 1 x 8'-6" 2 x 5'-6" 3 x 4'-0"  | 1 x 10'-6" 2 x 8'-4" 3 x 6'-6" | 1 x 10'-6" 2 x 8'-4" 3 x 6'-6"  | 1 x 13'-0" 2 x 9'-0" 3 x 7'-0"  | 1 x 13'-0" 2 x 9'-0" 3 x 7'-0"   |
| 4.27 (14)  | 1 x 8'-6" 2 x 5'-6" 3 x 4'-6"             | 1 x 8'-6" 2 x 6'-0" 3 x 4'-6"  | 1 x 11'-0" 2 x 8'-6" 3 x 7'-0" | 1 x 11'-6" 2 x 9'-0" 3 x 7'-0"  | 1 x 13'-0" 2 x 9'-0" 3 x 7'-0"  | 1 x 14'-0" 2 x 10'-0" 3 x 7'-6"  |
| 4.88 (16)  | 1 x 8'-6" 2 x 5'-6" 3 x 4'-6"             | 1 x 9'-0" 2 x 6'-0" 3 x 5'-0"  | 1 x 11'-0" 2 x 9'-0" 3 x 7'-6" | 1 x 12'-0" 2 x 9'-6" 3 x 7'-6"  | 1 x 13'-0" 2 x 9'-0" 3 x 7'-6"  | 1 x 14'-6" 2 x 10'-0" 3 x 7'-6"  |
| <b>Main Floor Walls of Two Story ICF Structure Supporting Wood Frame Floors and Roof (TYPE D)</b>              |   |                                |                                |                                 |                                 |                                  |
|  | 6" & 8" Thick Wall                        |                                | 10" & 12" Thick Wall           |                                 | 6" & 8" Thick Wall              |                                  |
|  | Number and length of shear walls provided |                                |                                |                                 |                                 |                                  |
| 2.44 (8)   | 1 x 9'-0" 2 x 5'-6" 3 x 4'-6"             | 1 x 9'-0" 2 x 5'-6" 3 x 4'-6"  | 1 x 11'-0" 2 x 7'-6" 3 x 6'-0" | 1 x 12'-0" 2 x 8'-0" 3 x 6'-0"  | 1 x 14'-0" 2 x 9'-0" 3 x 7'-0"  | 1 x 16'-0" 2 x 10'-0" 3 x 8'-0"  |
| 2.75 (9)   | 1 x 9'-0" 2 x 6'-0" 3 x 4'-6"             | 1 x 10'-0" 2 x 6'-6" 3 x 5'-0" | 1 x 12'-0" 2 x 7'-6" 3 x 6'-0" | 1 x 13'-0" 2 x 8'-6" 3 x 6'-6"  | 1 x 15'-0" 2 x 9'-6" 3 x 8'-0"  | 1 x 16'-0" 2 x 11'-0" 3 x 8'-0"  |
| 3.05 (10)  | 1 x 9'-6" 2 x 6'-6" 3 x 5'-0"             | 1 x 10'-0" 2 x 6'-6" 3 x 5'-0" | 1 x 13'-0" 2 x 8'-6" 3 x 6'-6" | 1 x 13'-0" 2 x 8'-6" 3 x 7'-0"  | 1 x 15'-6" 2 x 10'-6" 3 x 8'-0" | 1 x 17'-0" 2 x 11'-0" 3 x 8'-6"  |
| 3.66 (12)  | 1 x 10'-0" 2 x 7'-0" 3 x 5'-0"            | 1 x 10'-6" 2 x 7'-0" 3 x 5'-6" | 1 x 13'-6" 2 x 9'-0" 3 x 7'-0" | 1 x 13'-6" 2 x 9'-0" 3 x 7'-0"  | 1 x 16'-0" 2 x 11'-0" 3 x 9'-0" | 1 x 17'-0" 2 x 11'-0" 3 x 9'-0"  |
| 4.27 (14)  | 1 x 10'-0" 2 x 7'-0" 3 x 5'-6"            | 1 x 11'-0" 2 x 7'-6" 3 x 6'-0" | 1 x 13'-0" 2 x 9'-0" 3 x 7'-0" | 1 x 14'-6" 2 x 9'-6" 3 x 8'-0"  | 1 x 16'-0" 2 x 11'-0" 3 x 9'-0" | 1 x 18'-0" 2 x 12'-0" 3 x 10'-0" |
| 4.88 (16)  | 1 x 10'-0" 2 x 7'-0" 3 x 5'-6"            | 1 x 11'-6" 2 x 7'-6" 3 x 6'-0" | 1 x 13'-0" 2 x 9'-0" 3 x 7'-0" | 1 x 14'-6" 2 x 10'-0" 3 x 8'-0" | 1 x 16'-0" 2 x 11'-0" 3 x 9'-0" | 1 x 18'-0" 2 x 12'-6" 3 x 10'-0" |
| Vertical Reinforcement   | ICF with 6" Tie Spacing                   | As per table A.1.1.            |                                | As per table A.1.1.             |                                 | As per table A.1.1.              |
|  | ICF with 8" Tie Spacing                   | As per table A.1.2.            |                                | As per table A.1.2.             |                                 | As per table A.1.2.              |
| Horizontal Reinforcement   | Block Height of 12" and 18"               | 10 M @ 450 (18)                | 10 M @ 450 (18)                | 10 M @ 450 (18)                 | 10 M @ 450 (18)                 | 10 M @ 450 (18)                  |
|  | Block Height of 16"                       | 10 M @ 400 (16)                | 10 M @ 400 (16)                | 10 M @ 400 (16)                 | 10 M @ 400 (16)                 | 10 M @ 400 (16)                  |

**NOTES:**

1.  $S_{a,ICF}$  is equivalent spectral response acceleration for ICF walls as provided in Appendix A.
2. This table is to be used in conjunction with the "Design Limitations."
3. Provide two layers of the indicated horizontal and vertical distributed steel specified for 300mm (12") walls. Place each layer as shown in the rebar placement drawing.
4. All four sides of the building are to have a minimum number and length of shear walls that conforms to this table.
5. Use Table A.6 for buildings that do not meet the required wall length of this table.
6. Provide 2-15M concentrated reinforcement at each end of shear walls as shown in shear wall detail.
7. All concentrated reinforcement is to be continues to the bottom of the foundation wall. Provide lap splices as required.
8. Concentrated reinforcement is to be placed in accordance with Bar Placement Detail.

# INSULATING CONCRETE FORMS MANUFACTURERS ASSOCIATION



**Table A.6.3200. Above Grade Shear Wall Length for Seismic Zone Classification,  $S_{a,ICF} > 0.16$  and Hourly Wind Pressure,  $q_{1/50} \leq 1.05\text{kPa}$  (in a Building Without Walkout Basement), where Building Area  $\leq 3200\text{ft}^2$**

| Wall HC49AB87  | Seismic Zone Classification               |          |                      |                       |                     |          |                       |           |                     |                       |                      |           |
|--|---|----------|----------------------|-----------------------|---------------------|----------|-----------------------|-----------|---------------------|-----------------------|----------------------|-----------|
|  | $S_{a,ICF} \leq 0.16$                     |          |                      | $S_{a,ICF} \leq 0.31$ |                     |          | $S_{a,ICF} \leq 0.53$ |           |                     | $S_{a,ICF} \leq 0.79$ |                      |           |
| <b>Second Floor Walls of Two Story ICF Structure Supporting Wood Frame Roof (TYPE A)</b>                       |   |          |                      |                       |                     |          |                       |           |                     |                       |                      |           |
|  | 6' & 8' Thick Wall                        |          | 10' & 12' Thick Wall |                       | 6' & 8' Thick Wall  |          | 10' & 12' Thick Wall  |           | 6' & 8' Thick Wall  |                       | 10' & 12' Thick Wall |           |
|  | Number and length of shear walls provided |          |                      |                       |                     |          |                       |           |                     |                       |                      |           |
| 2.44 (8)   | 1x 8'-0"                                  | 2x 4'-0" | 3x 3'-0"             | 1x 8'-0"              | 2x 4'-0"            | 3x 3'-0" | 1x 8'-0"              | 2x 5'-0"  | 3x 4'-0"            | 1x 8'-0"              | 2x 5'-0"             | 3x 4'-0"  |
| 2.75 (9)   | 1x 8'-0"                                  | 2x 4'-0" | 3x 3'-0"             | 1x 8'-0"              | 2x 4'-0"            | 3x 3'-0" | 1x 9'-0"              | 2x 6'-0"  | 3x 4'-0"            | 1x 10'-0"             | 2x 8'-0"             | 3x 6'-0"  |
| 3.05 (10)  | 1x 8'-0"                                  | 2x 5'-0" | 3x 3'-0"             | 1x 8'-0"              | 2x 4'-0"            | 3x 3'-0" | 1x 9'-0"              | 2x 6'-0"  | 3x 5'-0"            | 1x 11'-0"             | 2x 7'-0"             | 3x 6'-0"  |
| 3.66 (12)  | 1x 8'-0"                                  | 2x 4'-0" | 3x 4'-0"             | 1x 8'-0"              | 2x 5'-0"            | 3x 4'-0" | 1x 9'-0"              | 2x 6'-0"  | 3x 6'-0"            | 1x 11'-0"             | 2x 8'-0"             | 3x 7'-0"  |
| 4.27 (14)  | 1x 8'-0"                                  | 2x 5'-0" | 3x 4'-0"             | 1x 8'-0"              | 2x 5'-0"            | 3x 4'-0" | 1x 11'-0"             | 2x 7'-0"  | 3x 7'-0"            | 1x 14'-0"             | 2x 10'-0"            | 3x 8'-0"  |
| 4.88 (16)  | 1x 8'-0"                                  | 2x 5'-0" | 3x 4'-0"             | 1x 8'-0"              | 2x 6'-0"            | 3x 5'-0" | 1x 11'-0"             | 2x 8'-0"  | 3x 8'-0"            | 1x 15'-0"             | 2x 11'-0"            | 3x 9'-0"  |
| <b>Main Floor Walls of One Story ICF Structure Supporting Wood Frame Roof (TYPE B)</b>                         |   |          |                      |                       |                     |          |                       |           |                     |                       |                      |           |
|  | 6' & 8' Thick Wall                        |          | 10' & 12' Thick Wall |                       | 6' & 8' Thick Wall  |          | 10' & 12' Thick Wall  |           | 6' & 8' Thick Wall  |                       | 10' & 12' Thick Wall |           |
|  | Number and length of shear walls provided |          |                      |                       |                     |          |                       |           |                     |                       |                      |           |
| 2.44 (8)   | 1x 8'-0"                                  | 2x 4'-0" | 3x 3'-0"             | 1x 8'-0"              | 2x 4'-0"            | 3x 3'-0" | 1x 8'-0"              | 2x 5'-0"  | 3x 4'-0"            | 1x 9'-0"              | 2x 6'-0"             | 3x 4'-0"  |
| 2.75 (9)   | 1x 8'-0"                                  | 2x 4'-0" | 3x 3'-0"             | 1x 8'-0"              | 2x 4'-0"            | 3x 3'-0" | 1x 8'-0"              | 2x 5'-0"  | 3x 4'-0"            | 1x 10'-0"             | 2x 7'-0"             | 3x 5'-0"  |
| 3.05 (10)  | 1x 8'-0"                                  | 2x 4'-0" | 3x 3'-0"             | 1x 8'-0"              | 2x 4'-0"            | 3x 3'-0" | 1x 9'-0"              | 2x 6'-0"  | 3x 5'-0"            | 1x 11'-0"             | 2x 8'-0"             | 3x 6'-0"  |
| 3.66 (12)  | 1x 8'-0"                                  | 2x 4'-0" | 3x 4'-0"             | 1x 8'-0"              | 2x 5'-0"            | 3x 4'-0" | 1x 9'-0"              | 2x 6'-0"  | 3x 6'-0"            | 1x 13'-0"             | 2x 9'-0"             | 3x 7'-0"  |
| 4.27 (14)  | 1x 8'-0"                                  | 2x 5'-0" | 3x 4'-0"             | 1x 8'-0"              | 2x 5'-0"            | 3x 4'-0" | 1x 11'-0"             | 2x 7'-0"  | 3x 7'-0"            | 1x 15'-0"             | 2x 10'-0"            | 3x 8'-0"  |
| 4.88 (16)  | 1x 8'-0"                                  | 2x 5'-0" | 3x 4'-0"             | 1x 8'-0"              | 2x 6'-0"            | 3x 5'-0" | 1x 11'-0"             | 2x 8'-0"  | 3x 8'-0"            | 1x 17'-0"             | 2x 11'-0"            | 3x 9'-0"  |
| <b>Main Floor Walls of Two Story Structure Supporting 2nd Story Wood Framed Walls, Floor and Roof (TYPE C)</b> |   |          |                      |                       |                     |          |                       |           |                     |                       |                      |           |
|  | 6' & 8' Thick Wall                        |          | 10' & 12' Thick Wall |                       | 6' & 8' Thick Wall  |          | 10' & 12' Thick Wall  |           | 6' & 8' Thick Wall  |                       | 10' & 12' Thick Wall |           |
|  | Number and length of shear walls provided |          |                      |                       |                     |          |                       |           |                     |                       |                      |           |
| 2.44 (8)   | 1x 9'-0"                                  | 2x 6'-0" | 3x 5'-0"             | 1x 9'-0"              | 2x 6'-0"            | 3x 5'-0" | 1x 13'-0"             | 2x 9'-0"  | 3x 6'-0"            | 1x 17'-0"             | 2x 11'-0"            | 3x 9'-0"  |
| 2.75 (9)   | 1x 9'-0"                                  | 2x 6'-0" | 3x 5'-0"             | 1x 9'-0"              | 2x 6'-0"            | 3x 5'-0" | 1x 14'-0"             | 2x 10'-0" | 3x 7'-0"            | 1x 17'-0"             | 2x 11'-0"            | 3x 9'-0"  |
| 3.05 (10)  | 1x 10'-0"                                 | 2x 6'-0" | 3x 5'-0"             | 1x 10'-0"             | 2x 6'-0"            | 3x 5'-0" | 1x 15'-0"             | 2x 10'-0" | 3x 8'-0"            | 1x 17'-0"             | 2x 12'-0"            | 3x 10'-0" |
| 3.66 (12)  | 1x 10'-0"                                 | 2x 7'-0" | 3x 6'-0"             | 1x 11'-0"             | 2x 7'-0"            | 3x 6'-0" | 1x 15'-0"             | 2x 10'-0" | 3x 9'-0"            | 1x 19'-0"             | 2x 13'-0"            | 3x 11'-0" |
| 4.27 (14)  | 1x 11'-0"                                 | 2x 7'-0" | 3x 6'-0"             | 1x 11'-0"             | 2x 7'-0"            | 3x 6'-0" | 1x 16'-0"             | 2x 11'-0" | 3x 10'-0"           | 1x 20'-0"             | 2x 14'-0"            | 3x 12'-0" |
| 4.88 (16)  | 1x 11'-0"                                 | 2x 7'-0" | 3x 6'-0"             | 1x 11'-0"             | 2x 7'-0"            | 3x 6'-0" | 1x 16'-0"             | 2x 12'-0" | 3x 10'-0"           | 1x 21'-0"             | 2x 14'-0"            | 3x 13'-0" |
| <b>Main Floor Walls of Two Story ICF Structure Supporting Wood Frame Floors and Roof (TYPE D)</b>              |   |          |                      |                       |                     |          |                       |           |                     |                       |                      |           |
|  | 6' & 8' Thick Wall                        |          | 10' & 12' Thick Wall |                       | 6' & 8' Thick Wall  |          | 10' & 12' Thick Wall  |           | 6' & 8' Thick Wall  |                       | 10' & 12' Thick Wall |           |
|  | Number and length of shear walls provided |          |                      |                       |                     |          |                       |           |                     |                       |                      |           |
| 2.44 (8)   | 1x 11'-0"                                 | 2x 7'-0" | 3x 5'-0"             | 1x 12'-0"             | 2x 7'-0"            | 3x 6'-0" | 1x 16'-0"             | 2x 11'-0" | 3x 8'-0"            | 1x 17'-0"             | 2x 11'-0"            | 3x 9'-0"  |
| 2.75 (9)   | 1x 12'-0"                                 | 2x 8'-0" | 3x 6'-0"             | 1x 12'-0"             | 2x 8'-0"            | 3x 6'-0" | 1x 17'-0"             | 2x 12'-0" | 3x 9'-0"            | 1x 20'-0"             | 2x 13'-0"            | 3x 10'-0" |
| 3.05 (10)  | 1x 12'-0"                                 | 2x 8'-0" | 3x 6'-0"             | 1x 13'-0"             | 2x 8'-0"            | 3x 6'-0" | 1x 18'-0"             | 2x 12'-0" | 3x 9'-0"            | 1x 21'-0"             | 2x 13'-0"            | 3x 10'-0" |
| 3.66 (12)  | 1x 12'-0"                                 | 2x 8'-0" | 3x 7'-0"             | 1x 14'-0"             | 2x 10'-0"           | 3x 7'-0" | 1x 19'-0"             | 2x 12'-0" | 3x 10'-0"           | 1x 23'-0"             | 2x 16'-0"            | 3x 13'-0" |
| 4.27 (14)  | 1x 13'-0"                                 | 2x 9'-0" | 3x 7'-0"             | 1x 13'-0"             | 2x 10'-0"           | 3x 7'-0" | 1x 19'-0"             | 2x 13'-0" | 3x 11'-0"           | 1x 24'-0"             | 2x 17'-0"            | 3x 14'-0" |
| 4.88 (16)  | 1x 13'-0"                                 | 2x 9'-0" | 3x 7'-0"             | 1x 14'-0"             | 2x 10'-0"           | 3x 8'-0" | 1x 19'-0"             | 2x 13'-0" | 3x 11'-0"           | 1x 24'-0"             | 2x 17'-0"            | 3x 14'-0" |
| Vertical ICF with 6" Tie Spacing   | As per table A.2.1.                       |          | As per table A.2.1.  |                       | As per table A.2.1. |          | As per table A.2.1.   |           | As per table A.2.1. |                       | As per table A.2.1.  |           |
| Vertical ICF with 8" Tie Spacing   | As per table A.2.2.                       |          | As per table A.2.2.  |                       | As per table A.2.2. |          | As per table A.2.2.   |           | As per table A.2.2. |                       | As per table A.2.2.  |           |
| Horizontal Reinforcement Block Height of 12" and 18"   | As per table A.2.1.                       |          | As per table A.2.1.  |                       | As per table A.2.1. |          | As per table A.2.1.   |           | As per table A.2.1. |                       | As per table A.2.1.  |           |
| Horizontal Reinforcement Block Height of 16"   | As per table A.2.2.                       |          | As per table A.2.2.  |                       | As per table A.2.2. |          | As per table A.2.2.   |           | As per table A.2.2. |                       | As per table A.2.2.  |           |

**NOTES:**

- $S_{a,ICF}$  is equivalent spectral response acceleration for ICF walls as provided in Appendix A.
- This table is to be used in conjunction with the "Design Limitations."
- Provide two layers of the indicated horizontal and vertical distributed steel specified for 300mm (12") walls. Place each layer as shown in the rebar placement drawing.
- All four sides of the building are to have a minimum number and length of shear walls that conforms to this table.
- Provide 2-15M concentrated reinforcement at each end of shear walls as shown in shear wall detail.
- All concentrated reinforcement is to be continued to the bottom of the foundation wall. Provide lap splices as required.
- Concentrated reinforcement is to be placed in accordance with Bar Placement Detail.
- Horizontal reinforcement in shear walls where  $S_{a,ICF} > 0.16$  must be anchored using a standard 180° hook around vertical end bars.
- When using this table for  $S_{a,ICF} \leq 0.16$ , use the vertical and horizontal distributed steel in Tables A.2.1. or A.2.2.

INSULATING CONCRETE FORMS MANUFACTURERS ASSOCIATION



**Table A.7.3200. Above Grade Shear Wall Length for Seismic Zone Classification,  $S_{a,ICF} \leq 0.16$  and Hourly Wind Pressure,  $q_{1/50} \leq 0.5kPa$  (in a Building With Walk Basement), where Building Area  $\leq 3200ft^2$**

| Wall Height m (ft)   | Seismic Zone Classification               |           |                       |            |                       |           |                      |            |           |            |            |           |            |            |            |            |            |            |
|--|---|-----------|-----------------------|------------|-----------------------|-----------|----------------------|------------|-----------|------------|------------|-----------|------------|------------|------------|------------|------------|------------|
|  | $S_{a,ICF} \leq 0.07$                     |           | $S_{a,ICF} \leq 0.11$ |            | $S_{a,ICF} \leq 0.16$ |           |                      |            |           |            |            |           |            |            |            |            |            |            |
| <b>Second Floor Walls of Two Story ICF Structure Supporting Wood Frame Roof (TYPE E)</b>                       |   |           |                       |            |                       |           |                      |            |           |            |            |           |            |            |            |            |            |            |
|  | 6" & 8" Thick Wall                        |           | 10" & 12" Thick Wall  |            | 6" & 8" Thick Wall    |           | 10" & 12" Thick Wall |            |           |            |            |           |            |            |            |            |            |            |
|  | Number and length of shear walls provided |           |                       |            |                       |           |                      |            |           |            |            |           |            |            |            |            |            |            |
| 2.44 (8)   | 1 x 8'-0"                                 | 2 x 4'-0" | 3 x 2'-8"             | 1 x 8'-0"  | 2 x 4'-0"             | 3 x 2'-8" | 1 x 8'-0"            | 2 x 4'-0"  | 3 x 3'-0" | 1 x 8'-0"  | 2 x 4'-0"  | 3 x 3'-0" | 1 x 8'-0"  | 2 x 4'-6"  | 3 x 4'-0"  | 1 x 8'-0"  | 2 x 5'-0"  | 3 x 4'-0"  |
| 2.75 (9)   | 1 x 8'-0"                                 | 2 x 4'-0" | 3 x 2'-8"             | 1 x 8'-0"  | 2 x 4'-0"             | 3 x 2'-8" | 1 x 8'-0"            | 2 x 4'-0"  | 3 x 3'-0" | 1 x 8'-0"  | 2 x 4'-4"  | 3 x 3'-4" | 1 x 8'-0"  | 2 x 4'-6"  | 3 x 4'-4"  | 1 x 8'-0"  | 2 x 5'-4"  | 3 x 4'-4"  |
| 3.05 (10)  | 1 x 8'-0"                                 | 2 x 4'-0" | 3 x 2'-8"             | 1 x 8'-0"  | 2 x 4'-0"             | 3 x 2'-8" | 1 x 8'-0"            | 2 x 4'-8"  | 3 x 3'-6" | 1 x 8'-0"  | 2 x 5'-0"  | 3 x 3'-6" | 1 x 8'-0"  | 2 x 5'-6"  | 3 x 4'-4"  | 1 x 8'-0"  | 2 x 5'-8"  | 3 x 4'-4"  |
| 3.66 (12)  | 1 x 8'-0"                                 | 2 x 4'-0" | 3 x 3'-0"             | 1 x 8'-0"  | 2 x 4'-0"             | 3 x 3'-0" | 1 x 8'-6"            | 2 x 5'-6"  | 3 x 4'-4" | 1 x 8'-6"  | 2 x 5'-6"  | 3 x 4'-4" | 1 x 10'-6" | 2 x 7'-0"  | 3 x 5'-6"  | 1 x 11'-0" | 2 x 7'-0"  | 3 x 5'-6"  |
| 4.27 (14)  | 1 x 8'-0"                                 | 2 x 4'-6" | 3 x 4'-0"             | 1 x 8'-0"  | 2 x 5'-0"             | 3 x 4'-0" | 1 x 10'-0"           | 2 x 6'-0"  | 3 x 4'-8" | 1 x 10'-6" | 2 x 7'-0"  | 3 x 5'-4" | 1 x 11'-6" | 2 x 7'-6"  | 3 x 6'-0"  | 1 x 12'-6" | 2 x 8'-4"  | 3 x 6'-6"  |
| 4.88 (16)  | 1 x 8'-0"                                 | 2 x 5'-0" | 3 x 4'-0"             | 1 x 9'-0"  | 2 x 5'-6"             | 3 x 4'-6" | 1 x 10'-0"           | 2 x 6'-6"  | 3 x 5'-0" | 1 x 11'-0" | 2 x 7'-6"  | 3 x 5'-8" | 1 x 12'-0" | 2 x 8'-0"  | 3 x 6'-6"  | 1 x 14'-0" | 2 x 9'-4"  | 3 x 7'-4"  |
| <b>Main Floor Walls of One Story ICF Structure Supporting Wood Frame Roof (TYPE F)</b>                         |   |           |                       |            |                       |           |                      |            |           |            |            |           |            |            |            |            |            |            |
|  | 6" & 8" Thick Wall                        |           | 10" & 12" Thick Wall  |            | 6" & 8" Thick Wall    |           | 10" & 12" Thick Wall |            |           |            |            |           |            |            |            |            |            |            |
|  | Number and length of shear walls provided |           |                       |            |                       |           |                      |            |           |            |            |           |            |            |            |            |            |            |
| 2.44 (8)   | 1 x 8'-0"                                 | 2 x 4'-0" | 3 x 2'-8"             | 1 x 8'-0"  | 2 x 4'-0"             | 3 x 2'-8" | 1 x 8'-0"            | 2 x 4'-0"  | 3 x 3'-0" | 1 x 8'-0"  | 2 x 4'-0"  | 3 x 3'-0" | 1 x 8'-0"  | 2 x 4'-6"  | 3 x 3'-6"  | 1 x 8'-0"  | 2 x 4'-6"  | 3 x 3'-8"  |
| 2.75 (9)   | 1 x 8'-0"                                 | 2 x 4'-0" | 3 x 2'-8"             | 1 x 8'-0"  | 2 x 4'-0"             | 3 x 2'-8" | 1 x 8'-0"            | 2 x 4'-0"  | 3 x 3'-0" | 1 x 8'-0"  | 2 x 4'-0"  | 3 x 3'-0" | 1 x 8'-0"  | 2 x 4'-6"  | 3 x 3'-6"  | 1 x 8'-0"  | 2 x 5'-0"  | 3 x 3'-8"  |
| 3.05 (10)  | 1 x 8'-0"                                 | 2 x 4'-0" | 3 x 2'-8"             | 1 x 8'-0"  | 2 x 4'-0"             | 3 x 2'-8" | 1 x 8'-0"            | 2 x 4'-6"  | 3 x 3'-6" | 1 x 8'-0"  | 2 x 4'-6"  | 3 x 3'-6" | 1 x 8'-0"  | 2 x 5'-6"  | 3 x 4'-4"  | 1 x 9'-6"  | 2 x 5'-8"  | 3 x 4'-4"  |
| 3.66 (12)  | 1 x 8'-0"                                 | 2 x 4'-0" | 3 x 3'-0"             | 1 x 8'-0"  | 2 x 4'-0"             | 3 x 3'-0" | 1 x 8'-6"            | 2 x 5'-6"  | 3 x 4'-4" | 1 x 8'-6"  | 2 x 5'-6"  | 3 x 4'-4" | 1 x 10'-6" | 2 x 7'-0"  | 3 x 5'-6"  | 1 x 11'-0" | 2 x 7'-0"  | 3 x 5'-6"  |
| 4.27 (14)  | 1 x 8'-0"                                 | 2 x 4'-6" | 3 x 4'-0"             | 1 x 8'-0"  | 2 x 5'-0"             | 3 x 4'-0" | 1 x 10'-0"           | 2 x 6'-0"  | 3 x 4'-8" | 1 x 10'-6" | 2 x 7'-0"  | 3 x 5'-4" | 1 x 11'-6" | 2 x 7'-6"  | 3 x 6'-0"  | 1 x 12'-6" | 2 x 8'-4"  | 3 x 6'-6"  |
| 4.88 (16)  | 1 x 8'-0"                                 | 2 x 5'-0" | 3 x 4'-0"             | 1 x 9'-0"  | 2 x 5'-6"             | 3 x 4'-6" | 1 x 10'-0"           | 2 x 6'-6"  | 3 x 5'-0" | 1 x 11'-0" | 2 x 7'-6"  | 3 x 5'-8" | 1 x 12'-0" | 2 x 8'-0"  | 3 x 6'-6"  | 1 x 14'-0" | 2 x 9'-4"  | 3 x 7'-4"  |
| <b>Main Floor Walls of Two Story Structure Supporting 2nd Story Wood Framed Walls, Floor and Roof (TYPE G)</b> |   |           |                       |            |                       |           |                      |            |           |            |            |           |            |            |            |            |            |            |
|  | 6" & 8" Thick Wall                        |           | 10" & 12" Thick Wall  |            | 6" & 8" Thick Wall    |           | 10" & 12" Thick Wall |            |           |            |            |           |            |            |            |            |            |            |
|  | Number and length of shear walls provided |           |                       |            |                       |           |                      |            |           |            |            |           |            |            |            |            |            |            |
| 2.44 (8)   | 1 x 8'-0"                                 | 2 x 5'-0" | 3 x 4'-0"             | 1 x 8'-0"  | 2 x 5'-0"             | 3 x 4'-0" | 1 x 10'-0"           | 2 x 6'-0"  | 3 x 5'-0" | 1 x 10'-0" | 2 x 6'-6"  | 3 x 5'-0" | 1 x 12'-6" | 2 x 8'-0"  | 3 x 6'-0"  | 1 x 13'-0" | 2 x 8'-0"  | 3 x 6'-6"  |
| 2.75 (9)   | 1 x 8'-0"                                 | 2 x 5'-0" | 3 x 4'-0"             | 1 x 8'-0"  | 2 x 5'-0"             | 3 x 4'-0" | 1 x 10'-6"           | 2 x 6'-6"  | 3 x 5'-0" | 1 x 11'-0" | 2 x 7'-0"  | 3 x 5'-0" | 1 x 13'-6" | 2 x 8'-6"  | 3 x 6'-6"  | 1 x 13'-8" | 2 x 9'-0"  | 3 x 7'-0"  |
| 3.05 (10)  | 1 x 8'-6"                                 | 2 x 5'-6" | 3 x 4'-4"             | 1 x 8'-6"  | 2 x 5'-6"             | 3 x 4'-4" | 1 x 11'-6"           | 2 x 7'-4"  | 3 x 6'-0" | 1 x 11'-6" | 2 x 7'-4"  | 3 x 6'-0" | 1 x 14'-0" | 2 x 9'-4"  | 3 x 7'-4"  | 1 x 14'-6" | 2 x 9'-4"  | 3 x 7'-4"  |
| 3.66 (12)  | 1 x 9'-4"                                 | 2 x 6'-4" | 3 x 5'-0"             | 1 x 9'-4"  | 2 x 6'-4"             | 3 x 5'-0" | 1 x 12'-4"           | 2 x 8'-4"  | 3 x 6'-6" | 1 x 12'-4" | 2 x 8'-4"  | 3 x 6'-6" | 1 x 15'-0" | 2 x 10'-4" | 3 x 8'-0"  | 1 x 15'-0" | 2 x 10'-4" | 3 x 8'-0"  |
| 4.27 (14)  | 1 x 9'-8"                                 | 2 x 6'-8" | 3 x 5'-4"             | 1 x 10'-4" | 2 x 7'-0"             | 3 x 5'-4" | 1 x 12'-8"           | 2 x 8'-6"  | 3 x 7'-0" | 1 x 13'-6" | 2 x 9'-0"  | 3 x 7'-0" | 1 x 15'-6" | 2 x 10'-6" | 3 x 8'-6"  | 1 x 16'-4" | 2 x 11'-4" | 3 x 9'-0"  |
| 4.88 (16)  | 1 x 10'-0"                                | 2 x 7'-0" | 3 x 5'-6"             | 1 x 11'-0" | 2 x 7'-4"             | 3 x 5'-8" | 1 x 13'-0"           | 2 x 9'-0"  | 3 x 7'-6" | 1 x 14'-0" | 2 x 9'-6"  | 3 x 7'-6" | 1 x 15'-6" | 2 x 10'-6" | 3 x 8'-6"  | 1 x 17'-0" | 2 x 11'-6" | 3 x 9'-4"  |
| <b>Main Floor Walls of Two Story ICF Structure Supporting Wood Frame Floors and Roof (TYPE H)</b>              |   |           |                       |            |                       |           |                      |            |           |            |            |           |            |            |            |            |            |            |
|  | 6" & 8" Thick Wall                        |           | 10" & 12" Thick Wall  |            | 6" & 8" Thick Wall    |           | 10" & 12" Thick Wall |            |           |            |            |           |            |            |            |            |            |            |
|  | Number and length of shear walls provided |           |                       |            |                       |           |                      |            |           |            |            |           |            |            |            |            |            |            |
| 2.44 (8)   | 1 x 9'-4"                                 | 2 x 6'-0" | 3 x 4'-6"             | 1 x 10'-0" | 2 x 6'-4"             | 3 x 5'-0" | 1 x 12'-6"           | 2 x 8'-0"  | 3 x 6'-0" | 1 x 13'-4" | 2 x 8'-6"  | 3 x 6'-6" | 1 x 16'-0" | 2 x 10'-0" | 3 x 8'-0"  | 1 x 16'-6" | 2 x 11'-0" | 3 x 8'-6"  |
| 2.75 (9)   | 1 x 9'-8"                                 | 2 x 6'-6" | 3 x 4'-8"             | 1 x 11'-0" | 2 x 6'-6"             | 3 x 5'-0" | 1 x 13'-0"           | 2 x 8'-4"  | 3 x 6'-6" | 1 x 14'-0" | 2 x 9'-0"  | 3 x 7'-0" | 1 x 16'-6" | 2 x 11'-0" | 3 x 8'-6"  | 1 x 17'-6" | 2 x 11'-6" | 3 x 9'-0"  |
| 3.05 (10)  | 1 x 10'-4"                                | 2 x 6'-6" | 3 x 5'-0"             | 1 x 11'-0" | 2 x 7'-0"             | 3 x 5'-6" | 1 x 13'-8"           | 2 x 9'-0"  | 3 x 7'-0" | 1 x 15'-0" | 2 x 9'-6"  | 3 x 7'-6" | 1 x 17'-6" | 2 x 11'-6" | 3 x 9'-0"  | 1 x 18'-6" | 2 x 12'-0" | 3 x 9'-6"  |
| 3.66 (12)  | 1 x 11'-6"                                | 2 x 7'-6" | 3 x 6'-0"             | 1 x 11'-6" | 2 x 7'-6"             | 3 x 6'-0" | 1 x 14'-6"           | 2 x 10'-0" | 3 x 7'-8" | 1 x 15'-0" | 2 x 10'-0" | 3 x 7'-8" | 1 x 18'-0" | 2 x 12'-4" | 3 x 9'-8"  | 1 x 19'-0" | 2 x 12'-4" | 3 x 9'-8"  |
| 4.27 (14)  | 1 x 11'-6"                                | 2 x 8'-0" | 3 x 6'-6"             | 1 x 12'-6" | 2 x 8'-6"             | 3 x 7'-0" | 1 x 15'-0"           | 2 x 10'-0" | 3 x 8'-0" | 1 x 16'-6" | 2 x 11'-0" | 3 x 9'-0" | 1 x 18'-4" | 2 x 12'-6" | 3 x 10'-0" | 1 x 21'-0" | 2 x 13'-6" | 3 x 11'-0" |
| 4.88 (16)  | 1 x 11'-6"                                | 2 x 8'-0" | 3 x 6'-6"             | 1 x 13'-0" | 2 x 9'-0"             | 3 x 7'-6" | 1 x 15'-0"           | 2 x 10'-0" | 3 x 8'-0" | 1 x 17'-6" | 2 x 12'-0" | 3 x 9'-0" | 1 x 18'-4" | 2 x 12'-6" | 3 x 10'-0" | 1 x 21'-0" | 2 x 14'-4" | 3 x 11'-4" |
| Vertical Reinforcement   | ICF with 6" Tie Spacing                   |           | As per table A.1.1.   |            | As per table A.1.1.   |           | As per table A.1.1.  |            |           |            |            |           |            |            |            |            |            |            |
|  | ICF with 8" Tie Spacing                   |           | As per table A.1.2.   |            | As per table A.1.2.   |           | As per table A.1.2.  |            |           |            |            |           |            |            |            |            |            |            |
| Horizontal Reinforcement   | Block Height of 12" and 18"               |           | 10 M @ 450 (18)       |            | 10 M @ 450 (18)       |           | 10 M @ 450 (18)      |            |           |            |            |           |            |            |            |            |            |            |
|  | Block Height of 16"                       |           | 10 M @ 400 (16)       |            | 10 M @ 400 (16)       |           | 10 M @ 400 (16)      |            |           |            |            |           |            |            |            |            |            |            |

**NOTES:**

1.  $S_{a,ICF}$  is equivalent spectral response acceleration for ICF walls as provided in Appendix A.
2. This table is to be used in conjunction with the "Design Limitations."
3. Provide two layers of the indicated horizontal and vertical distributed steel specified for 300mm (12") walls. Place each layer as shown in the rebar placement drawing.
4. All four sides of the building are to have a minimum number and length of shear walls that conforms to this table.
5. Use Table A.6 for buildings that do not meet the required wall length of this table.
6. Provide 2-15M concentrated reinforcement at each end of shear walls as shown in shear wall detail.
7. All concentrated reinforcement is to be continues to the bottom of the foundation wall. Provide lap splices as required.
8. Concentrated reinforcement is to be placed in accordance with Bar Placement Detail.

INSULATING CONCRETE FORMS MANUFACTURERS ASSOCIATION



**Table A.8.3200. Above Grade Shear Wall Length for Seismic Zone Classification,  $S_{a,ICF} \leq 0.16$  and Hourly Wind Pressure,  $0.5kPa < q1/50 \leq 0.75kPa$  (in a Building With Walkout Basement), where Building Area  $\leq 3200ft^2$**

| Wall Height m (ft)   | $S_{a,ICF} \leq 0.07$                     |           |                      | Seismic Zone Classification |                    |           | $S_{a,ICF} \leq 0.16$ |            |                    |                     |            |           |            |            |            |            |            |            |
|--|---|-----------|----------------------|-----------------------------|--------------------|-----------|-----------------------|------------|--------------------|---------------------|------------|-----------|------------|------------|------------|------------|------------|------------|
|  | $S_{a,ICF} \leq 0.07$                     |           |                      | $S_{a,ICF} \leq 0.11$       |                    |           | $S_{a,ICF} \leq 0.16$ |            |                    |                     |            |           |            |            |            |            |            |            |
| <b>Second Floor Walls of Two Story ICF Structure Supporting Wood Frame Roof (TYPE E)</b>                       |   |           |                      |                             |                    |           |                       |            |                    |                     |            |           |            |            |            |            |            |            |
|  | 6" & 8" Thick Wall                        |           | 10" & 12" Thick Wall |                             | 6" & 8" Thick Wall |           | 10" & 12" Thick Wall  |            | 6" & 8" Thick Wall |                     |            |           |            |            |            |            |            |            |
|  | Number and length of shear walls provided |           |                      |                             |                    |           |                       |            |                    |                     |            |           |            |            |            |            |            |            |
| 2.44 (8)   | 1 x 8'-0"                                 | 2 x 4'-0" | 3 x 2'-8"            | 1 x 8'-0"                   | 2 x 4'-0"          | 3 x 2'-8" | 1 x 8'-0"             | 2 x 4'-0"  | 3 x 3'-0"          | 1 x 8'-0"           | 2 x 4'-0"  | 3 x 3'-0" | 1 x 8'-0"  | 2 x 5'-0"  | 3 x 4'-0"  | 1 x 8'-0"  | 2 x 5'-0"  | 3 x 4'-0"  |
| 2.75 (9)   | 1 x 8'-0"                                 | 2 x 4'-0" | 3 x 2'-8"            | 1 x 8'-0"                   | 2 x 4'-0"          | 3 x 2'-8" | 1 x 8'-0"             | 2 x 4'-0"  | 3 x 3'-0"          | 1 x 8'-0"           | 2 x 4'-4"  | 3 x 3'-4" | 1 x 8'-6"  | 2 x 5'-4"  | 3 x 4'-4"  | 1 x 9'-4"  | 2 x 5'-6"  | 3 x 4'-4"  |
| 3.05 (10)  | 1 x 8'-0"                                 | 2 x 4'-0" | 3 x 3'-0"            | 1 x 8'-0"                   | 2 x 4'-0"          | 3 x 2'-8" | 1 x 8'-0"             | 2 x 5'-0"  | 3 x 4'-0"          | 1 x 8'-0"           | 2 x 5'-0"  | 3 x 3'-6" | 1 x 10'-0" | 2 x 6'-6"  | 3 x 5'-0"  | 1 x 10'-6" | 2 x 6'-4"  | 3 x 5'-0"  |
| <b>Main Floor Walls of One Story ICF Structure Supporting Wood Frame Roof (TYPE F)</b>                         |   |           |                      |                             |                    |           |                       |            |                    |                     |            |           |            |            |            |            |            |            |
|  | 6" & 8" Thick Wall                        |           | 10" & 12" Thick Wall |                             | 6" & 8" Thick Wall |           | 10" & 12" Thick Wall  |            | 6" & 8" Thick Wall |                     |            |           |            |            |            |            |            |            |
|  | Number and length of shear walls provided |           |                      |                             |                    |           |                       |            |                    |                     |            |           |            |            |            |            |            |            |
| 2.44 (8)   | 1 x 8'-0"                                 | 2 x 4'-0" | 3 x 2'-8"            | 1 x 8'-0"                   | 2 x 4'-0"          | 3 x 2'-8" | 1 x 8'-0"             | 2 x 4'-0"  | 3 x 3'-0"          | 1 x 8'-0"           | 2 x 4'-0"  | 3 x 3'-0" | 1 x 8'-0"  | 2 x 4'-6"  | 3 x 3'-4"  | 1 x 8'-0"  | 2 x 4'-6"  | 3 x 3'-4"  |
| 2.75 (9)   | 1 x 8'-0"                                 | 2 x 4'-0" | 3 x 2'-8"            | 1 x 8'-0"                   | 2 x 4'-0"          | 3 x 2'-8" | 1 x 8'-0"             | 2 x 4'-0"  | 3 x 3'-0"          | 1 x 8'-0"           | 2 x 4'-0"  | 3 x 3'-0" | 1 x 8'-0"  | 2 x 4'-6"  | 3 x 3'-6"  | 1 x 8'-6"  | 2 x 5'-0"  | 3 x 3'-8"  |
| 3.05 (10)  | 1 x 8'-0"                                 | 2 x 4'-0" | 3 x 2'-8"            | 1 x 8'-0"                   | 2 x 4'-0"          | 3 x 2'-8" | 1 x 8'-0"             | 2 x 4'-6"  | 3 x 3'-6"          | 1 x 8'-0"           | 2 x 4'-6"  | 3 x 3'-6" | 1 x 9'-0"  | 2 x 6'-0"  | 3 x 4'-6"  | 1 x 9'-6"  | 2 x 5'-8"  | 3 x 4'-4"  |
| 3.66 (12)  | 1 x 8'-0"                                 | 2 x 4'-0" | 3 x 3'-0"            | 1 x 8'-0"                   | 2 x 4'-4"          | 3 x 3'-4" | 1 x 8'-6"             | 2 x 5'-6"  | 3 x 4'-4"          | 1 x 8'-8"           | 2 x 5'-8"  | 3 x 4'-4" | 1 x 10'-6" | 2 x 7'-0"  | 3 x 5'-6"  | 1 x 11'-0" | 2 x 7'-0"  | 3 x 5'-6"  |
| 4.27 (14)  | 1 x 8'-0"                                 | 2 x 4'-6" | 3 x 4'-0"            | 1 x 8'-0"                   | 2 x 5'-0"          | 3 x 4'-0" | 1 x 10'-0"            | 2 x 6'-0"  | 3 x 4'-8"          | 1 x 10'-6"          | 2 x 7'-0"  | 3 x 5'-4" | 1 x 11'-6" | 2 x 7'-6"  | 3 x 6'-0"  | 1 x 12'-6" | 2 x 8'-4"  | 3 x 6'-6"  |
| 4.88 (16)  | 1 x 8'-0"                                 | 2 x 5'-0" | 3 x 4'-0"            | 1 x 9'-0"                   | 2 x 5'-6"          | 3 x 4'-6" | 1 x 10'-0"            | 2 x 6'-6"  | 3 x 5'-0"          | 1 x 11'-0"          | 2 x 7'-6"  | 3 x 5'-8" | 1 x 12'-0" | 2 x 8'-0"  | 3 x 6'-6"  | 1 x 14'-0" | 2 x 9'-4"  | 3 x 7'-4"  |
| <b>Main Floor Walls of Two Story Structure Supporting 2nd Story Wood Framed Walls, Floor and Roof (TYPE G)</b> |   |           |                      |                             |                    |           |                       |            |                    |                     |            |           |            |            |            |            |            |            |
|  | 6" & 8" Thick Wall                        |           | 10" & 12" Thick Wall |                             | 6" & 8" Thick Wall |           | 10" & 12" Thick Wall  |            | 6" & 8" Thick Wall |                     |            |           |            |            |            |            |            |            |
|  | Number and length of shear walls provided |           |                      |                             |                    |           |                       |            |                    |                     |            |           |            |            |            |            |            |            |
| 2.44 (8)   | 1 x 8'-0"                                 | 2 x 5'-0" | 3 x 4'-0"            | 1 x 8'-0"                   | 2 x 5'-0"          | 3 x 4'-0" | 1 x 10'-4"            | 2 x 6'-8"  | 3 x 5'-4"          | 1 x 10'-0"          | 2 x 6'-6"  | 3 x 5'-0" | 1 x 13'-0" | 2 x 8'-6"  | 3 x 6'-6"  | 1 x 13'-0" | 2 x 8'-0"  | 3 x 6'-6"  |
| 2.75 (9)   | 1 x 8'-0"                                 | 2 x 5'-0" | 3 x 4'-0"            | 1 x 8'-0"                   | 2 x 5'-0"          | 3 x 4'-0" | 1 x 10'-6"            | 2 x 6'-8"  | 3 x 5'-0"          | 1 x 11'-0"          | 2 x 7'-0"  | 3 x 5'-0" | 1 x 13'-6" | 2 x 8'-6"  | 3 x 6'-6"  | 1 x 13'-8" | 2 x 9'-0"  | 3 x 7'-0"  |
| 3.05 (10)  | 1 x 8'-8"                                 | 2 x 5'-8" | 3 x 4'-4"            | 1 x 8'-6"                   | 2 x 5'-6"          | 3 x 4'-4" | 1 x 11'-6"            | 2 x 7'-6"  | 3 x 6'-0"          | 1 x 11'-6"          | 2 x 7'-4"  | 3 x 6'-0" | 1 x 14'-4" | 2 x 9'-6"  | 3 x 7'-4"  | 1 x 14'-6" | 2 x 9'-4"  | 3 x 7'-4"  |
| 3.66 (12)  | 1 x 9'-4"                                 | 2 x 6'-4" | 3 x 5'-0"            | 1 x 9'-4"                   | 2 x 6'-4"          | 3 x 5'-0" | 1 x 12'-4"            | 2 x 8'-4"  | 3 x 6'-6"          | 1 x 12'-4"          | 2 x 8'-4"  | 3 x 6'-6" | 1 x 15'-0" | 2 x 10'-4" | 3 x 8'-0"  | 1 x 15'-0" | 2 x 10'-4" | 3 x 8'-0"  |
| 4.27 (14)  | 1 x 9'-8"                                 | 2 x 6'-6" | 3 x 5'-4"            | 1 x 10'-4"                  | 2 x 7'-0"          | 3 x 5'-4" | 1 x 12'-8"            | 2 x 8'-6"  | 3 x 7'-0"          | 1 x 13'-6"          | 2 x 9'-0"  | 3 x 7'-0" | 1 x 15'-6" | 2 x 10'-6" | 3 x 8'-6"  | 1 x 16'-4" | 2 x 11'-4" | 3 x 9'-0"  |
| 4.88 (16)  | 1 x 10'-0"                                | 2 x 7'-0" | 3 x 5'-6"            | 1 x 11'-0"                  | 2 x 7'-4"          | 3 x 5'-8" | 1 x 13'-0"            | 2 x 9'-0"  | 3 x 7'-6"          | 1 x 14'-0"          | 2 x 9'-6"  | 3 x 7'-6" | 1 x 15'-6" | 2 x 10'-6" | 3 x 8'-6"  | 1 x 17'-0" | 2 x 11'-6" | 3 x 9'-4"  |
| <b>Main Floor Walls of Two Story ICF Structure Supporting Wood Frame Floors and Roof (TYPE H)</b>              |   |           |                      |                             |                    |           |                       |            |                    |                     |            |           |            |            |            |            |            |            |
|  | 6" & 8" Thick Wall                        |           | 10" & 12" Thick Wall |                             | 6" & 8" Thick Wall |           | 10" & 12" Thick Wall  |            | 6" & 8" Thick Wall |                     |            |           |            |            |            |            |            |            |
|  | Number and length of shear walls provided |           |                      |                             |                    |           |                       |            |                    |                     |            |           |            |            |            |            |            |            |
| 2.44 (8)   | 1 x 9'-4"                                 | 2 x 6'-0" | 3 x 4'-8"            | 1 x 10'-0"                  | 2 x 6'-4"          | 3 x 5'-0" | 1 x 12'-6"            | 2 x 8'-0"  | 3 x 6'-4"          | 1 x 13'-4"          | 2 x 8'-6"  | 3 x 6'-6" | 1 x 16'-0" | 2 x 10'-0" | 3 x 8'-0"  | 1 x 16'-6" | 2 x 11'-0" | 3 x 8'-6"  |
| 2.75 (9)   | 1 x 9'-8"                                 | 2 x 6'-6" | 3 x 4'-8"            | 1 x 11'-0"                  | 2 x 6'-6"          | 3 x 5'-0" | 1 x 13'-0"            | 2 x 8'-4"  | 3 x 6'-6"          | 1 x 14'-0"          | 2 x 9'-0"  | 3 x 7'-0" | 1 x 16'-6" | 2 x 11'-0" | 3 x 8'-6"  | 1 x 17'-6" | 2 x 11'-6" | 3 x 9'-0"  |
| 3.05 (10)  | 1 x 11'-0"                                | 2 x 7'-0" | 3 x 5'-6"            | 1 x 11'-0"                  | 2 x 7'-0"          | 3 x 5'-6" | 1 x 14'-0"            | 2 x 9'-6"  | 3 x 7'-4"          | 1 x 15'-0"          | 2 x 9'-6"  | 3 x 7'-6" | 1 x 17'-6" | 2 x 11'-6" | 3 x 9'-0"  | 1 x 18'-6" | 2 x 12'-0" | 3 x 9'-6"  |
| 3.66 (12)  | 1 x 11'-6"                                | 2 x 7'-6" | 3 x 6'-0"            | 1 x 11'-6"                  | 2 x 7'-8"          | 3 x 6'-0" | 1 x 14'-6"            | 2 x 10'-0" | 3 x 7'-8"          | 1 x 15'-0"          | 2 x 10'-0" | 3 x 8'-0" | 1 x 18'-0" | 2 x 12'-4" | 3 x 9'-8"  | 1 x 19'-0" | 2 x 12'-6" | 3 x 10'-0" |
| 4.27 (14)  | 1 x 11'-6"                                | 2 x 8'-0" | 3 x 6'-6"            | 1 x 12'-6"                  | 2 x 8'-6"          | 3 x 7'-0" | 1 x 15'-0"            | 2 x 10'-0" | 3 x 8'-0"          | 1 x 16'-6"          | 2 x 11'-0" | 3 x 9'-0" | 1 x 18'-4" | 2 x 12'-6" | 3 x 10'-0" | 1 x 21'-0" | 2 x 13'-6" | 3 x 11'-0" |
| 4.88 (16)  | 1 x 11'-6"                                | 2 x 8'-0" | 3 x 6'-6"            | 1 x 13'-0"                  | 2 x 9'-0"          | 3 x 7'-0" | 1 x 15'-0"            | 2 x 10'-0" | 3 x 8'-0"          | 1 x 17'-6"          | 2 x 12'-0" | 3 x 9'-0" | 1 x 18'-4" | 2 x 12'-6" | 3 x 10'-0" | 1 x 21'-0" | 2 x 14'-4" | 3 x 11'-4" |
| Vertical Reinforcement   | ICF with 6" Tie Spacing                   |           |                      | As per table A.1.1.         |                    |           | As per table A.1.1.   |            |                    | As per table A.1.1. |            |           |            |            |            |            |            |            |
| Vertical Reinforcement   | ICF with 8" Tie Spacing                   |           |                      | As per table A.1.2.         |                    |           | As per table A.1.2.   |            |                    | As per table A.1.2. |            |           |            |            |            |            |            |            |
| Horizontal Reinforcement   | Block Height of 12" and 18"               |           |                      | 10 M @ 450 (18)             |                    |           | 10 M @ 450 (18)       |            |                    | 10 M @ 450 (18)     |            |           |            |            |            |            |            |            |
| Horizontal Reinforcement   | Block Height of 16"                       |           |                      | 10 M @ 400 (16)             |                    |           | 10 M @ 400 (16)       |            |                    | 10 M @ 400 (16)     |            |           |            |            |            |            |            |            |

**NOTES:**

1.  $S_{a,ICF}$  is equivalent spectral response acceleration for ICF walls as provided in Appendix A.
2. This table is to be used in conjunction with the "Design Limitations."
3. Provide two layers of the indicated horizontal and vertical distributed steel specified for 300mm (12") walls. Place each layer as shown in the rebar placement drawing.
4. All four sides of the building are to have a minimum number and length of shear walls that conforms to this table.
5. Use Table A.6 for buildings that do not meet the required wall length of this table.
6. Provide 2-15M concentrated reinforcement at each end of shear walls as shown in shear wall detail.
7. All concentrated reinforcement is to be continues to the bottom of the foundation wall. Provide lap splices as required.
8. Concentrated reinforcement is to be placed in accordance with Bar Placement Detail.

**INSULATING CONCRETE FORMS MANUFACTURERS ASSOCIATION**



**Table A.9.3200. Above Grade Shear Wall Length for Seismic Zone Classification,  $S_{a,ICF} \leq 0.16$  and Hourly Wind Pressure,  $0.75kPa < q_{1/50} \leq 1.05kPa$  (in a Building With Walkout Basement), where Building Area  $\leq 3200ft^2$**

| Wall Height m (ft)   | Seismic Zone Classification               |                     |                       |            |                       |           |
|--|---|---------------------|-----------------------|------------|-----------------------|-----------|
|  | $S_{a,ICF} \leq 0.07$                     |                     | $S_{a,ICF} \leq 0.11$ |            | $S_{a,ICF} \leq 0.16$ |           |
| <b>Second Floor Walls of Two Story ICF Structure Supporting Wood Frame Roof (TYPE E)</b>                       |   |                     |                       |            |                       |           |
|  | 6" & 8" Thick Wall                        |                     | 10" & 12" Thick Wall  |            | 6" & 8" Thick Wall    |           |
|  | Number and length of shear walls provided |                     |                       |            |                       |           |
| 2.44 (8)   | 1 x 8'-0"                                 | 2 x 4'-0"           | 3 x 2'-8"             | 1 x 8'-0"  | 2 x 4'-0"             | 3 x 2'-8" |
| 2.75 (9)   | 1 x 8'-0"                                 | 2 x 4'-0"           | 3 x 2'-8"             | 1 x 8'-0"  | 2 x 4'-0"             | 3 x 3'-0" |
| 3.05 (10)  | 1 x 8'-0"                                 | 2 x 4'-0"           | 3 x 2'-8"             | 1 x 8'-0"  | 2 x 4'-4"             | 3 x 3'-4" |
| 3.66 (12)  | 1 x 8'-0"                                 | 2 x 4'-0"           | 3 x 3'-0"             | 1 x 8'-0"  | 2 x 4'-6"             | 3 x 3'-6" |
| 4.27 (14)  | 1 x 8'-0"                                 | 2 x 4'-6"           | 3 x 4'-0"             | 1 x 8'-0"  | 2 x 5'-0"             | 3 x 3'-8" |
| 4.88 (16)  | 1 x 8'-0"                                 | 2 x 5'-0"           | 3 x 4'-0"             | 1 x 8'-0"  | 2 x 5'-0"             | 3 x 3'-8" |
| <b>Main Floor Walls of One Story ICF Structure Supporting Wood Frame Roof (TYPE F)</b>                         |   |                     |                       |            |                       |           |
|  | 6" & 8" Thick Wall                        |                     | 10" & 12" Thick Wall  |            | 6" & 8" Thick Wall    |           |
|  | Number and length of shear walls provided |                     |                       |            |                       |           |
| 2.44 (8)   | 1 x 8'-0"                                 | 2 x 4'-0"           | 3 x 2'-8"             | 1 x 8'-0"  | 2 x 4'-0"             | 3 x 2'-8" |
| 2.75 (9)   | 1 x 8'-0"                                 | 2 x 4'-0"           | 3 x 2'-8"             | 1 x 8'-0"  | 2 x 4'-0"             | 3 x 3'-0" |
| 3.05 (10)  | 1 x 8'-0"                                 | 2 x 4'-0"           | 3 x 2'-8"             | 1 x 8'-0"  | 2 x 4'-4"             | 3 x 3'-4" |
| 3.66 (12)  | 1 x 8'-0"                                 | 2 x 4'-0"           | 3 x 3'-0"             | 1 x 8'-0"  | 2 x 4'-6"             | 3 x 3'-6" |
| 4.27 (14)  | 1 x 8'-0"                                 | 2 x 4'-6"           | 3 x 4'-0"             | 1 x 8'-0"  | 2 x 5'-6"             | 3 x 4'-4" |
| 4.88 (16)  | 1 x 8'-0"                                 | 2 x 5'-0"           | 3 x 4'-0"             | 1 x 8'-0"  | 2 x 5'-6"             | 3 x 4'-4" |
| <b>Main Floor Walls of Two Story Structure Supporting 2nd Story Wood Framed Walls, Floor and Roof (TYPE G)</b> |   |                     |                       |            |                       |           |
|  | 6" & 8" Thick Wall                        |                     | 10" & 12" Thick Wall  |            | 6" & 8" Thick Wall    |           |
|  | Number and length of shear walls provided |                     |                       |            |                       |           |
| 2.44 (8)   | 1 x 8'-0"                                 | 2 x 5'-0"           | 3 x 4'-0"             | 1 x 8'-0"  | 2 x 5'-0"             | 3 x 4'-0" |
| 2.75 (9)   | 1 x 8'-0"                                 | 2 x 5'-0"           | 3 x 4'-0"             | 1 x 8'-4"  | 2 x 5'-4"             | 3 x 4'-0" |
| 3.05 (10)  | 1 x 8'-8"                                 | 2 x 5'-8"           | 3 x 4'-4"             | 1 x 8'-6"  | 2 x 5'-6"             | 3 x 4'-4" |
| 3.66 (12)  | 1 x 9'-4"                                 | 2 x 6'-4"           | 3 x 5'-0"             | 1 x 9'-4"  | 2 x 6'-4"             | 3 x 4'-4" |
| 4.27 (14)  | 1 x 9'-8"                                 | 2 x 6'-6"           | 3 x 5'-4"             | 1 x 10'-4" | 2 x 7'-0"             | 3 x 5'-4" |
| 4.88 (16)  | 1 x 10'-0"                                | 2 x 7'-0"           | 3 x 5'-6"             | 1 x 11'-0" | 2 x 7'-4"             | 3 x 5'-8" |
| <b>Main Floor Walls of Two Story ICF Structure Supporting Wood Frame Floors and Roof (TYPE H)</b>              |   |                     |                       |            |                       |           |
|  | 6" & 8" Thick Wall                        |                     | 10" & 12" Thick Wall  |            | 6" & 8" Thick Wall    |           |
|  | Number and length of shear walls provided |                     |                       |            |                       |           |
| 2.44 (8)   | 1 x 9'-4"                                 | 2 x 6'-0"           | 3 x 4'-8"             | 1 x 10'-0" | 2 x 6'-4"             | 3 x 5'-0" |
| 2.75 (9)   | 1 x 9'-8"                                 | 2 x 6'-6"           | 3 x 4'-8"             | 1 x 11'-0" | 2 x 7'-0"             | 3 x 5'-4" |
| 3.05 (10)  | 1 x 11'-0"                                | 2 x 7'-0"           | 3 x 5'-6"             | 1 x 11'-0" | 2 x 7'-0"             | 3 x 5'-6" |
| 3.66 (12)  | 1 x 11'-6"                                | 2 x 7'-6"           | 3 x 6'-0"             | 1 x 11'-6" | 2 x 7'-8"             | 3 x 6'-0" |
| 4.27 (14)  | 1 x 11'-6"                                | 2 x 8'-0"           | 3 x 6'-6"             | 1 x 12'-6" | 2 x 8'-6"             | 3 x 7'-0" |
| 4.88 (16)  | 1 x 11'-6"                                | 2 x 8'-0"           | 3 x 6'-6"             | 1 x 13'-0" | 2 x 9'-0"             | 3 x 7'-0" |
| Vertical Reinforcement   | ICF with 6" Tie Spacing                   | As per table A.1.1. |                       |            | As per table A.1.1.   |           |
| Vertical Reinforcement   | ICF with 8" Tie Spacing                   | As per table A.1.2. |                       |            | As per table A.1.2.   |           |
| Horizontal Reinforcement   | Block Height of 12" and 18"               | 10 M @ 450 (18)     |                       |            | 10 M @ 450 (18)       |           |
| Horizontal Reinforcement   | Block Height of 16"                       | 10 M @ 400 (16)     |                       |            | 10 M @ 400 (16)       |           |

**NOTES:**

1.  $S_{a,ICF}$  is equivalent spectral response acceleration for ICF walls as provided in Appendix A.
2. This table is to be used in conjunction with the "Design Limitations."
3. Provide two layers of the indicated horizontal and vertical distributed steel specified for 300mm (12") walls. Place each layer as shown in the rebar placement drawing.
4. All four sides of the building are to have a minimum number and length of shear walls that conforms to this table.
5. Use Table A.6 for buildings that do not meet the required wall length of this table.
6. Provide 2-15M concentrated reinforcement at each end of shear walls as shown in shear wall detail.
7. All concentrated reinforcement is to be continues to the bottom of the foundation wall. Provide lap splices as required.
8. Concentrated reinforcement is to be placed in accordance with Bar Placement Detail.

**INSULATING CONCRETE FORMS MANUFACTURERS ASSOCIATION**



**Table A.10.3200. Above Grade Shear Wall Length for Seismic Zone Classification,  $S_{a,ICF} > 0.16$  and Hourly Wind Pressure,  $q_{1/50} \leq 1.05kPa$  (in a Building With Walkout Basement), where Building Area  $\leq 3200ft^2$**

| Wall Height m (ft)  | Seismic Zone Classification               |                             |                             |                             |                             |                             |                             |                             |  |
|---|---|-----------------------------|-----------------------------|-----------------------------|-----------------------------|-----------------------------|-----------------------------|-----------------------------|--|
|   | $S_{a,ICF} \leq 0.16$                     |                             | $S_{a,ICF} \leq 0.31$       |                             | $S_{a,ICF} \leq 0.53$       |                             | $S_{a,ICF} \leq 0.79$       |                             |  |
| Second Floor Walls of Two Story ICF Structure Supporting Wood Frame Roof (TYPE E)                       |   |                             |                             |                             |                             |                             |                             |                             |  |
|   | 6" & 8" Thick Wall                        | 10" & 12" Thick Wall        | 6" & 8" Thick Wall          | 10" & 12" Thick Wall        | 6" & 8" Thick Wall          | 10" & 12" Thick Wall        | 6" & 8" Thick Wall          | 10" & 12" Thick Wall        |  |
| 2.44 (8)  | Number and length of shear walls provided |                             |                             |                             |                             |                             |                             |                             |  |
| 2.75 (9)  | 1x 8'-0" 2x 4'-0" 3x 3'-0"                | 1x 8'-0" 2x 4'-0" 3x 3'-0"  | 1x 8'-0" 2x 4'-0" 3x 3'-0"  | 1x 8'-0" 2x 4'-0" 3x 3'-0"  | 1x 8'-0" 2x 4'-0" 3x 3'-0"  | 1x 8'-0" 2x 4'-0" 3x 3'-0"  | 1x 8'-0" 2x 4'-0" 3x 3'-0"  | 1x 8'-0" 2x 4'-0" 3x 3'-0"  |  |
| 3.05 (10)   | 1x 8'-0" 2x 4'-0" 3x 3'-0"                | 1x 8'-0" 2x 4'-0" 3x 3'-0"  | 1x 8'-0" 2x 4'-0" 3x 3'-0"  | 1x 8'-0" 2x 4'-0" 3x 3'-0"  | 1x 8'-0" 2x 4'-0" 3x 3'-0"  | 1x 8'-0" 2x 4'-0" 3x 3'-0"  | 1x 8'-0" 2x 4'-0" 3x 3'-0"  | 1x 8'-0" 2x 4'-0" 3x 3'-0"  |  |
| 3.66 (12)   | 1x 8'-0" 2x 4'-0" 3x 3'-0"                | 1x 8'-0" 2x 4'-0" 3x 3'-0"  | 1x 8'-0" 2x 4'-0" 3x 3'-0"  | 1x 8'-0" 2x 4'-0" 3x 3'-0"  | 1x 8'-0" 2x 4'-0" 3x 3'-0"  | 1x 8'-0" 2x 4'-0" 3x 3'-0"  | 1x 8'-0" 2x 4'-0" 3x 3'-0"  | 1x 8'-0" 2x 4'-0" 3x 3'-0"  |  |
| 4.27 (14)   | 1x 8'-0" 2x 4'-0" 3x 3'-0"                | 1x 8'-0" 2x 4'-0" 3x 3'-0"  | 1x 8'-0" 2x 4'-0" 3x 3'-0"  | 1x 8'-0" 2x 4'-0" 3x 3'-0"  | 1x 8'-0" 2x 4'-0" 3x 3'-0"  | 1x 8'-0" 2x 4'-0" 3x 3'-0"  | 1x 8'-0" 2x 4'-0" 3x 3'-0"  | 1x 8'-0" 2x 4'-0" 3x 3'-0"  |  |
| 4.88 (16)   | 1x 8'-0" 2x 4'-0" 3x 3'-0"                | 1x 8'-0" 2x 4'-0" 3x 3'-0"  | 1x 8'-0" 2x 4'-0" 3x 3'-0"  | 1x 8'-0" 2x 4'-0" 3x 3'-0"  | 1x 8'-0" 2x 4'-0" 3x 3'-0"  | 1x 8'-0" 2x 4'-0" 3x 3'-0"  | 1x 8'-0" 2x 4'-0" 3x 3'-0"  | 1x 8'-0" 2x 4'-0" 3x 3'-0"  |  |
| Main Floor Walls of One Story ICF Structure Supporting Wood Frame Roof (TYPE F)                         |   |                             |                             |                             |                             |                             |                             |                             |  |
|   | 6" & 8" Thick Wall                        | 10" & 12" Thick Wall        | 6" & 8" Thick Wall          | 10" & 12" Thick Wall        | 6" & 8" Thick Wall          | 10" & 12" Thick Wall        | 6" & 8" Thick Wall          | 10" & 12" Thick Wall        |  |
| 2.44 (8)  | Number and length of shear walls provided |                             |                             |                             |                             |                             |                             |                             |  |
| 2.75 (9)  | 1x 8'-0" 2x 4'-0" 3x 3'-0"                | 1x 8'-0" 2x 4'-0" 3x 3'-0"  | 1x 8'-0" 2x 4'-0" 3x 3'-0"  | 1x 8'-0" 2x 4'-0" 3x 3'-0"  | 1x 8'-0" 2x 4'-0" 3x 3'-0"  | 1x 8'-0" 2x 4'-0" 3x 3'-0"  | 1x 8'-0" 2x 4'-0" 3x 3'-0"  | 1x 8'-0" 2x 4'-0" 3x 3'-0"  |  |
| 3.05 (10)   | 1x 8'-0" 2x 4'-0" 3x 3'-0"                | 1x 8'-0" 2x 4'-0" 3x 3'-0"  | 1x 8'-0" 2x 4'-0" 3x 3'-0"  | 1x 8'-0" 2x 4'-0" 3x 3'-0"  | 1x 8'-0" 2x 4'-0" 3x 3'-0"  | 1x 8'-0" 2x 4'-0" 3x 3'-0"  | 1x 8'-0" 2x 4'-0" 3x 3'-0"  | 1x 8'-0" 2x 4'-0" 3x 3'-0"  |  |
| 3.66 (12)   | 1x 8'-0" 2x 4'-0" 3x 3'-0"                | 1x 8'-0" 2x 4'-0" 3x 3'-0"  | 1x 8'-0" 2x 4'-0" 3x 3'-0"  | 1x 8'-0" 2x 4'-0" 3x 3'-0"  | 1x 8'-0" 2x 4'-0" 3x 3'-0"  | 1x 8'-0" 2x 4'-0" 3x 3'-0"  | 1x 8'-0" 2x 4'-0" 3x 3'-0"  | 1x 8'-0" 2x 4'-0" 3x 3'-0"  |  |
| 4.27 (14)   | 1x 8'-0" 2x 4'-0" 3x 3'-0"                | 1x 8'-0" 2x 4'-0" 3x 3'-0"  | 1x 8'-0" 2x 4'-0" 3x 3'-0"  | 1x 8'-0" 2x 4'-0" 3x 3'-0"  | 1x 8'-0" 2x 4'-0" 3x 3'-0"  | 1x 8'-0" 2x 4'-0" 3x 3'-0"  | 1x 8'-0" 2x 4'-0" 3x 3'-0"  | 1x 8'-0" 2x 4'-0" 3x 3'-0"  |  |
| 4.88 (16)   | 1x 8'-0" 2x 4'-0" 3x 3'-0"                | 1x 8'-0" 2x 4'-0" 3x 3'-0"  | 1x 8'-0" 2x 4'-0" 3x 3'-0"  | 1x 8'-0" 2x 4'-0" 3x 3'-0"  | 1x 8'-0" 2x 4'-0" 3x 3'-0"  | 1x 8'-0" 2x 4'-0" 3x 3'-0"  | 1x 8'-0" 2x 4'-0" 3x 3'-0"  | 1x 8'-0" 2x 4'-0" 3x 3'-0"  |  |
| Main Floor Walls of Two Story Structure Supporting 2nd Story Wood Framed Walls, Floor and Roof (TYPE G) |   |                             |                             |                             |                             |                             |                             |                             |  |
|   | 6" & 8" Thick Wall                        | 10" & 12" Thick Wall        | 6" & 8" Thick Wall          | 10" & 12" Thick Wall        | 6" & 8" Thick Wall          | 10" & 12" Thick Wall        | 6" & 8" Thick Wall          | 10" & 12" Thick Wall        |  |
| 2.44 (8)  | Number and length of shear walls provided |                             |                             |                             |                             |                             |                             |                             |  |
| 2.75 (9)  | 1x 11'-0" 2x 7'-0" 3x 6'-0"               | 1x 11'-0" 2x 7'-0" 3x 6'-0" | 1x 11'-0" 2x 7'-0" 3x 6'-0" | 1x 11'-0" 2x 7'-0" 3x 6'-0" | 1x 11'-0" 2x 7'-0" 3x 6'-0" | 1x 11'-0" 2x 7'-0" 3x 6'-0" | 1x 11'-0" 2x 7'-0" 3x 6'-0" | 1x 11'-0" 2x 7'-0" 3x 6'-0" |  |
| 3.05 (10)   | 1x 11'-0" 2x 7'-0" 3x 6'-0"               | 1x 11'-0" 2x 7'-0" 3x 6'-0" | 1x 11'-0" 2x 7'-0" 3x 6'-0" | 1x 11'-0" 2x 7'-0" 3x 6'-0" | 1x 11'-0" 2x 7'-0" 3x 6'-0" | 1x 11'-0" 2x 7'-0" 3x 6'-0" | 1x 11'-0" 2x 7'-0" 3x 6'-0" | 1x 11'-0" 2x 7'-0" 3x 6'-0" |  |
| 3.66 (12)   | 1x 11'-0" 2x 7'-0" 3x 6'-0"               | 1x 11'-0" 2x 7'-0" 3x 6'-0" | 1x 11'-0" 2x 7'-0" 3x 6'-0" | 1x 11'-0" 2x 7'-0" 3x 6'-0" | 1x 11'-0" 2x 7'-0" 3x 6'-0" | 1x 11'-0" 2x 7'-0" 3x 6'-0" | 1x 11'-0" 2x 7'-0" 3x 6'-0" | 1x 11'-0" 2x 7'-0" 3x 6'-0" |  |
| 4.27 (14)   | 1x 11'-0" 2x 7'-0" 3x 6'-0"               | 1x 11'-0" 2x 7'-0" 3x 6'-0" | 1x 11'-0" 2x 7'-0" 3x 6'-0" | 1x 11'-0" 2x 7'-0" 3x 6'-0" | 1x 11'-0" 2x 7'-0" 3x 6'-0" | 1x 11'-0" 2x 7'-0" 3x 6'-0" | 1x 11'-0" 2x 7'-0" 3x 6'-0" | 1x 11'-0" 2x 7'-0" 3x 6'-0" |  |
| 4.88 (16)   | 1x 11'-0" 2x 7'-0" 3x 6'-0"               | 1x 11'-0" 2x 7'-0" 3x 6'-0" | 1x 11'-0" 2x 7'-0" 3x 6'-0" | 1x 11'-0" 2x 7'-0" 3x 6'-0" | 1x 11'-0" 2x 7'-0" 3x 6'-0" | 1x 11'-0" 2x 7'-0" 3x 6'-0" | 1x 11'-0" 2x 7'-0" 3x 6'-0" | 1x 11'-0" 2x 7'-0" 3x 6'-0" |  |
| Main Floor Walls of Two Story ICF Structure Supporting Wood Frame Floors and Roof (TYPE H)              |   |                             |                             |                             |                             |                             |                             |                             |  |
|   | 6" & 8" Thick Wall                        | 10" & 12" Thick Wall        | 6" & 8" Thick Wall          | 10" & 12" Thick Wall        | 6" & 8" Thick Wall          | 10" & 12" Thick Wall        | 6" & 8" Thick Wall          | 10" & 12" Thick Wall        |  |
| 2.44 (8)  | Number and length of shear walls provided |                             |                             |                             |                             |                             |                             |                             |  |
| 2.75 (9)  | 1x 13'-0" 2x 9'-0" 3x 7'-0"               | 1x 13'-0" 2x 9'-0" 3x 7'-0" | 1x 13'-0" 2x 9'-0" 3x 7'-0" | 1x 13'-0" 2x 9'-0" 3x 7'-0" | 1x 13'-0" 2x 9'-0" 3x 7'-0" | 1x 13'-0" 2x 9'-0" 3x 7'-0" | 1x 13'-0" 2x 9'-0" 3x 7'-0" | 1x 13'-0" 2x 9'-0" 3x 7'-0" |  |
| 3.05 (10)   | 1x 13'-0" 2x 9'-0" 3x 7'-0"               | 1x 13'-0" 2x 9'-0" 3x 7'-0" | 1x 13'-0" 2x 9'-0" 3x 7'-0" | 1x 13'-0" 2x 9'-0" 3x 7'-0" | 1x 13'-0" 2x 9'-0" 3x 7'-0" | 1x 13'-0" 2x 9'-0" 3x 7'-0" | 1x 13'-0" 2x 9'-0" 3x 7'-0" | 1x 13'-0" 2x 9'-0" 3x 7'-0" |  |
| 3.66 (12)   | 1x 13'-0" 2x 9'-0" 3x 7'-0"               | 1x 13'-0" 2x 9'-0" 3x 7'-0" | 1x 13'-0" 2x 9'-0" 3x 7'-0" | 1x 13'-0" 2x 9'-0" 3x 7'-0" | 1x 13'-0" 2x 9'-0" 3x 7'-0" | 1x 13'-0" 2x 9'-0" 3x 7'-0" | 1x 13'-0" 2x 9'-0" 3x 7'-0" | 1x 13'-0" 2x 9'-0" 3x 7'-0" |  |
| 4.27 (14)   | 1x 13'-0" 2x 9'-0" 3x 7'-0"               | 1x 13'-0" 2x 9'-0" 3x 7'-0" | 1x 13'-0" 2x 9'-0" 3x 7'-0" | 1x 13'-0" 2x 9'-0" 3x 7'-0" | 1x 13'-0" 2x 9'-0" 3x 7'-0" | 1x 13'-0" 2x 9'-0" 3x 7'-0" | 1x 13'-0" 2x 9'-0" 3x 7'-0" | 1x 13'-0" 2x 9'-0" 3x 7'-0" |  |
| 4.88 (16)   | 1x 13'-0" 2x 9'-0" 3x 7'-0"               | 1x 13'-0" 2x 9'-0" 3x 7'-0" | 1x 13'-0" 2x 9'-0" 3x 7'-0" | 1x 13'-0" 2x 9'-0" 3x 7'-0" | 1x 13'-0" 2x 9'-0" 3x 7'-0" | 1x 13'-0" 2x 9'-0" 3x 7'-0" | 1x 13'-0" 2x 9'-0" 3x 7'-0" | 1x 13'-0" 2x 9'-0" 3x 7'-0" |  |
| Vertical Reinforcement  |   | ICF with 6" Tie Spacing     |                             | As per table A.2.1          |                             | ICF with 8" Tie Spacing     |                             | As per table A.2.2          |  |
| Horizontal Reinforcement  |   | Block Height of 12" and 18" |                             | As per table A.2.1          |                             | Block Height of 10"         |                             | As per table A.2.2          |  |

**NOTES:**

1.  $S_{a,ICF}$  is equivalent spectral response acceleration for ICF walls as provided in Appendix A.
2. This table is to be used in conjunction with the "Design Limitations."
3. Provide two layers of the indicated horizontal and vertical distributed steel specified for 300mm (12") walls. Place each layer as shown in the rebar placement drawing.
4. All four sides of the building are to have a minimum number and length of shear walls that conforms to this table.
5. Provide 2-15M concentrated reinforcement at each end of shear walls as shown in shear wall detail.
6. All concentrated reinforcement is to be continues to the bottom of the foundation wall. Provide lap splices as required.
7. Concentrated reinforcement is to be placed in accordance with Bar Placement Detail.
8. Horizontal reinforcement in shear walls where  $S_{a,ICF} > 0.16$  must be anchored using a standard 180° hook around vertical end bars.
9. When using this table for  $S_{a,ICF} \leq 0.16$ , use the vertical and horizontal distributed steel in Tables A.2.1. or A.2.2.

# INSULATING CONCRETE FORMS MANUFACTURERS ASSOCIATION

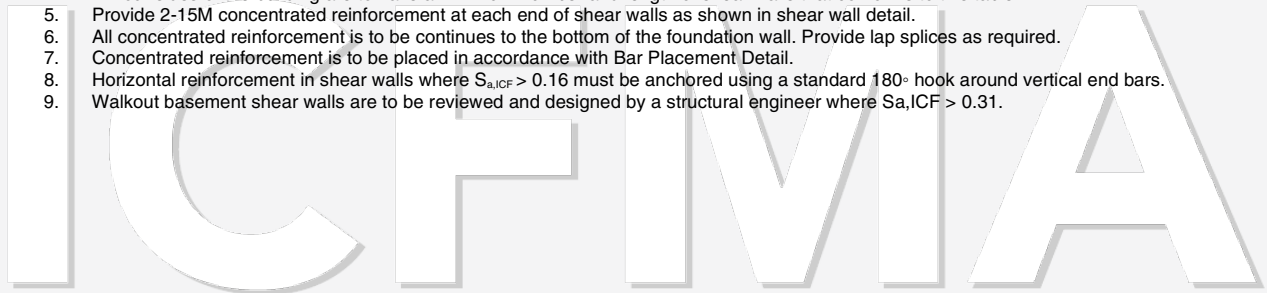

**Table A. 11.3200. – Above Grade Walkout Basement Shear Wall Length for Seismic Zone Classification,  $S_{a,ICF} \leq 0.31$  and Hourly Wind Pressure,  $q/50 \leq 1.05kPa$ , where Building Area  $\leq 3200ft^2$**

| Wall Height m (ft)  | Seismic Zone Classification               |                          |                           |                           |                           |                            |                            |                            |                            |
|---|---|--------------------------|---------------------------|---------------------------|---------------------------|----------------------------|----------------------------|----------------------------|----------------------------|
|   | $S_{a,ICF} \leq 0.07$                     |                          | $S_{a,ICF} \leq 0.11$     |                           | $S_{a,ICF} \leq 0.16$     |                            | $S_{a,ICF} \leq 0.31$      |                            |                            |
| <b>Walkout Basement Wall of a Single Story ICF Structure Supporting Wood Framed Roof (TYPE W1)</b>  |   |                          |                           |                           |                           |                            |                            |                            |                            |
|   | 6" & 8" Thick Wall                        | 10" & 12" Thick Wall     | 6" & 8" Thick Wall        | 10" & 12" Thick Wall      | 6" & 8" Thick Wall        | 10" & 12" Thick Wall       | 6" & 8" Thick Wall         | 10" & 12" Thick Wall       |                            |
|   | Number and length of shear walls provided |                          |                           |                           |                           |                            |                            |                            |                            |
| 2.44 (8)  | 1x8'-0" 2x5'-6" 3x4'-6"                   | 1x8'-6" 2x6'-0" 3x4'-6"  | 1x10'-0" 2x7'-0" 3x5'-6"  | 1x10'-6" 2x7'-6" 3x6'-0"  | 1x10'-6" 2x7'-6" 3x6'-0"  | 1x12'-6" 2x8'-6" 3x7'-0"   | 1x13'-0" 2x9'-0" 3x7'-0"   | 1x18'-0" 2x12'-6" 3x10'-0" | 1x19'-0" 2x13'-0" 3x10'-0" |
| 2.75 (9)  | 1x8'-0" 2x5'-6" 3x4'-6"                   | 1x9'-0" 2x6'-0" 3x5'-0"  | 1x10'-6" 2x7'-0" 3x6'-0"  | 1x11'-0" 2x7'-6" 3x6'-0"  | 1x11'-0" 2x7'-6" 3x6'-0"  | 1x12'-6" 2x9'-0" 3x7'-0"   | 1x13'-4" 2x9'-4" 3x7'-4"   | 1x18'-0" 2x12'-6" 3x10'-0" | 1x19'-0" 2x13'-0" 3x10'-0" |
| 3.05 (10)   | 1x8'-6" 2x6'-0" 3x4'-6"                   | 1x9'-0" 2x6'-0" 3x5'-0"  | 1x10'-6" 2x7'-6" 3x6'-0"  | 1x10'-6" 2x7'-6" 3x6'-0"  | 1x11'-0" 2x7'-6" 3x6'-0"  | 1x13'-0" 2x9'-0" 3x7'-6"   | 1x13'-6" 2x9'-6" 3x7'-6"   | 1x18'-6" 2x13'-0" 3x10'-6" | 1x19'-6" 2x13'-6" 3x11'-0" |
| 3.66 (12)   | 1x9'-0" 2x6'-0" 3x5'-0"                   | 1x10'-0" 2x6'-0" 3x5'-0" | 1x11'-4" 2x8'-0" 3x6'-0"  | 1x12'-0" 2x8'-0" 3x6'-0"  | 1x12'-0" 2x8'-0" 3x6'-0"  | 1x13'-6" 2x9'-6" 3x8'-0"   | 1x14'-6" 2x10'-0" 3x8'-0"  | 1x19'-6" 2x13'-6" 3x11'-0" | 1x21'-0" 2x14'-0" 3x11'-6" |
| <b>Walkout Basement Walls of a Two Story Wood Framed Structure Supporting Wood Frame Floors and Roof (TYPE W2)</b>                              |   |                          |                           |                           |                           |                            |                            |                            |                            |
|   | 6" & 8" Thick Wall                        | 10" & 12" Thick Wall     | 6" & 8" Thick Wall        | 10" & 12" Thick Wall      | 6" & 8" Thick Wall        | 10" & 12" Thick Wall       | 6" & 8" Thick Wall         | 10" & 12" Thick Wall       |                            |
|   | Number and length of shear walls provided |                          |                           |                           |                           |                            |                            |                            |                            |
| 2.44 (8)  | 1x9'-0" 2x6'-6" 3x5'-0"                   | 1x9'-6" 2x6'-6" 3x5'-0"  | 1x10'-6" 2x7'-6" 3x6'-0"  | 1x10'-6" 2x7'-6" 3x6'-0"  | 1x10'-6" 2x7'-6" 3x6'-0"  | 1x13'-0" 2x9'-0" 3x7'-0"   | 1x13'-0" 2x9'-0" 3x7'-0"   | 1x18'-0" 2x12'-6" 3x10'-0" | 1x18'-0" 2x12'-6" 3x10'-0" |
| 2.75 (9)  | 1x9'-6" 2x6'-6" 3x5'-6"                   | 1x9'-6" 2x6'-6" 3x5'-6"  | 1x11'-0" 2x8'-0" 3x6'-0"  | 1x11'-0" 2x8'-0" 3x6'-0"  | 1x11'-0" 2x8'-0" 3x6'-0"  | 1x13'-0" 2x9'-4" 3x7'-4"   | 1x13'-0" 2x9'-4" 3x7'-4"   | 1x18'-6" 2x13'-0" 3x10'-4" | 1x18'-6" 2x13'-0" 3x10'-4" |
| 3.05 (10)   | 1x10'-0" 2x7'-0" 3x5'-6"                  | 1x10'-0" 2x7'-0" 3x5'-6" | 1x11'-6" 2x8'-0" 3x6'-0"  | 1x11'-6" 2x8'-0" 3x6'-0"  | 1x11'-6" 2x8'-0" 3x6'-0"  | 1x13'-6" 2x9'-4" 3x7'-4"   | 1x13'-6" 2x9'-4" 3x7'-4"   | 1x19'-0" 2x13'-4" 3x10'-6" | 1x19'-0" 2x13'-4" 3x10'-6" |
| 3.66 (12)   | 1x10'-6" 2x7'-0" 3x5'-6"                  | 1x10'-6" 2x7'-0" 3x5'-6" | 1x11'-6" 2x8'-0" 3x6'-6"  | 1x11'-6" 2x8'-0" 3x6'-6"  | 1x11'-6" 2x8'-0" 3x6'-6"  | 1x14'-0" 2x9'-6" 3x7'-8"   | 1x14'-0" 2x9'-6" 3x7'-8"   | 1x19'-6" 2x13'-6" 3x11'-0" | 1x19'-6" 2x13'-6" 3x11'-0" |
| <b>Walkout Basement Wall of a Two Story Building with Main Floor ICF Walls Supporting 2nd Story Wood Framed Walls, Floor and Roof (TYPE W3)</b> |   |                          |                           |                           |                           |                            |                            |                            |                            |
|   | 6" & 8" Thick Wall                        | 10" & 12" Thick Wall     | 6" & 8" Thick Wall        | 10" & 12" Thick Wall      | 6" & 8" Thick Wall        | 10" & 12" Thick Wall       | 6" & 8" Thick Wall         | 10" & 12" Thick Wall       |                            |
|   | Number and length of shear walls provided |                          |                           |                           |                           |                            |                            |                            |                            |
| 2.44 (8)  | 1x10'-0" 2x7'-0" 3x5'-8"                  | 1x10'-0" 2x7'-4" 3x5'-8" | 1x12'-6" 2x8'-6" 3x7'-0"  | 1x12'-6" 2x8'-6" 3x7'-0"  | 1x12'-6" 2x8'-6" 3x7'-0"  | 1x15'-0" 2x10'-6" 3x8'-8"  | 1x15'-6" 2x10'-6" 3x8'-8"  | 1x21'-0" 2x15'-0" 3x12'-0" | 1x22'-0" 2x15'-0" 3x12'-0" |
| 2.75 (9)  | 1x10'-0" 2x7'-4" 3x5'-8"                  | 1x10'-0" 2x7'-4" 3x5'-8" | 1x12'-6" 2x9'-0" 3x7'-0"  | 1x13'-0" 2x9'-0" 3x7'-0"  | 1x13'-0" 2x9'-0" 3x7'-0"  | 1x16'-0" 2x10'-6" 3x8'-8"  | 1x16'-0" 2x11'-0" 3x8'-8"  | 1x21'-6" 2x15'-0" 3x12'-4" | 1x22'-0" 2x15'-6" 3x12'-4" |
| 3.05 (10)   | 1x10'-0" 2x7'-4" 3x5'-8"                  | 1x10'-6" 2x7'-4" 3x5'-8" | 1x13'-0" 2x9'-0" 3x7'-4"  | 1x13'-0" 2x9'-0" 3x7'-4"  | 1x13'-0" 2x9'-0" 3x7'-4"  | 1x16'-0" 2x11'-0" 3x8'-8"  | 1x16'-0" 2x11'-0" 3x8'-8"  | 1x22'-0" 2x15'-0" 3x12'-4" | 1x22'-6" 2x15'-6" 3x12'-6" |
| 3.66 (12)   | 1x11'-0" 2x7'-4" 3x6'-0"                  | 1x11'-0" 2x7'-4" 3x6'-0" | 1x13'-6" 2x9'-6" 3x7'-6"  | 1x13'-6" 2x9'-6" 3x7'-6"  | 1x13'-6" 2x9'-6" 3x7'-6"  | 1x16'-4" 2x11'-4" 3x9'-0"  | 1x16'-6" 2x11'-6" 3x9'-4"  | 1x23'-0" 2x16'-0" 3x13'-0" | 1x23'-6" 2x16'-6" 3x13'-0" |
| <b>Walkout Basement Wall of Two Story ICF Structure Supporting Wood Frame Floors and Roof (TYPE W4)</b>   |   |                          |                           |                           |                           |                            |                            |                            |                            |
|   | 6" & 8" Thick Wall                        | 10" & 12" Thick Wall     | 6" & 8" Thick Wall        | 10" & 12" Thick Wall      | 6" & 8" Thick Wall        | 10" & 12" Thick Wall       | 6" & 8" Thick Wall         | 10" & 12" Thick Wall       |                            |
|   | Number and length of shear walls provided |                          |                           |                           |                           |                            |                            |                            |                            |
| 2.44 (8)  | 1x11'-0" 2x7'-6" 3x6'-4"                  | 1x12'-0" 2x8'-0" 3x6'-4" | 1x14'-0" 2x10'-0" 3x8'-0" | 1x14'-6" 2x10'-6" 3x8'-0" | 1x14'-6" 2x10'-6" 3x8'-0" | 1x17'-0" 2x12'-0" 3x9'-6"  | 1x18'-0" 2x12'-6" 3x10'-0" | 1x24'-0" 2x17'-0" 3x13'-6" | 1x25'-0" 2x18'-0" 3x14'-0" |
| 2.75 (9)  | 1x11'-6" 2x8'-0" 3x6'-4"                  | 1x12'-0" 2x8'-0" 3x6'-4" | 1x15'-0" 2x10'-0" 3x8'-0" | 1x15'-0" 2x10'-6" 3x8'-6" | 1x15'-0" 2x10'-6" 3x8'-6" | 1x18'-0" 2x12'-0" 3x10'-0" | 1x18'-0" 2x12'-6" 3x10'-0" | 1x25'-0" 2x17'-0" 3x14'-0" | 1x26'-0" 2x18'-0" 3x14'-6" |
| 3.05 (10)   | 1x11'-6" 2x8'-0" 3x6'-4"                  | 1x12'-0" 2x8'-4" 3x6'-6" | 1x15'-0" 2x10'-0" 3x8'-6" | 1x15'-0" 2x10'-6" 3x8'-6" | 1x15'-0" 2x10'-6" 3x8'-6" | 1x18'-0" 2x12'-6" 3x10'-6" | 1x18'-6" 2x13'-0" 3x10'-6" | 1x25'-0" 2x18'-0" 3x14'-6" | 1x26'-0" 2x18'-0" 3x15'-0" |
| 3.66 (12)   | 1x12'-0" 2x8'-4" 3x6'-8"                  | 1x12'-6" 2x8'-6" 3x7'-0" | 1x15'-0" 2x10'-0" 3x8'-6" | 1x16'-0" 2x11'-0" 3x9'-0" | 1x16'-0" 2x11'-0" 3x9'-0" | 1x18'-6" 2x13'-0" 3x10'-6" | 1x19'-6" 2x13'-6" 3x11'-0" | 1x26'-0" 2x18'-0" 3x14'-6" | 1x27'-0" 2x19'-0" 3x15'-6" |
| Vertical Reinforcement  | 6", 8" and 10" thick wall                 | 15 M @ 300 (12)          | 10 M @ 300 (12)           | 15 M @ 300 (12)           | 15 M @ 300 (12)           | 15 M @ 300 (12)            | 15 M @ 300 (12)            | 15 M @ 300 (12)            | 15 M @ 300 (12)            |
| Horizontal Reinforcement  | 12" thick wall                            | 10 M @ 300 (12)          | 10 M @ 300 (12)           | 10 M @ 300 (12)           | 10 M @ 300 (12)           | 10 M @ 300 (12)            | 10 M @ 300 (12)            | 10 M @ 300 (12)            | 10 M @ 300 (12)            |
|   | Block Height of 12" and 18"               | 10 M @ 450 (18)          | 10 M @ 450 (18)           | 10 M @ 450 (18)           | 10 M @ 450 (18)           | 10 M @ 450 (18)            | 10 M @ 450 (18)            | 10 M @ 450 (18)            | 10 M @ 450 (18)            |
|   | Block Height of 16"                       | 10 M @ 400 (16)          | 10 M @ 400 (16)           | 10 M @ 400 (16)           | 10 M @ 400 (16)           | 10 M @ 400 (16)            | 10 M @ 400 (16)            | 10 M @ 400 (16)            | 10 M @ 400 (16)            |

**NOTES:**

1.  $S_{a,ICF}$  is equivalent spectral response acceleration for ICF walls as provided in Appendix A.
2. This table is to be used in conjunction with the "Design Limitations."
3. Provide two layers of the indicated horizontal and vertical distributed steel specified for 300mm (12") walls. Place each layer as shown in the rebar placement drawing.
4. All four sides of the building are to have a minimum number and length of shear walls that conforms to this table.
5. Provide 2-15M concentrated reinforcement at each end of shear walls as shown in shear wall detail.
6. All concentrated reinforcement is to be continues to the bottom of the foundation wall. Provide lap splices as required.
7. Concentrated reinforcement is to be placed in accordance with Bar Placement Detail.
8. Horizontal reinforcement in shear walls where  $S_{a,ICF} > 0.16$  must be anchored using a standard 180° hook around vertical end bars.
9. Walkout basement shear walls are to be reviewed and designed by a structural engineer where  $S_{a,ICF} > 0.31$ .



# INSULATING CONCRETE FORMS MANUFACTURERS ASSOCIATION



**Table A.3.2400. Above Grade Shear Wall Length for Seismic Zone Classification,  $S_{a,ICF} \leq 0.16$  and Hourly Wind Pressure,  $q_{1/50} \leq 0.5kPa$  (in a Building Without Walkout Basement), where Building Area  $\leq 2400ft^2$**

| Wall Height m (ft)   | Seismic Zone Classification               |                     |                       |                     |                       |                     |
|--|---|---------------------|-----------------------|---------------------|-----------------------|---------------------|
|  | $S_{a,ICF} \leq 0.07$                     |                     | $S_{a,ICF} \leq 0.11$ |                     | $S_{a,ICF} \leq 0.16$ |                     |
| <b>Second Floor Walls of Two Story ICF Structure Supporting Wood Frame Roof (TYPE A)</b>                       |   |                     |                       |                     |                       |                     |
|  | 6" & 8" Thick Wall                        |                     | 10" & 12" Thick Wall  |                     | 6" & 8" Thick Wall    |                     |
|  | Number and length of shear walls provided |                     |                       |                     |                       |                     |
| 2.44 (8)   | 1 x 7'-4"                                 | 2 x 3'-8"           | 3 x 2'-8"             | 1 x 7'-4"           | 2 x 3'-8"             | 3 x 2'-8"           |
| 2.75 (9)   | 1 x 7'-4"                                 | 2 x 3'-8"           | 3 x 2'-8"             | 1 x 7'-4"           | 2 x 3'-8"             | 3 x 2'-9"           |
| 3.05 (10)  | 1 x 7'-4"                                 | 2 x 3'-8"           | 3 x 2'-8"             | 1 x 7'-4"           | 2 x 3'-8"             | 3 x 2'-9"           |
|  | 6" & 8" Thick Wall                        |                     | 10" & 12" Thick Wall  |                     | 6" & 8" Thick Wall    |                     |
|  | Number and length of shear walls provided |                     |                       |                     |                       |                     |
| 2.44 (8)   | 1 x 7'-4"                                 | 2 x 3'-8"           | 3 x 2'-8"             | 1 x 7'-4"           | 2 x 3'-8"             | 3 x 2'-9"           |
| 2.75 (9)   | 1 x 7'-4"                                 | 2 x 3'-8"           | 3 x 2'-8"             | 1 x 7'-4"           | 2 x 3'-8"             | 3 x 2'-9"           |
| 3.05 (10)  | 1 x 7'-4"                                 | 2 x 3'-8"           | 3 x 2'-8"             | 1 x 7'-4"           | 2 x 3'-8"             | 3 x 2'-9"           |
| 3.66 (12)  | 1 x 7'-4"                                 | 2 x 3'-8"           | 3 x 2'-9"             | 1 x 7'-4"           | 2 x 3'-8"             | 3 x 2'-9"           |
| 4.27 (14)  | 1 x 7'-4"                                 | 2 x 3'-8"           | 3 x 2'-9"             | 1 x 7'-4"           | 2 x 3'-8"             | 3 x 2'-9"           |
| 4.88 (16)  | 1 x 7'-4"                                 | 2 x 3'-8"           | 3 x 2'-9"             | 1 x 7'-4"           | 2 x 3'-8"             | 3 x 2'-9"           |
| <b>Main Floor Walls of One Story ICF Structure Supporting Wood Frame Roof (TYPE B)</b>                         |   |                     |                       |                     |                       |                     |
|  | 6" & 8" Thick Wall                        |                     | 10" & 12" Thick Wall  |                     | 6" & 8" Thick Wall    |                     |
|  | Number and length of shear walls provided |                     |                       |                     |                       |                     |
| 2.44 (8)   | 1 x 7'-4"                                 | 2 x 3'-8"           | 3 x 2'-8"             | 1 x 7'-4"           | 2 x 3'-8"             | 3 x 2'-9"           |
| 2.75 (9)   | 1 x 7'-4"                                 | 2 x 3'-8"           | 3 x 2'-8"             | 1 x 7'-4"           | 2 x 3'-8"             | 3 x 2'-9"           |
| 3.05 (10)  | 1 x 7'-4"                                 | 2 x 3'-8"           | 3 x 2'-8"             | 1 x 7'-4"           | 2 x 3'-8"             | 3 x 2'-9"           |
| 3.66 (12)  | 1 x 7'-4"                                 | 2 x 3'-8"           | 3 x 2'-9"             | 1 x 7'-4"           | 2 x 3'-8"             | 3 x 2'-9"           |
| 4.27 (14)  | 1 x 7'-4"                                 | 2 x 3'-8"           | 3 x 2'-9"             | 1 x 7'-4"           | 2 x 3'-8"             | 3 x 2'-9"           |
| 4.88 (16)  | 1 x 7'-4"                                 | 2 x 3'-8"           | 3 x 2'-9"             | 1 x 7'-4"           | 2 x 3'-8"             | 3 x 2'-9"           |
| <b>Main Floor Walls of Two Story Structure Supporting 2nd Story Wood Framed Walls, Floor and Roof (TYPE C)</b> |   |                     |                       |                     |                       |                     |
|  | 6" & 8" Thick Wall                        |                     | 10" & 12" Thick Wall  |                     | 6" & 8" Thick Wall    |                     |
|  | Number and length of shear walls provided |                     |                       |                     |                       |                     |
| 2.44 (8)   | 1 x 7'-4"                                 | 2 x 3'-8"           | 3 x 2'-9"             | 1 x 7'-4"           | 2 x 3'-8"             | 3 x 2'-9"           |
| 2.75 (9)   | 1 x 7'-4"                                 | 2 x 4'-2"           | 3 x 3'-3"             | 1 x 7'-4"           | 2 x 3'-8"             | 3 x 2'-9"           |
| 3.05 (10)  | 1 x 7'-4"                                 | 2 x 4'-2"           | 3 x 3'-3"             | 1 x 7'-4"           | 2 x 3'-8"             | 3 x 2'-9"           |
| 3.66 (12)  | 1 x 7'-10"                                | 2 x 5'-1"           | 3 x 3'-8"             | 1 x 7'-10"          | 2 x 5'-1"             | 3 x 3'-8"           |
| 4.27 (14)  | 1 x 7'-10"                                | 2 x 5'-1"           | 3 x 4'-2"             | 1 x 7'-10"          | 2 x 5'-1"             | 3 x 3'-8"           |
| 4.88 (16)  | 1 x 7'-10"                                | 2 x 5'-1"           | 3 x 4'-2"             | 1 x 7'-10"          | 2 x 5'-1"             | 3 x 4'-2"           |
| <b>Main Floor Walls of Two Story ICF Structure Supporting Wood Frame Floors and Roof (TYPE D)</b>              |   |                     |                       |                     |                       |                     |
|  | 6" & 8" Thick Wall                        |                     | 10" & 12" Thick Wall  |                     | 6" & 8" Thick Wall    |                     |
|  | Number and length of shear walls provided |                     |                       |                     |                       |                     |
| 2.44 (8)   | 1 x 8'-3"                                 | 2 x 5'-1"           | 3 x 3'-8"             | 1 x 8'-3"           | 2 x 5'-1"             | 3 x 4'-2"           |
| 2.75 (9)   | 1 x 8'-3"                                 | 2 x 5'-6"           | 3 x 3'-8"             | 1 x 8'-3"           | 2 x 5'-12"            | 3 x 4'-7"           |
| 3.05 (10)  | 1 x 8'-9"                                 | 2 x 5'-6"           | 3 x 4'-2"             | 1 x 8'-9"           | 2 x 6'-9"             | 3 x 5'-6"           |
| 3.66 (12)  | 1 x 9'-2"                                 | 2 x 6'-5"           | 3 x 4'-7"             | 1 x 9'-2"           | 2 x 6'-9"             | 3 x 5'-6"           |
| 4.27 (14)  | 1 x 9'-2"                                 | 2 x 6'-5"           | 3 x 5'-1"             | 1 x 9'-8"           | 2 x 7'-8"             | 3 x 5'-12"          |
| 4.88 (16)  | 1 x 9'-2"                                 | 2 x 6'-5"           | 3 x 5'-1"             | 1 x 10'-1"          | 2 x 7'-10"            | 3 x 6'-5"           |
| Vertical Reinforcement   | ICF with 6" Tie Spacing                   | As per table A.1.1. |                       | As per table A.1.1. |                       | As per table A.1.1. |
| Horizontal Reinforcement   | ICF with 8" Tie Spacing                   | As per table A.1.2. |                       | As per table A.1.2. |                       | As per table A.1.2. |
|  | Block Height of 12" and 18"               | 10 M @              | 450 (18)              | 10 M @              | 450 (18)              | 10 M @ 450 (18)     |
|  | Block Height of 16"                       | 10 M @              | 400 (16)              | 10 M @              | 400 (16)              | 10 M @ 400 (16)     |

**NOTES:**

- $S_{a,ICF}$  is equivalent spectral response acceleration for ICF walls as provided in Appendix A.
- This table is to be used in conjunction with the "Design Limitations."
- Provide two layers of the indicated horizontal and vertical distributed steel specified for 300mm (12") walls. Place each layer as shown in the rebar placement drawing.
- All four sides of the building are to have a minimum number and length of shear walls that conforms to this table.
- Use Table A.6 for buildings that do not meet the required wall length of this table.
- Provide 2-15M concentrated reinforcement at each end of shear walls as shown in shear wall detail.
- All concentrated reinforcement is to be continues to the bottom of the foundation wall. Provide lap splices as required.
- Concentrated reinforcement is to be placed in accordance with Bar Placement Detail.

**INSULATING CONCRETE FORMS MANUFACTURERS ASSOCIATION**



**Table A.4.2400. Above Grade Shear Wall Length for Seismic Zone Classification,  $S_{a,ICF} \leq 0.16$  and Hourly Wind Pressure,  $0.5kPa < q1/50 \leq 0.75kPa$  (in a Building Without Walkout Basement), where Building Area  $\leq 2400ft^2$**

| Wall Height m (ft)   | Seismic Zone Classification               |                     |                       |                     |                       |                     |
|--|---|---------------------|-----------------------|---------------------|-----------------------|---------------------|
|  | $S_{a,ICF} \leq 0.07$                     |                     | $S_{a,ICF} \leq 0.11$ |                     | $S_{a,ICF} \leq 0.16$ |                     |
| <b>Second Floor Walls of Two Story ICF Structure Supporting Wood Frame Roof (TYPE A)</b>                       |   |                     |                       |                     |                       |                     |
|  | 6" & 8" Thick Wall                        |                     | 10" & 12" Thick Wall  |                     | 6" & 8" Thick Wall    |                     |
|  | Number and length of shear walls provided |                     |                       |                     |                       |                     |
| 2.44 (8)   | 1 x 7'-4"                                 | 2 x 3'-8"           | 3 x 2'-8"             | 1 x 7'-4"           | 2 x 3'-8"             | 3 x 2'-8"           |
| 2.75 (9)   | 1 x 7'-4"                                 | 2 x 3'-8"           | 3 x 2'-8"             | 1 x 7'-4"           | 2 x 3'-8"             | 3 x 2'-9"           |
| 3.05 (10)  | 1 x 7'-4"                                 | 2 x 3'-8"           | 3 x 2'-8"             | 1 x 7'-4"           | 2 x 4'-2"             | 3 x 3'-3"           |
| 3.05 (10)  | 1 x 7'-4"                                 | 2 x 3'-8"           | 3 x 2'-8"             | 1 x 7'-4"           | 2 x 4'-2"             | 3 x 3'-3"           |
| 3.05 (10)  | 1 x 7'-4"                                 | 2 x 3'-8"           | 3 x 2'-8"             | 1 x 7'-4"           | 2 x 4'-2"             | 3 x 3'-3"           |
| 3.66 (12)  | 1 x 7'-4"                                 | 2 x 3'-8"           | 3 x 2'-9"             | 1 x 7'-4"           | 2 x 4'-2"             | 3 x 3'-3"           |
| 4.27 (14)  | 1 x 7'-4"                                 | 2 x 3'-8"           | 3 x 2'-9"             | 1 x 7'-4"           | 2 x 5'-1"             | 3 x 3'-8"           |
| 4.88 (16)  | 1 x 7'-4"                                 | 2 x 3'-8"           | 3 x 2'-9"             | 1 x 7'-4"           | 2 x 5'-1"             | 3 x 3'-8"           |
| <b>Main Floor Walls of One Story ICF Structure Supporting Wood Frame Roof (TYPE B)</b>                         |   |                     |                       |                     |                       |                     |
|  | 6" & 8" Thick Wall                        |                     | 10" & 12" Thick Wall  |                     | 6" & 8" Thick Wall    |                     |
|  | Number and length of shear walls provided |                     |                       |                     |                       |                     |
| 2.44 (8)   | 1 x 7'-4"                                 | 2 x 3'-8"           | 3 x 2'-8"             | 1 x 7'-4"           | 2 x 3'-8"             | 3 x 2'-9"           |
| 2.75 (9)   | 1 x 7'-4"                                 | 2 x 3'-8"           | 3 x 2'-8"             | 1 x 7'-4"           | 2 x 3'-8"             | 3 x 2'-9"           |
| 3.05 (10)  | 1 x 7'-4"                                 | 2 x 3'-8"           | 3 x 2'-8"             | 1 x 7'-4"           | 2 x 3'-8"             | 3 x 2'-9"           |
| 3.05 (10)  | 1 x 7'-4"                                 | 2 x 3'-8"           | 3 x 2'-8"             | 1 x 7'-4"           | 2 x 4'-2"             | 3 x 3'-3"           |
| 3.66 (12)  | 1 x 7'-4"                                 | 2 x 3'-8"           | 3 x 2'-9"             | 1 x 7'-4"           | 2 x 4'-2"             | 3 x 3'-3"           |
| 4.27 (14)  | 1 x 7'-4"                                 | 2 x 3'-8"           | 3 x 2'-9"             | 1 x 7'-4"           | 2 x 4'-2"             | 3 x 3'-8"           |
| 4.88 (16)  | 1 x 7'-4"                                 | 2 x 3'-8"           | 3 x 2'-9"             | 1 x 7'-4"           | 2 x 4'-2"             | 3 x 3'-8"           |
| <b>Main Floor Walls of Two Story Structure Supporting 2nd Story Wood Framed Walls, Floor and Roof (TYPE C)</b> |   |                     |                       |                     |                       |                     |
|  | 6" & 8" Thick Wall                        |                     | 10" & 12" Thick Wall  |                     | 6" & 8" Thick Wall    |                     |
|  | Number and length of shear walls provided |                     |                       |                     |                       |                     |
| 2.44 (8)   | 1 x 7'-4"                                 | 2 x 4'-2"           | 3 x 3'-3"             | 1 x 7'-4"           | 2 x 3'-8"             | 3 x 2'-9"           |
| 2.75 (9)   | 1 x 7'-4"                                 | 2 x 4'-2"           | 3 x 3'-3"             | 1 x 7'-4"           | 2 x 4'-2"             | 3 x 3'-3"           |
| 3.05 (10)  | 1 x 7'-4"                                 | 2 x 4'-2"           | 3 x 3'-3"             | 1 x 7'-4"           | 2 x 4'-2"             | 3 x 3'-3"           |
| 3.05 (10)  | 1 x 7'-4"                                 | 2 x 4'-2"           | 3 x 3'-3"             | 1 x 7'-4"           | 2 x 4'-2"             | 3 x 3'-3"           |
| 3.66 (12)  | 1 x 7'-4"                                 | 2 x 4'-2"           | 3 x 3'-3"             | 1 x 7'-4"           | 2 x 4'-2"             | 3 x 3'-3"           |
| 4.27 (14)  | 1 x 7'-4"                                 | 2 x 4'-2"           | 3 x 3'-3"             | 1 x 7'-4"           | 2 x 4'-2"             | 3 x 3'-3"           |
| 4.88 (16)  | 1 x 7'-4"                                 | 2 x 4'-2"           | 3 x 3'-3"             | 1 x 7'-4"           | 2 x 4'-2"             | 3 x 3'-3"           |
| <b>Main Floor Walls of Two Story ICF Structure Supporting Wood Frame Floors and Roof (TYPE D)</b>              |   |                     |                       |                     |                       |                     |
|  | 6" & 8" Thick Wall                        |                     | 10" & 12" Thick Wall  |                     | 6" & 8" Thick Wall    |                     |
|  | Number and length of shear walls provided |                     |                       |                     |                       |                     |
| 2.44 (8)   | 1 x 8'-3"                                 | 2 x 5'-1"           | 3 x 4'-2"             | 1 x 8'-3"           | 2 x 5'-1"             | 3 x 4'-2"           |
| 2.75 (9)   | 1 x 8'-3"                                 | 2 x 5'-1"           | 3 x 4'-2"             | 1 x 8'-3"           | 2 x 5'-1"             | 3 x 4'-2"           |
| 3.05 (10)  | 1 x 8'-3"                                 | 2 x 5'-1"           | 3 x 4'-2"             | 1 x 8'-3"           | 2 x 5'-1"             | 3 x 4'-2"           |
| 3.05 (10)  | 1 x 8'-3"                                 | 2 x 5'-1"           | 3 x 4'-2"             | 1 x 8'-3"           | 2 x 5'-1"             | 3 x 4'-2"           |
| 3.66 (12)  | 1 x 8'-3"                                 | 2 x 5'-1"           | 3 x 4'-2"             | 1 x 8'-3"           | 2 x 5'-1"             | 3 x 4'-2"           |
| 4.27 (14)  | 1 x 8'-3"                                 | 2 x 5'-1"           | 3 x 4'-2"             | 1 x 8'-3"           | 2 x 5'-1"             | 3 x 4'-2"           |
| 4.88 (16)  | 1 x 8'-3"                                 | 2 x 5'-1"           | 3 x 4'-2"             | 1 x 8'-3"           | 2 x 5'-1"             | 3 x 4'-2"           |
| Vertical Reinforcement   | ICF with 6" Tie Spacing                   | As per table A.1.1. |                       | As per table A.1.1. |                       | As per table A.1.1. |
| Vertical Reinforcement   | ICF with 8" Tie Spacing                   | As per table A.1.2. |                       | As per table A.1.2. |                       | As per table A.1.2. |
| Horizontal Reinforcement   | Block Height of 12" and 18"               | 10 M @              | 450 (18)              | 10 M @              | 450 (18)              | 10 M @ 450 (18)     |
| Horizontal Reinforcement   | Block Height of 16"                       | 10 M @              | 400 (16)              | 10 M @              | 400 (16)              | 10 M @ 400 (16)     |

**NOTES:**

1.  $S_{a,ICF}$  is equivalent spectral response acceleration for ICF walls as provided in Appendix A.
2. This table is to be used in conjunction with the "Design Limitations."
3. Provide two layers of the indicated horizontal and vertical distributed steel specified for 300mm (12") walls. Place each layer as shown in the rebar placement drawing.
4. All four sides of the building are to have a minimum number and length of shear walls that conforms to this table.
5. Use Table A.6 for buildings that do not meet the required wall length of this table.
6. Provide 2-15M concentrated reinforcement at each end of shear walls as shown in shear wall detail.
7. All concentrated reinforcement is to be continues to the bottom of the foundation wall. Provide lap splices as required.
8. Concentrated reinforcement is to be placed in accordance with Bar Placement Detail.

INSULATING CONCRETE FORMS MANUFACTURERS ASSOCIATION



**Table A.5.2400. Above Grade Shear Wall Length for Seismic Zone Classification,  $S_{a,ICF} \leq 0.16$  and Hourly Wind Pressure,  $0.5kPa < q_{1/50} \leq 0.75kPa$  (in a Building Without Walkout Basement), where Building Area  $\leq 2400ft^2$**

| Wall Height m (ft)   | Seismic Zone Classification               |                     |                       |                     |                       |                     |
|--|---|---------------------|-----------------------|---------------------|-----------------------|---------------------|
|  | $S_{a,ICF} \leq 0.07$                     |                     | $S_{a,ICF} \leq 0.11$ |                     | $S_{a,ICF} \leq 0.16$ |                     |
| <b>Second Floor Walls of Two Story ICF Structure Supporting Wood Frame Roof (TYPE A)</b>                       |   |                     |                       |                     |                       |                     |
|  | 6" & 8" Thick Wall                        |                     | 10" & 12" Thick Wall  |                     | 6" & 8" Thick Wall    |                     |
|  | Number and length of shear walls provided |                     |                       |                     |                       |                     |
| 2.44 (8)   | 1 x 7'-4"                                 | 2 x 3'-8"           | 3 x 2'-8"             | 1 x 7'-4"           | 2 x 3'-8"             | 3 x 2'-9"           |
| 2.75 (9)   | 1 x 7'-4"                                 | 2 x 3'-8"           | 3 x 2'-8"             | 1 x 7'-4"           | 2 x 3'-8"             | 3 x 2'-9"           |
| 3.05 (10)  | 1 x 7'-4"                                 | 2 x 3'-8"           | 3 x 2'-8"             | 1 x 7'-4"           | 2 x 4'-2"             | 3 x 3'-3"           |
| 3.66 (12)  | 1 x 7'-4"                                 | 2 x 3'-8"           | 3 x 2'-8"             | 1 x 7'-4"           | 2 x 4'-2"             | 3 x 3'-3"           |
| 4.27 (14)  | 1 x 7'-4"                                 | 2 x 3'-8"           | 3 x 2'-9"             | 1 x 7'-4"           | 2 x 4'-2"             | 3 x 3'-3"           |
| 4.88 (16)  | 1 x 7'-4"                                 | 2 x 3'-8"           | 3 x 2'-9"             | 1 x 7'-4"           | 2 x 4'-2"             | 3 x 3'-3"           |
| <b>Main Floor Walls of One Story ICF Structure Supporting Wood Frame Roof (TYPE B)</b>                         |   |                     |                       |                     |                       |                     |
|  | 6" & 8" Thick Wall                        |                     | 10" & 12" Thick Wall  |                     | 6" & 8" Thick Wall    |                     |
|  | Number and length of shear walls provided |                     |                       |                     |                       |                     |
| 2.44 (8)   | 1 x 7'-4"                                 | 2 x 3'-8"           | 3 x 2'-8"             | 1 x 7'-4"           | 2 x 3'-8"             | 3 x 2'-9"           |
| 2.75 (9)   | 1 x 7'-4"                                 | 2 x 3'-8"           | 3 x 2'-8"             | 1 x 7'-4"           | 2 x 3'-8"             | 3 x 2'-9"           |
| 3.05 (10)  | 1 x 7'-4"                                 | 2 x 3'-8"           | 3 x 2'-8"             | 1 x 7'-4"           | 2 x 3'-8"             | 3 x 2'-9"           |
| 3.66 (12)  | 1 x 7'-4"                                 | 2 x 3'-8"           | 3 x 2'-9"             | 1 x 7'-4"           | 2 x 4'-2"             | 3 x 3'-3"           |
| 4.27 (14)  | 1 x 7'-4"                                 | 2 x 3'-8"           | 3 x 2'-9"             | 1 x 7'-4"           | 2 x 4'-2"             | 3 x 3'-3"           |
| 4.88 (16)  | 1 x 7'-4"                                 | 2 x 3'-8"           | 3 x 2'-9"             | 1 x 7'-4"           | 2 x 4'-2"             | 3 x 3'-3"           |
| <b>Main Floor Walls of Two Story Structure Supporting 2nd Story Wood Framed Walls, Floor and Roof (TYPE C)</b> |   |                     |                       |                     |                       |                     |
|  | 6" & 8" Thick Wall                        |                     | 10" & 12" Thick Wall  |                     | 6" & 8" Thick Wall    |                     |
|  | Number and length of shear walls provided |                     |                       |                     |                       |                     |
| 2.44 (8)   | 1 x 7'-4"                                 | 2 x 4'-4"           | 3 x 3'-3"             | 1 x 7'-4"           | 2 x 3'-8"             | 3 x 2'-9"           |
| 2.75 (9)   | 1 x 7'-4"                                 | 2 x 4'-4"           | 3 x 3'-3"             | 1 x 7'-4"           | 2 x 4'-7"             | 3 x 3'-8"           |
| 3.05 (10)  | 1 x 7'-4"                                 | 2 x 4'-8"           | 3 x 3'-8"             | 1 x 7'-4"           | 2 x 4'-7"             | 3 x 3'-8"           |
| 3.66 (12)  | 1 x 7'-10"                                | 2 x 5'-1"           | 3 x 3'-8"             | 1 x 7'-10"          | 2 x 5'-1"             | 3 x 3'-9"           |
| 4.27 (14)  | 1 x 7'-10"                                | 2 x 5'-1"           | 3 x 4'-2"             | 1 x 7'-10"          | 2 x 5'-6"             | 3 x 4'-2"           |
| 4.88 (16)  | 1 x 7'-10"                                | 2 x 5'-1"           | 3 x 4'-2"             | 1 x 7'-10"          | 2 x 5'-6"             | 3 x 4'-2"           |
| <b>Main Floor Walls of Two Story ICF Structure Supporting Wood Frame Floors and Roof (TYPE D)</b>              |   |                     |                       |                     |                       |                     |
|  | 6" & 8" Thick Wall                        |                     | 10" & 12" Thick Wall  |                     | 6" & 8" Thick Wall    |                     |
|  | Number and length of shear walls provided |                     |                       |                     |                       |                     |
| 2.44 (8)   | 1 x 8'-3"                                 | 2 x 5'-1"           | 3 x 4'-2"             | 1 x 8'-3"           | 2 x 5'-1"             | 3 x 4'-2"           |
| 2.75 (9)   | 1 x 8'-3"                                 | 2 x 5'-6"           | 3 x 4'-2"             | 1 x 8'-3"           | 2 x 5'-12"            | 3 x 4'-7"           |
| 3.05 (10)  | 1 x 8'-9"                                 | 2 x 5'-12"          | 3 x 4'-7"             | 1 x 8'-9"           | 2 x 5'-12"            | 3 x 4'-7"           |
| 3.66 (12)  | 1 x 9'-2"                                 | 2 x 6'-5"           | 3 x 4'-7"             | 1 x 9'-2"           | 2 x 6'-9"             | 3 x 5'-6"           |
| 4.27 (14)  | 1 x 9'-2"                                 | 2 x 6'-5"           | 3 x 4'-7"             | 1 x 9'-8"           | 2 x 7'-8"             | 3 x 5'-12"          |
| 4.88 (16)  | 1 x 9'-2"                                 | 2 x 6'-5"           | 3 x 5'-1"             | 1 x 10'-1"          | 2 x 7'-10"            | 3 x 6'-5"           |
| Vertical Reinforcement   | ICF with 6" Tie Spacing                   | As per table A.1.1. |                       | As per table A.1.1. |                       | As per table A.1.1. |
| Horizontal Reinforcement   | ICF with 8" Tie Spacing                   | As per table A.1.2. |                       | As per table A.1.2. |                       | As per table A.1.2. |
|  | Block Height of 12" and 18"               | 10 M @ 450 (18)     |                       | 10 M @ 450 (18)     |                       | 10 M @ 450 (18)     |
|  | Block Height of 16"                       | 10 M @ 400 (16)     |                       | 10 M @ 400 (16)     |                       | 10 M @ 400 (16)     |

**NOTES:**

1.  $S_{a,ICF}$  is equivalent spectral response acceleration for ICF walls as provided in Appendix A.
2. This table is to be used in conjunction with the "Design Limitations."
3. Provide two layers of the indicated horizontal and vertical distributed steel specified for 300mm (12") walls. Place each layer as shown in the rebar placement drawing.
4. All four sides of the building are to have a minimum number and length of shear walls that conforms to this table.
5. Use Table A.6 for buildings that do not meet the required wall length of this table.
6. Provide 2-15M concentrated reinforcement at each end of shear walls as shown in shear wall detail.
7. All concentrated reinforcement is to be continues to the bottom of the foundation wall. Provide lap splices as required.
8. Concentrated reinforcement is to be placed in accordance with Bar Placement Detail.

**INSULATING CONCRETE FORMS MANUFACTURERS ASSOCIATION**



**Table A.6.2400. Above Grade Shear Wall Length for Seismic Zone Classification,  $S_{a,ICF} > 0.16$  and Hourly Wind Pressure,  $q_{1/50} \leq 1.05\text{kPa}$  (in a Building Without Walkout Basement), where Building Area  $\leq 2400\text{ft}^2$**

| Wall Height m (ft)   | Seismic Zone Classification               |                             |                             |                             |                             |                              |                              |                              |
|--|---|-----------------------------|-----------------------------|-----------------------------|-----------------------------|------------------------------|------------------------------|------------------------------|
|  | $S_{a,ICF} \leq 0.16$                     |                             | $S_{a,ICF} \leq 0.31$       |                             | $S_{a,ICF} \leq 0.53$       |                              | $S_{a,ICF} \leq 0.79$        |                              |
| <b>Second Floor Walls of Two Story ICF Structure Supporting Wood Frame Roof (TYPE A)</b>                       |   |                             |                             |                             |                             |                              |                              |                              |
|  | 6" & 8" Thick Wall                        | 10" & 12" Thick Wall        | 6" & 8" Thick Wall          | 10" & 12" Thick Wall        | 6" & 8" Thick Wall          | 10" & 12" Thick Wall         | 6" & 8" Thick Wall           | 10" & 12" Thick Wall         |
|  | Number and length of shear walls provided |                             |                             |                             |                             |                              |                              |                              |
| 2.44 (8)   | 1x7'-4" 2x3'-8" 3x2'-9"                   | 1x7'-4" 2x3'-8" 3x2'-9"     | 1x7'-4" 2x4'-7" 3x4'-0"     | 1x7'-4" 2x4'-7" 3x4'-0"     | 1x9'-2" 2x6'-5" 3x5'-6"     | 1x9'-2" 2x6'-5" 3x5'-6"      | 1x10'-1" 2x7'-4" 3x5'-6"     | 1x11'-0" 2x7'-4" 3x6'-5"     |
| 2.75 (9)   | 1x7'-4" 2x3'-8" 3x2'-9"                   | 1x7'-4" 2x3'-8" 3x2'-9"     | 1x8'-3" 2x5'-6" 3x4'-0"     | 1x8'-3" 2x5'-6" 3x4'-0"     | 1x10'-1" 2x6'-5" 3x5'-6"    | 1x10'-1" 2x6'-5" 3x5'-6"     | 1x11'-0" 2x7'-4" 3x6'-5"     | 1x11'-0" 2x8'-3" 3x6'-5"     |
| 3.05 (10)  | 1x7'-4" 2x4'-7" 3x3'-8"                   | 1x7'-4" 2x4'-7" 3x3'-8"     | 1x9'-2" 2x5'-12" 3x5'-0"    | 1x9'-2" 2x5'-12" 3x5'-0"    | 1x11'-0" 2x7'-4" 3x6'-5"    | 1x11'-0" 2x7'-4" 3x6'-5"     | 1x12'-11" 2x9'-2" 3x7'-4"    | 1x12'-11" 2x9'-2" 3x7'-4"    |
| <b>Main Floor Walls of One Story ICF Structure Supporting Wood Frame Roof (TYPE B)</b>                         |   |                             |                             |                             |                             |                              |                              |                              |
|  | 6" & 8" Thick Wall                        | 10" & 12" Thick Wall        | 6" & 8" Thick Wall          | 10" & 12" Thick Wall        | 6" & 8" Thick Wall          | 10" & 12" Thick Wall         | 6" & 8" Thick Wall           | 10" & 12" Thick Wall         |
|  | Number and length of shear walls provided |                             |                             |                             |                             |                              |                              |                              |
| 2.44 (8)   | 1x7'-4" 2x3'-8" 3x2'-9"                   | 1x7'-4" 2x3'-8" 3x2'-9"     | 1x7'-4" 2x4'-7" 3x4'-0"     | 1x7'-4" 2x4'-7" 3x4'-0"     | 1x8'-3" 2x5'-6" 3x4'-2"     | 1x8'-3" 2x5'-6" 3x4'-2"      | 1x9'-2" 2x6'-5" 3x5'-1"      | 1x9'-2" 2x6'-5" 3x5'-1"      |
| 2.75 (9)   | 1x7'-4" 2x3'-8" 3x2'-9"                   | 1x7'-4" 2x3'-8" 3x2'-9"     | 1x7'-4" 2x4'-7" 3x4'-0"     | 1x7'-4" 2x4'-7" 3x4'-0"     | 1x9'-2" 2x6'-5" 3x4'-7"     | 1x9'-2" 2x6'-5" 3x4'-7"      | 1x10'-1" 2x7'-4" 3x5'-6"     | 1x10'-1" 2x7'-4" 3x5'-6"     |
| 3.05 (10)  | 1x7'-4" 2x3'-8" 3x2'-9"                   | 1x7'-4" 2x3'-8" 3x2'-9"     | 1x7'-4" 2x5'-6" 3x5'-0"     | 1x7'-4" 2x5'-6" 3x5'-0"     | 1x10'-1" 2x6'-5" 3x6'-5"    | 1x10'-1" 2x6'-5" 3x6'-5"     | 1x11'-0" 2x7'-4" 3x6'-5"     | 1x11'-0" 2x8'-3" 3x6'-5"     |
| 3.66 (12)  | 1x7'-4" 2x4'-7" 3x3'-8"                   | 1x7'-4" 2x4'-7" 3x3'-8"     | 1x8'-3" 2x6'-0" --          | 1x8'-3" 2x6'-0" --          | 1x11'-0" 2x6'-11" 3x6'-0"   | 1x11'-0" 2x6'-11" 3x6'-0"    | 1x12'-11" 2x9'-2" 3x7'-4"    | 1x13'-0" 2x9'-2" 3x7'-4"     |
| 4.27 (14)  | 1x7'-4" 2x4'-7" 3x3'-8"                   | 1x7'-4" 2x5'-1" 3x3'-8"     | 1x10'-1" 2x7'-0" --         | 1x10'-1" 2x7'-0" --         | 1x12'-11" 2x9'-2" 3x7'-4"   | 1x13'-0" 2x9'-2" 3x7'-4"     | 1x14'-9" 2x10'-1" 3x8'-3"    | 1x15'-8" 2x10'-1" 3x8'-3"    |
| 4.88 (16)  | 1x7'-4" 2x5'-1" 3x3'-8"                   | 1x8'-3" 2x5'-6" 3x4'-7"     | 1x10'-1" 2x8'-0" --         | 1x11'-0" 2x8'-0" --         | 1x13'-10" 2x10'-1" 3x8'-0"  | 1x15'-8" 2x10'-1" 3x8'-0"    | 1x16'-7" 2x11'-2" 3x9'-2"    | 1x16'-7" 2x11'-2" 3x9'-2"    |
| <b>Main Floor Walls of Two Story Structure Supporting 2nd Story Wood Framed Walls, Floor and Roof (TYPE C)</b> |   |                             |                             |                             |                             |                              |                              |                              |
|  | 6" & 8" Thick Wall                        | 10" & 12" Thick Wall        | 6" & 8" Thick Wall          | 10" & 12" Thick Wall        | 6" & 8" Thick Wall          | 10" & 12" Thick Wall         | 6" & 8" Thick Wall           | 10" & 12" Thick Wall         |
|  | Number and length of shear walls provided |                             |                             |                             |                             |                              |                              |                              |
| 2.44 (8)   | 1x8'-3" 2x5'-6" 3x4'-7"                   | 1x8'-3" 2x5'-6" 3x4'-7"     | 1x11'-0" 2x8'-3" 3x5'-12"   | 1x11'-0" 2x8'-3" 3x5'-12"   | 1x15'-8" 2x10'-1" 3x8'-3"   | 1x15'-8" 2x10'-1" 3x8'-3"    | 1x15'-8" 2x11'-0" 3x8'-9"    | 1x15'-8" 2x11'-0" 3x8'-9"    |
| 2.75 (9)   | 1x8'-3" 2x5'-6" 3x4'-7"                   | 1x8'-3" 2x5'-6" 3x4'-7"     | 1x12'-11" 2x9'-2" 3x6'-5"   | 1x12'-11" 2x9'-2" 3x6'-5"   | 1x15'-8" 2x10'-1" 3x8'-3"   | 1x15'-8" 2x10'-1" 3x8'-3"    | 1x16'-7" 2x11'-2" 3x9'-2"    | 1x16'-7" 2x11'-2" 3x9'-2"    |
| 3.05 (10)  | 1x8'-3" 2x5'-6" 3x4'-7"                   | 1x8'-3" 2x5'-6" 3x4'-7"     | 1x13'-10" 2x9'-2" 3x7'-4"   | 1x13'-10" 2x9'-2" 3x7'-4"   | 1x15'-8" 2x11'-0" 3x9'-2"   | 1x15'-8" 2x11'-0" 3x9'-2"    | 1x17'-6" 2x11'-2" 3x10'-1"   | 1x17'-6" 2x11'-2" 3x10'-1"   |
| 3.66 (12)  | 1x9'-2" 2x5'-12" 3x5'-0"                  | 1x10'-1" 2x6'-11" 3x5'-6"   | 1x13'-10" 2x9'-2" 3x8'-3"   | 1x14'-9" 2x10'-1" 3x8'-3"   | 1x17'-6" 2x11'-2" 3x10'-1"  | 1x17'-6" 2x11'-2" 3x10'-1"   | 1x19'-4" 2x12'-11" 3x11'-0"  | 1x19'-4" 2x12'-11" 3x11'-0"  |
| 4.27 (14)  | 1x10'-1" 2x6'-11" 3x5'-6"                 | 1x10'-1" 2x6'-11" 3x5'-6"   | 1x14'-9" 2x10'-1" 3x9'-2"   | 1x14'-9" 2x10'-1" 3x9'-2"   | 1x18'-5" 2x12'-11" 3x11'-0" | 1x18'-5" 2x12'-11" 3x11'-0"  | 1x20'-3" 2x14'-9" 3x11'-12"  | 1x20'-3" 2x14'-9" 3x11'-12"  |
| 4.88 (16)  | 1x10'-1" 2x6'-11" 3x5'-6"                 | 1x10'-1" 2x6'-11" 3x5'-6"   | 1x14'-9" 2x11'-0" 3x9'-2"   | 1x14'-9" 2x11'-0" 3x9'-2"   | 1x19'-4" 2x12'-11" 3x11'-0" | 1x20'-3" 2x13'-10" 3x11'-12" | 1x22'-1" 2x15'-8" 3x12'-5"   | 1x22'-1" 2x15'-8" 3x12'-5"   |
| <b>Main Floor Walls of Two Story ICF Structure Supporting Wood Frame Floors and Roof (TYPE D)</b>              |   |                             |                             |                             |                             |                              |                              |                              |
|  | 6" & 8" Thick Wall                        | 10" & 12" Thick Wall        | 6" & 8" Thick Wall          | 10" & 12" Thick Wall        | 6" & 8" Thick Wall          | 10" & 12" Thick Wall         | 6" & 8" Thick Wall           | 10" & 12" Thick Wall         |
|  | Number and length of shear walls provided |                             |                             |                             |                             |                              |                              |                              |
| 2.44 (8)   | 1x10'-1" 2x6'-11" 3x5'-6"                 | 1x11'-0" 2x6'-11" 3x5'-6"   | 1x14'-9" 2x10'-1" 3x7'-10"  | 1x15'-8" 2x10'-1" 3x8'-3"   | 1x17'-6" 2x12'-5" 3x10'-1"  | 1x18'-5" 2x12'-11" 3x11'-0"  | 1x19'-4" 2x13'-10" 3x11'-0"  | 1x20'-4" 2x14'-9" 3x11'-12"  |
| 2.75 (9)   | 1x11'-0" 2x7'-4" 3x5'-6"                  | 1x11'-0" 2x7'-4" 3x5'-12"   | 1x15'-8" 2x11'-0" 3x8'-3"   | 1x15'-8" 2x11'-0" 3x8'-3"   | 1x18'-5" 2x12'-11" 3x11'-0" | 1x19'-4" 2x13'-10" 3x11'-0"  | 1x20'-3" 2x14'-9" 3x11'-6"   | 1x21'-2" 2x15'-8" 3x11'-12"  |
| 3.05 (10)  | 1x11'-0" 2x7'-4" 3x5'-12"                 | 1x11'-12" 2x7'-10" 3x5'-12" | 1x16'-7" 2x11'-0" 3x8'-3"   | 1x16'-7" 2x11'-0" 3x8'-3"   | 1x19'-4" 2x13'-10" 3x11'-0" | 1x20'-3" 2x13'-10" 3x11'-0"  | 1x22'-1" 2x15'-8" 3x11'-12"  | 1x22'-1" 2x16'-7" 3x12'-11"  |
| 3.66 (12)  | 1x11'-0" 2x7'-10" 3x6'-5"                 | 1x12'-11" 2x9'-2" 3x6'-11"  | 1x17'-6" 2x11'-0" 3x9'-2"   | 1x18'-5" 2x12'-5" 3x10'-1"  | 1x21'-2" 2x14'-9" 3x11'-12" | 1x21'-2" 2x14'-9" 3x11'-12"  | 1x23'-0" 2x16'-6" 3x12'-11"  | 1x23'-11" 2x17'-6" 3x13'-10" |
| 4.27 (14)  | 1x11'-12" 2x8'-3" 3x6'-5"                 | 1x12'-3" 2x9'-2" 3x6'-11"   | 1x17'-6" 2x11'-12" 3x10'-1" | 1x18'-5" 2x12'-5" 3x10'-1"  | 1x22'-1" 2x15'-8" 3x12'-11" | 1x23'-0" 2x15'-9" 3x12'-11"  | 1x24'-10" 2x18'-5" 3x13'-10" | 1x25'-9" 2x19'-4" 3x14'-9"   |
| 4.88 (16)  | 1x11'-12" 2x8'-3" 3x6'-5"                 | 1x12'-11" 2x9'-2" 3x7'-4"   | 1x17'-6" 2x11'-12" 3x10'-1" | 1x18'-5" 2x12'-11" 3x10'-1" | 1x22'-1" 2x15'-8" 3x12'-11" | 1x24'-5" 2x17'-6" 3x13'-10"  | 1x26'-0" 2x20'-3" 3x14'-9"   | 1x27'-0" 2x20'-3" 3x15'-8"   |
| Vertical Reinforcement   | ICF with 6" The Spacing                   | As per table A.2.1.         | As per table A.2.1.         | As per table A.2.1.         | As per table A.2.1.         | As per table A.2.1.          | As per table A.2.1.          | As per table A.2.1.          |
| Horizontal Reinforcement   | ICF with 8" The Spacing                   | As per table A.2.2.         | As per table A.2.2.         | As per table A.2.2.         | As per table A.2.2.         | As per table A.2.2.          | As per table A.2.2.          | As per table A.2.2.          |
|  | Block Height of 12" and 18"               | As per table A.2.1.         | As per table A.2.1.         | As per table A.2.1.         | As per table A.2.1.         | As per table A.2.1.          | As per table A.2.1.          | As per table A.2.1.          |
|  | Block Height of 16"                       | As per table A.2.2.         | As per table A.2.2.         | As per table A.2.2.         | As per table A.2.2.         | As per table A.2.2.          | As per table A.2.2.          | As per table A.2.2.          |

**NOTES:**

1.  $S_{a,ICF}$  is equivalent spectral response acceleration for ICF walls as provided in Appendix A.
2. This table is to be used in conjunction with the "Design Limitations."
3. Provide two layers of the indicated horizontal and vertical distributed steel specified for 300mm (12") walls. Place each layer as shown in the rebar placement drawing.
4. All four sides of the building are to have a minimum number and length of shear walls that conforms to this table.
5. Provide 2-15M concentrated reinforcement at each end of shear walls as shown in shear wall detail.
6. All concentrated reinforcement is to be continues to the bottom of the foundation wall. Provide lap splices as required.
7. Concentrated reinforcement is to be placed in accordance with Bar Placement Detail.
8. Horizontal reinforcement in shear walls where  $S_{a,ICF} > 0.16$  must be anchored using a standard 180° hook around vertical end bars.
9. When using this table for  $S_{a,ICF} \leq 0.16$ , use the vertical and horizontal distributed steel in Tables A.2.1. or A.2.2.

INSULATING CONCRETE FORMS MANUFACTURERS ASSOCIATION



**Table A.7.2400. Above Grade Shear Wall Length for Seismic Zone Classification,  $S_{a,ICF} \leq 0.16$  and Hourly Wind Pressure,  $q_{1/50} \leq 0.5kPa$  (in a Building With Walk Basement), where Building Area  $\leq 2400ft^2$**

| Wall Height m (ft)   | Seismic Zone Classification               |                     |                       |                 |                       |                     |                      |                 |            |                     |            |                 |             |            |            |             |            |             |
|--|---|---------------------|-----------------------|-----------------|-----------------------|---------------------|----------------------|-----------------|------------|---------------------|------------|-----------------|-------------|------------|------------|-------------|------------|-------------|
|  | $S_{a,ICF} \leq 0.07$                     |                     | $S_{a,ICF} \leq 0.11$ |                 | $S_{a,ICF} \leq 0.16$ |                     |                      |                 |            |                     |            |                 |             |            |            |             |            |             |
| <b>Second Floor Walls of Two Story ICF Structure Supporting Wood Frame Roof (TYPE E)</b>                       |   |                     |                       |                 |                       |                     |                      |                 |            |                     |            |                 |             |            |            |             |            |             |
|  | 6" & 8" Thick Wall                        |                     | 10" & 12" Thick Wall  |                 | 6" & 8" Thick Wall    |                     | 10" & 12" Thick Wall |                 |            |                     |            |                 |             |            |            |             |            |             |
|  | Number and length of shear walls provided |                     |                       |                 |                       |                     |                      |                 |            |                     |            |                 |             |            |            |             |            |             |
| 2.44 (8)   | 1 x 7'-4"                                 | 2 x 3'-8"           | 3 x 2'-8"             | 1 x 7'-4"       | 2 x 3'-8"             | 3 x 2'-8"           | 1 x 7'-4"            | 2 x 3'-8"       | 3 x 2'-9"  | 1 x 7'-4"           | 2 x 3'-8"  | 3 x 2'-9"       | 1 x 7'-4"   | 2 x 4'-2"  | 3 x 3'-8"  | 1 x 7'-4"   | 2 x 4'-7"  | 3 x 3'-8"   |
| 2.75 (9)   | 1 x 7'-4"                                 | 2 x 3'-8"           | 3 x 2'-8"             | 1 x 7'-4"       | 2 x 3'-8"             | 3 x 2'-8"           | 1 x 7'-4"            | 2 x 3'-8"       | 3 x 2'-9"  | 1 x 7'-4"           | 2 x 3'-8"  | 3 x 2'-9"       | 1 x 7'-4"   | 2 x 3'-12" | 3 x 3'-11" | 1 x 7'-4"   | 2 x 4'-7"  | 3 x 3'-12"  |
| 3.05 (10)  | 1 x 7'-4"                                 | 2 x 3'-8"           | 3 x 2'-8"             | 1 x 7'-4"       | 2 x 3'-8"             | 3 x 2'-8"           | 1 x 7'-4"            | 2 x 4'-2"       | 3 x 3'-3"  | 1 x 7'-4"           | 2 x 4'-2"  | 3 x 3'-3"       | 1 x 7'-10"  | 2 x 5'-1"  | 3 x 3'-12" | 1 x 8'-7"   | 2 x 5'-3"  | 3 x 3'-12"  |
| 3.66 (12)  | 1 x 7'-4"                                 | 2 x 3'-8"           | 3 x 2'-9"             | 1 x 7'-4"       | 2 x 3'-8"             | 3 x 2'-9"           | 1 x 7'-10"           | 2 x 5'-1"       | 3 x 3'-12" | 1 x 7'-10"          | 2 x 5'-1"  | 3 x 3'-12"      | 1 x 9'-8"   | 2 x 6'-5"  | 3 x 5'-11" | 1 x 10'-1"  | 2 x 6'-5"  | 3 x 5'-11"  |
| 4.27 (14)  | 1 x 7'-4"                                 | 2 x 4'-2"           | 3 x 3'-8"             | 1 x 7'-4"       | 2 x 4'-7"             | 3 x 3'-8"           | 1 x 9'-2"            | 2 x 5'-6"       | 3 x 4'-4"  | 1 x 9'-8"           | 2 x 6'-5"  | 3 x 4'-11"      | 1 x 10'-7"  | 2 x 6'-11" | 3 x 5'-12" | 1 x 11'-6"  | 2 x 7'-8"  | 3 x 5'-12"  |
| 4.88 (16)  | 1 x 7'-4"                                 | 2 x 4'-7"           | 3 x 3'-8"             | 1 x 8'-3"       | 2 x 5'-1"             | 3 x 4'-2"           | 1 x 9'-2"            | 2 x 5'-12"      | 3 x 4'-7"  | 1 x 10'-1"          | 2 x 6'-11" | 3 x 5'-3"       | 1 x 11'-0"  | 2 x 7'-4"  | 3 x 5'-12" | 1 x 12'-11" | 2 x 8'-7"  | 3 x 6'-9"   |
| <b>Main Floor Walls of One Story ICF Structure Supporting Wood Frame Roof (TYPE F)</b>                         |   |                     |                       |                 |                       |                     |                      |                 |            |                     |            |                 |             |            |            |             |            |             |
|  | 6" & 8" Thick Wall                        |                     | 10" & 12" Thick Wall  |                 | 6" & 8" Thick Wall    |                     | 10" & 12" Thick Wall |                 |            |                     |            |                 |             |            |            |             |            |             |
|  | Number and length of shear walls provided |                     |                       |                 |                       |                     |                      |                 |            |                     |            |                 |             |            |            |             |            |             |
| 2.44 (8)   | 1 x 7'-4"                                 | 2 x 3'-8"           | 3 x 2'-8"             | 1 x 7'-4"       | 2 x 3'-8"             | 3 x 2'-8"           | 1 x 7'-4"            | 2 x 3'-8"       | 3 x 2'-9"  | 1 x 7'-4"           | 2 x 3'-8"  | 3 x 2'-9"       | 1 x 7'-4"   | 2 x 3'-8"  | 3 x 2'-9"  | 1 x 7'-4"   | 2 x 4'-2"  | 3 x 3'-11"  |
| 2.75 (9)   | 1 x 7'-4"                                 | 2 x 3'-8"           | 3 x 2'-8"             | 1 x 7'-4"       | 2 x 3'-8"             | 3 x 2'-8"           | 1 x 7'-4"            | 2 x 3'-8"       | 3 x 2'-9"  | 1 x 7'-4"           | 2 x 3'-8"  | 3 x 2'-9"       | 1 x 7'-4"   | 2 x 4'-2"  | 3 x 3'-3"  | 1 x 7'-10"  | 2 x 4'-7"  | 3 x 3'-4"   |
| 3.05 (10)  | 1 x 7'-4"                                 | 2 x 3'-8"           | 3 x 2'-8"             | 1 x 7'-4"       | 2 x 3'-8"             | 3 x 2'-8"           | 1 x 7'-4"            | 2 x 4'-2"       | 3 x 3'-3"  | 1 x 7'-4"           | 2 x 4'-2"  | 3 x 3'-3"       | 1 x 7'-10"  | 2 x 5'-1"  | 3 x 3'-12" | 1 x 8'-9"   | 2 x 5'-3"  | 3 x 3'-12"  |
| 3.66 (12)  | 1 x 7'-4"                                 | 2 x 3'-8"           | 3 x 2'-9"             | 1 x 7'-4"       | 2 x 3'-8"             | 3 x 2'-9"           | 1 x 7'-10"           | 2 x 5'-1"       | 3 x 3'-12" | 1 x 7'-10"          | 2 x 5'-1"  | 3 x 3'-12"      | 1 x 9'-8"   | 2 x 6'-5"  | 3 x 5'-11" | 1 x 10'-1"  | 2 x 6'-5"  | 3 x 5'-11"  |
| 4.27 (14)  | 1 x 7'-4"                                 | 2 x 4'-2"           | 3 x 3'-8"             | 1 x 7'-4"       | 2 x 4'-7"             | 3 x 3'-8"           | 1 x 9'-2"            | 2 x 5'-6"       | 3 x 4'-4"  | 1 x 9'-8"           | 2 x 6'-5"  | 3 x 4'-11"      | 1 x 10'-7"  | 2 x 6'-11" | 3 x 5'-12" | 1 x 11'-6"  | 2 x 7'-8"  | 3 x 5'-12"  |
| 4.88 (16)  | 1 x 7'-4"                                 | 2 x 4'-7"           | 3 x 3'-8"             | 1 x 8'-3"       | 2 x 5'-1"             | 3 x 4'-2"           | 1 x 9'-2"            | 2 x 5'-12"      | 3 x 4'-7"  | 1 x 10'-1"          | 2 x 6'-11" | 3 x 5'-3"       | 1 x 11'-0"  | 2 x 7'-4"  | 3 x 5'-12" | 1 x 12'-11" | 2 x 8'-7"  | 3 x 6'-9"   |
| <b>Main Floor Walls of Two Story Structure Supporting 2nd Story Wood Framed Walls, Floor and Roof (TYPE G)</b> |   |                     |                       |                 |                       |                     |                      |                 |            |                     |            |                 |             |            |            |             |            |             |
|  | 6" & 8" Thick Wall                        |                     | 10" & 12" Thick Wall  |                 | 6" & 8" Thick Wall    |                     | 10" & 12" Thick Wall |                 |            |                     |            |                 |             |            |            |             |            |             |
|  | Number and length of shear walls provided |                     |                       |                 |                       |                     |                      |                 |            |                     |            |                 |             |            |            |             |            |             |
| 2.44 (8)   | 1 x 7'-4"                                 | 2 x 4'-7"           | 3 x 3'-8"             | 1 x 7'-4"       | 2 x 4'-7"             | 3 x 3'-8"           | 1 x 9'-2"            | 2 x 5'-6"       | 3 x 4'-7"  | 1 x 9'-2"           | 2 x 5'-12" | 3 x 4'-7"       | 1 x 11'-6"  | 2 x 7'-4"  | 3 x 5'-6"  | 1 x 11'-12" | 2 x 7'-4"  | 3 x 5'-12"  |
| 2.75 (9)   | 1 x 7'-4"                                 | 2 x 4'-7"           | 3 x 3'-8"             | 1 x 7'-4"       | 2 x 4'-7"             | 3 x 3'-8"           | 1 x 9'-8"            | 2 x 5'-12"      | 3 x 4'-7"  | 1 x 10'-1"          | 2 x 6'-5"  | 3 x 4'-7"       | 1 x 12'-5"  | 2 x 7'-10" | 3 x 5'-12" | 1 x 12'-7"  | 2 x 8'-3"  | 3 x 6'-5"   |
| 3.05 (10)  | 1 x 7'-10"                                | 2 x 5'-1"           | 3 x 3'-12"            | 1 x 7'-10"      | 2 x 5'-1"             | 3 x 3'-12"          | 1 x 10'-7"           | 2 x 6'-9"       | 3 x 5'-6"  | 1 x 10'-7"          | 2 x 6'-9"  | 3 x 5'-6"       | 1 x 12'-11" | 2 x 8'-7"  | 3 x 6'-9"  | 1 x 13'-4"  | 2 x 8'-7"  | 3 x 6'-9"   |
| 3.66 (12)  | 1 x 8'-7"                                 | 2 x 5'-10"          | 3 x 4'-7"             | 1 x 8'-7"       | 2 x 5'-10"            | 3 x 4'-7"           | 1 x 11'-4"           | 2 x 7'-8"       | 3 x 5'-12" | 1 x 11'-4"          | 2 x 7'-8"  | 3 x 5'-12"      | 1 x 13'-10" | 2 x 9'-6"  | 3 x 7'-4"  | 1 x 13'-10" | 2 x 9'-6"  | 3 x 7'-4"   |
| 4.27 (14)  | 1 x 8'-11"                                | 2 x 5'-12"          | 3 x 4'-11"            | 1 x 9'-6"       | 2 x 6'-5"             | 3 x 4'-11"          | 1 x 11'-8"           | 2 x 7'-10"      | 3 x 6'-5"  | 1 x 12'-5"          | 2 x 8'-3"  | 3 x 6'-5"       | 1 x 14'-3"  | 2 x 9'-8"  | 3 x 7'-10" | 1 x 15'-0"  | 2 x 10'-5" | 3 x 8'-3"   |
| 4.88 (16)  | 1 x 9'-2"                                 | 2 x 6'-5"           | 3 x 5'-1"             | 1 x 10'-1"      | 2 x 6'-9"             | 3 x 5'-3"           | 1 x 11'-12"          | 2 x 8'-3"       | 3 x 6'-11" | 1 x 12'-11"         | 2 x 8'-9"  | 3 x 6'-11"      | 1 x 14'-3"  | 2 x 9'-8"  | 3 x 7'-10" | 1 x 15'-8"  | 2 x 10'-7" | 3 x 8'-7"   |
| <b>Main Floor Walls of Two Story ICF Structure Supporting Wood Frame Floors and Roof (TYPE H)</b>              |   |                     |                       |                 |                       |                     |                      |                 |            |                     |            |                 |             |            |            |             |            |             |
|  | 6" & 8" Thick Wall                        |                     | 10" & 12" Thick Wall  |                 | 6" & 8" Thick Wall    |                     | 10" & 12" Thick Wall |                 |            |                     |            |                 |             |            |            |             |            |             |
|  | Number and length of shear walls provided |                     |                       |                 |                       |                     |                      |                 |            |                     |            |                 |             |            |            |             |            |             |
| 2.44 (8)   | 1 x 8'-7"                                 | 2 x 5'-6"           | 3 x 4'-2"             | 1 x 9'-2"       | 2 x 5'-10"            | 3 x 4'-7"           | 1 x 11'-6"           | 2 x 7'-4"       | 3 x 5'-6"  | 1 x 12'-3"          | 2 x 7'-10" | 3 x 5'-12"      | 1 x 14'-9"  | 2 x 9'-2"  | 3 x 7'-4"  | 1 x 15'-2"  | 2 x 10'-1" | 3 x 7'-10"  |
| 2.75 (9)   | 1 x 8'-11"                                | 2 x 5'-12"          | 3 x 4'-4"             | 1 x 10'-1"      | 2 x 5'-12"            | 3 x 4'-7"           | 1 x 11'-12"          | 2 x 7'-8"       | 3 x 5'-12" | 1 x 12'-11"         | 2 x 8'-3"  | 3 x 6'-5"       | 1 x 15'-2"  | 2 x 10'-1" | 3 x 7'-10" | 1 x 16'-1"  | 2 x 10'-7" | 3 x 8'-3"   |
| 3.05 (10)  | 1 x 9'-6"                                 | 2 x 5'-12"          | 3 x 4'-7"             | 1 x 10'-1"      | 2 x 6'-5"             | 3 x 5'-1"           | 1 x 12'-7"           | 2 x 8'-3"       | 3 x 6'-5"  | 1 x 13'-10"         | 2 x 8'-9"  | 3 x 6'-11"      | 1 x 16'-1"  | 2 x 10'-7" | 3 x 8'-3"  | 1 x 17'-0"  | 2 x 11'-0" | 3 x 8'-9"   |
| 3.66 (12)  | 1 x 10'-7"                                | 2 x 6'-11"          | 3 x 5'-6"             | 1 x 10'-7"      | 2 x 6'-11"            | 3 x 5'-6"           | 1 x 13'-4"           | 2 x 9'-2"       | 3 x 7'-11" | 1 x 13'-10"         | 2 x 9'-2"  | 3 x 7'-11"      | 1 x 16'-7"  | 2 x 11'-4" | 3 x 8'-11" | 1 x 17'-6"  | 2 x 11'-4" | 3 x 8'-11"  |
| 4.27 (14)  | 1 x 10'-7"                                | 2 x 7'-4"           | 3 x 5'-12"            | 1 x 11'-6"      | 2 x 7'-10"            | 3 x 6'-5"           | 1 x 13'-10"          | 2 x 9'-2"       | 3 x 7'-4"  | 1 x 15'-2"          | 2 x 10'-1" | 3 x 8'-3"       | 1 x 16'-10" | 2 x 11'-6" | 3 x 9'-2"  | 1 x 19'-4"  | 2 x 12'-5" | 3 x 10'-11" |
| 4.88 (16)  | 1 x 10'-7"                                | 2 x 7'-4"           | 3 x 5'-12"            | 1 x 11'-12"     | 2 x 8'-3"             | 3 x 6'-5"           | 1 x 13'-10"          | 2 x 9'-2"       | 3 x 7'-4"  | 1 x 16'-1"          | 2 x 11'-0" | 3 x 8'-3"       | 1 x 16'-10" | 2 x 11'-6" | 3 x 9'-2"  | 1 x 19'-4"  | 2 x 13'-2" | 3 x 10'-5"  |
| Vertical Reinforcement   | ICF with 6" Tie Spacing                   | As per table A.1.1. |                       |                 |                       | As per table A.1.1. |                      |                 |            | As per table A.1.1. |            |                 |             |            |            |             |            |             |
| Vertical Reinforcement   | ICF with 8" Tie Spacing                   | As per table A.1.2. |                       |                 |                       | As per table A.1.2. |                      |                 |            | As per table A.1.2. |            |                 |             |            |            |             |            |             |
| Horizontal Reinforcement   | Block Height of 12" and 18"               | 10 M @ 450 (18)     |                       | 10 M @ 450 (18) |                       | 10 M @ 450 (18)     |                      | 10 M @ 450 (18) |            | 10 M @ 450 (18)     |            | 10 M @ 450 (18) |             |            |            |             |            |             |
| Horizontal Reinforcement   | Block Height of 16"                       | 10 M @ 400 (16)     |                       | 10 M @ 400 (16) |                       | 10 M @ 400 (16)     |                      | 10 M @ 400 (16) |            | 10 M @ 400 (16)     |            | 10 M @ 400 (16) |             |            |            |             |            |             |

**NOTES:**

1.  $S_{a,ICF}$  is equivalent spectral response acceleration for ICF walls as provided in Appendix A.
2. This table is to be used in conjunction with the "Design Limitations."
3. Provide two layers of the indicated horizontal and vertical distributed steel specified for 300mm (12") walls. Place each layer as shown in the rebar placement drawing.
4. All four sides of the building are to have a minimum number and length of shear walls that conforms to this table.
5. Use Table A.6 for buildings that do not meet the required wall length of this table.
6. Provide 2-15M concentrated reinforcement at each end of shear walls as shown in shear wall detail.
7. All concentrated reinforcement is to be continues to the bottom of the foundation wall. Provide lap splices as required.
8. Concentrated reinforcement is to be placed in accordance with Bar Placement Detail.

**INSULATING CONCRETE FORMS MANUFACTURERS ASSOCIATION**



**Table A.8.2400. Above Grade Shear Wall Length for Seismic Zone Classification,  $S_{a,ICF} \leq 0.16$  and Hourly Wind Pressure,  $0.5kPa < q_{1/50} \leq 0.75kPa$  (in a Building With Walkout Basement), where Building Area  $\leq 2400ft^2$**

| Wall Height m (ft)   | Seismic Zone Classification  |            |                       |             |                       |            |
|--|--|------------|-----------------------|-------------|-----------------------|------------|
|  | $S_{a,ICF} \leq 0.07$  |            | $S_{a,ICF} \leq 0.11$ |             | $S_{a,ICF} \leq 0.16$ |            |
| <b>Second Floor Walls of Two Story ICF Structure Supporting Wood Frame Roof (TYPE E)</b> |  |            |                       |             |                       |            |
|  | 6" & 8" Thick Wall   |            | 10" & 12" Thick Wall  |             | 6" & 8" Thick Wall    |            |
|  | Number and length of shear walls provided  |            |                       |             |                       |            |
| 2.44 (8)   | 1 x 7'-4"  | 2 x 3'-8"  | 3 x 2'-8"             | 1 x 7'-4"   | 2 x 3'-8"             | 3 x 2'-8"  |
| 2.75 (9)   | 1 x 7'-4"  | 2 x 3'-8"  | 3 x 2'-8"             | 1 x 7'-4"   | 2 x 3'-8"             | 3 x 2'-9"  |
| 3.05 (10)  | 1 x 7'-4"  | 2 x 3'-8"  | 3 x 2'-8"             | 1 x 7'-4"   | 2 x 4'-7"             | 3 x 3'-8"  |
|  | 6" & 8" Thick Wall   |            | 10" & 12" Thick Wall  |             | 6" & 8" Thick Wall    |            |
|  | Number and length of shear walls provided  |            |                       |             |                       |            |
| 2.44 (8)   | 1 x 7'-4"  | 2 x 3'-8"  | 3 x 2'-8"             | 1 x 7'-4"   | 2 x 3'-8"             | 3 x 2'-9"  |
| 2.75 (9)   | 1 x 7'-4"  | 2 x 3'-8"  | 3 x 2'-8"             | 1 x 7'-4"   | 2 x 3'-8"             | 3 x 2'-9"  |
| 3.05 (10)  | 1 x 7'-4"  | 2 x 3'-8"  | 3 x 2'-8"             | 1 x 7'-4"   | 2 x 4'-2"             | 3 x 3'-3"  |
| 3.66 (12)  | 1 x 7'-4"  | 2 x 3'-8"  | 3 x 2'-9"             | 1 x 7'-4"   | 2 x 4'-2"             | 3 x 3'-3"  |
| 4.27 (14)  | 1 x 7'-4"  | 2 x 4'-2"  | 3 x 3'-8"             | 1 x 7'-4"   | 2 x 5'-3"             | 3 x 3'-12" |
| 4.88 (16)  | 1 x 7'-4"  | 2 x 4'-7"  | 3 x 3'-8"             | 1 x 7'-4"   | 2 x 5'-12"            | 3 x 4'-7"  |
|  | <b>Main Floor Walls of One Story ICF Structure Supporting Wood Frame Roof (TYPE F)</b>                         |            |                       |             |                       |            |
|  | 6" & 8" Thick Wall   |            | 10" & 12" Thick Wall  |             | 6" & 8" Thick Wall    |            |
|  | Number and length of shear walls provided  |            |                       |             |                       |            |
| 2.44 (8)   | 1 x 7'-4"  | 2 x 3'-8"  | 3 x 2'-8"             | 1 x 7'-4"   | 2 x 3'-8"             | 3 x 2'-8"  |
| 2.75 (9)   | 1 x 7'-4"  | 2 x 3'-8"  | 3 x 2'-8"             | 1 x 7'-4"   | 2 x 3'-8"             | 3 x 2'-9"  |
| 3.05 (10)  | 1 x 7'-4"  | 2 x 3'-8"  | 3 x 2'-8"             | 1 x 7'-4"   | 2 x 4'-2"             | 3 x 3'-3"  |
| 3.66 (12)  | 1 x 7'-4"  | 2 x 3'-8"  | 3 x 2'-9"             | 1 x 7'-4"   | 2 x 4'-2"             | 3 x 3'-3"  |
| 4.27 (14)  | 1 x 7'-4"  | 2 x 4'-2"  | 3 x 3'-8"             | 1 x 7'-4"   | 2 x 5'-3"             | 3 x 3'-12" |
| 4.88 (16)  | 1 x 7'-4"  | 2 x 4'-7"  | 3 x 3'-8"             | 1 x 7'-4"   | 2 x 5'-12"            | 3 x 4'-7"  |
|  | <b>Main Floor Walls of Two Story Structure Supporting 2nd Story Wood Framed Walls, Floor and Roof (TYPE G)</b> |            |                       |             |                       |            |
|  | 6" & 8" Thick Wall   |            | 10" & 12" Thick Wall  |             | 6" & 8" Thick Wall    |            |
|  | Number and length of shear walls provided  |            |                       |             |                       |            |
| 2.44 (8)   | 1 x 7'-4"  | 2 x 4'-7"  | 3 x 3'-8"             | 1 x 9'-6"   | 2 x 6'-2"             | 3 x 4'-11" |
| 2.75 (9)   | 1 x 7'-4"  | 2 x 4'-7"  | 3 x 3'-8"             | 1 x 9'-6"   | 2 x 6'-2"             | 3 x 4'-11" |
| 3.05 (10)  | 1 x 7'-12"   | 2 x 5'-3"  | 3 x 3'-12"            | 1 x 10'-7"  | 2 x 6'-11"            | 3 x 5'-6"  |
| 3.66 (12)  | 1 x 7'-12"   | 2 x 5'-3"  | 3 x 4'-7"             | 1 x 10'-7"  | 2 x 6'-11"            | 3 x 5'-6"  |
| 4.27 (14)  | 1 x 8'-11"   | 2 x 5'-12" | 3 x 4'-11"            | 1 x 11'-8"  | 2 x 7'-10"            | 3 x 6'-5"  |
| 4.88 (16)  | 1 x 9'-2"  | 2 x 6'-5"  | 3 x 5'-1"             | 1 x 11'-12" | 2 x 8'-3"             | 3 x 6'-11" |
|  | <b>Main Floor Walls of Two Story ICF Structure Supporting Wood Frame Floors and Roof (TYPE H)</b>              |            |                       |             |                       |            |
|  | 6" & 8" Thick Wall   |            | 10" & 12" Thick Wall  |             | 6" & 8" Thick Wall    |            |
|  | Number and length of shear walls provided  |            |                       |             |                       |            |
| 2.44 (8)   | 1 x 8'-7"  | 2 x 5'-6"  | 3 x 4'-4"             | 1 x 11'-6"  | 2 x 7'-4"             | 3 x 5'-10" |
| 2.75 (9)   | 1 x 8'-11"   | 2 x 5'-12" | 3 x 4'-4"             | 1 x 11'-12" | 2 x 7'-8"             | 3 x 5'-12" |
| 3.05 (10)  | 1 x 10'-1"   | 2 x 6'-5"  | 3 x 5'-1"             | 1 x 12'-11" | 2 x 8'-9"             | 3 x 6'-9"  |
| 3.66 (12)  | 1 x 10'-7"   | 2 x 6'-11" | 3 x 5'-6"             | 1 x 13'-4"  | 2 x 9'-2"             | 3 x 7'-1"  |
| 4.27 (14)  | 1 x 10'-7"   | 2 x 7'-4"  | 3 x 5'-12"            | 1 x 13'-10" | 2 x 9'-2"             | 3 x 7'-4"  |
| 4.88 (16)  | 1 x 10'-7"   | 2 x 7'-4"  | 3 x 5'-12"            | 1 x 13'-10" | 2 x 9'-2"             | 3 x 7'-4"  |
|  | ICF with 6" Tie Spacing  |            | As per table A.1.1.   |             | As per table A.1.1.   |            |
|  | ICF with 8" Tie Spacing  |            | As per table A.1.2.   |             | As per table A.1.2.   |            |
|  | Block Height of 12" and 18"  |            | 10 M @ 450 (18)       |             | 10 M @ 450 (18)       |            |
|  | Block Height of 16"  |            | 10 M @ 400 (16)       |             | 10 M @ 400 (16)       |            |

**NOTES:**

1.  $S_{a,ICF}$  is equivalent spectral response acceleration for ICF walls as provided in Appendix A.
2. This table is to be used in conjunction with the "Design Limitations."
3. Provide two layers of the indicated horizontal and vertical distributed steel specified for 300mm (12") walls. Place each layer as shown in the rebar placement drawing.
4. All four sides of the building are to have a minimum number and length of shear walls that conforms to this table.
5. Use Table A.6 for buildings that do not meet the required wall length of this table.
6. Provide 2-15M concentrated reinforcement at each end of shear walls as shown in shear wall detail.
7. All concentrated reinforcement is to be continues to the bottom of the foundation wall. Provide lap splices as required.
8. Concentrated reinforcement is to be placed in accordance with Bar Placement Detail.

INSULATING CONCRETE FORMS MANUFACTURERS ASSOCIATION



**Table A.9.2400. Above Grade Shear Wall Length for Seismic Zone Classification,  $S_{a,ICF} \leq 0.16$  and Hourly Wind Pressure,  $0.75kPa < q_{1/50} \leq 1.05kPa$  (in a Building With Walkout Basement), where Building Area  $\leq 2400ft^2$**

| Wall Height m (ft)   | Seismic Zone Classification               |            |                       |             |                       |            |                      |            |            |             |            |            |             |            |            |             |            |            |
|--|---|------------|-----------------------|-------------|-----------------------|------------|----------------------|------------|------------|-------------|------------|------------|-------------|------------|------------|-------------|------------|------------|
|  | $S_{a,ICF} \leq 0.07$                     |            | $S_{a,ICF} \leq 0.11$ |             | $S_{a,ICF} \leq 0.16$ |            |                      |            |            |             |            |            |             |            |            |             |            |            |
| <b>Second Floor Walls of Two Story ICF Structure Supporting Wood Frame Roof (TYPE E)</b>                       |   |            |                       |             |                       |            |                      |            |            |             |            |            |             |            |            |             |            |            |
|  | 6" & 8" Thick Wall                        |            | 10" & 12" Thick Wall  |             | 6" & 8" Thick Wall    |            | 10" & 12" Thick Wall |            |            |             |            |            |             |            |            |             |            |            |
|  | Number and length of shear walls provided |            |                       |             |                       |            |                      |            |            |             |            |            |             |            |            |             |            |            |
| 2.44 (8)   | 1 x 7'-4"                                 | 2 x 3'-8"  | 3 x 2'-8"             | 1 x 7'-4"   | 2 x 3'-8"             | 3 x 2'-8"  | 1 x 7'-4"            | 2 x 3'-8"  | 3 x 2'-9"  | 1 x 7'-4"   | 2 x 3'-8"  | 3 x 2'-9"  | 1 x 7'-4"   | 2 x 4'-7"  | 3 x 3'-8"  | 1 x 7'-4"   | 2 x 4'-7"  | 3 x 3'-8"  |
| 2.75 (9)   | 1 x 7'-4"                                 | 2 x 3'-8"  | 3 x 2'-8"             | 1 x 7'-4"   | 2 x 3'-8"             | 3 x 2'-8"  | 1 x 7'-4"            | 2 x 3'-12" | 3 x 3'-11" | 1 x 7'-4"   | 2 x 4'-4"  | 3 x 3'-3"  | 1 x 7'-10"  | 2 x 4'-11" | 3 x 3'-12" | 1 x 8'-7"   | 2 x 5'-6"  | 3 x 4'-4"  |
| 3.05 (10)  | 1 x 7'-4"                                 | 2 x 3'-8"  | 3 x 2'-9"             | 1 x 7'-4"   | 2 x 3'-8"             | 3 x 2'-8"  | 1 x 7'-4"            | 2 x 4'-2"  | 3 x 3'-3"  | 1 x 7'-4"   | 2 x 4'-2"  | 3 x 3'-3"  | 1 x 7'-12"  | 2 x 5'-3"  | 3 x 3'-12" | 1 x 9'-8"   | 2 x 5'-6"  | 3 x 4'-2"  |
| 3.66 (12)  | 1 x 7'-4"                                 | 2 x 3'-8"  | 3 x 2'-9"             | 1 x 7'-4"   | 2 x 3'-12"            | 3 x 3'-11" | 1 x 7'-10"           | 2 x 5'-1"  | 3 x 3'-12" | 1 x 7'-12"  | 2 x 5'-3"  | 3 x 3'-12" | 1 x 9'-8"   | 2 x 6'-5"  | 3 x 5'-1"  | 1 x 10'-1"  | 2 x 6'-5"  | 3 x 5'-1"  |
| 4.27 (14)  | 1 x 7'-4"                                 | 2 x 4'-2"  | 3 x 3'-8"             | 1 x 7'-4"   | 2 x 4'-7"             | 3 x 3'-8"  | 1 x 9'-2"            | 2 x 5'-6"  | 3 x 4'-4"  | 1 x 9'-8"   | 2 x 6'-5"  | 3 x 4'-11" | 1 x 10'-7"  | 2 x 6'-11" | 3 x 5'-6"  | 1 x 11'-6"  | 2 x 7'-8"  | 3 x 5'-12" |
| 4.88 (16)  | 1 x 7'-4"                                 | 2 x 4'-7"  | 3 x 3'-8"             | 1 x 8'-3"   | 2 x 5'-1"             | 3 x 4'-2"  | 1 x 9'-2"            | 2 x 5'-12" | 3 x 4'-7"  | 1 x 10'-1"  | 2 x 6'-11" | 3 x 5'-3"  | 1 x 11'-0"  | 2 x 7'-4"  | 3 x 5'-12" | 1 x 12'-11" | 2 x 8'-7"  | 3 x 6'-9"  |
| <b>Main Floor Walls of One Story ICF Structure Supporting Wood Frame Roof (TYPE F)</b>                         |   |            |                       |             |                       |            |                      |            |            |             |            |            |             |            |            |             |            |            |
|  | 6" & 8" Thick Wall                        |            | 10" & 12" Thick Wall  |             | 6" & 8" Thick Wall    |            | 10" & 12" Thick Wall |            |            |             |            |            |             |            |            |             |            |            |
|  | Number and length of shear walls provided |            |                       |             |                       |            |                      |            |            |             |            |            |             |            |            |             |            |            |
| 2.44 (8)   | 1 x 7'-4"                                 | 2 x 3'-8"  | 3 x 2'-8"             | 1 x 7'-4"   | 2 x 3'-8"             | 3 x 2'-8"  | 1 x 7'-4"            | 2 x 3'-8"  | 3 x 2'-9"  | 1 x 7'-4"   | 2 x 3'-8"  | 3 x 2'-9"  | 1 x 7'-4"   | 2 x 4'-2"  | 3 x 3'-1"  | 1 x 7'-4"   | 2 x 4'-2"  | 3 x 3'-1"  |
| 2.75 (9)   | 1 x 7'-4"                                 | 2 x 3'-8"  | 3 x 2'-8"             | 1 x 7'-4"   | 2 x 3'-8"             | 3 x 2'-8"  | 1 x 7'-4"            | 2 x 3'-8"  | 3 x 2'-9"  | 1 x 7'-4"   | 2 x 3'-12" | 3 x 3'-11" | 1 x 7'-4"   | 2 x 4'-4"  | 3 x 3'-4"  | 1 x 7'-10"  | 2 x 4'-11" | 3 x 3'-12" |
| 3.05 (10)  | 1 x 7'-4"                                 | 2 x 3'-8"  | 3 x 2'-8"             | 1 x 7'-4"   | 2 x 3'-8"             | 3 x 2'-8"  | 1 x 7'-4"            | 2 x 4'-2"  | 3 x 3'-3"  | 1 x 7'-4"   | 2 x 4'-2"  | 3 x 3'-3"  | 1 x 8'-3"   | 2 x 5'-6"  | 3 x 4'-2"  | 1 x 8'-9"   | 2 x 5'-3"  | 3 x 3'-12" |
| 3.66 (12)  | 1 x 7'-4"                                 | 2 x 3'-8"  | 3 x 2'-9"             | 1 x 7'-4"   | 2 x 3'-12"            | 3 x 3'-11" | 1 x 7'-10"           | 2 x 5'-1"  | 3 x 3'-12" | 1 x 7'-12"  | 2 x 5'-3"  | 3 x 3'-12" | 1 x 9'-8"   | 2 x 6'-5"  | 3 x 5'-1"  | 1 x 10'-1"  | 2 x 6'-5"  | 3 x 5'-1"  |
| 4.27 (14)  | 1 x 7'-4"                                 | 2 x 4'-2"  | 3 x 3'-8"             | 1 x 7'-4"   | 2 x 4'-7"             | 3 x 3'-8"  | 1 x 9'-2"            | 2 x 5'-6"  | 3 x 4'-4"  | 1 x 9'-8"   | 2 x 6'-5"  | 3 x 4'-11" | 1 x 10'-7"  | 2 x 6'-11" | 3 x 5'-6"  | 1 x 11'-6"  | 2 x 7'-8"  | 3 x 5'-12" |
| 4.88 (16)  | 1 x 7'-4"                                 | 2 x 4'-7"  | 3 x 3'-8"             | 1 x 8'-3"   | 2 x 5'-1"             | 3 x 4'-2"  | 1 x 9'-2"            | 2 x 5'-12" | 3 x 4'-7"  | 1 x 10'-1"  | 2 x 6'-11" | 3 x 5'-3"  | 1 x 11'-0"  | 2 x 7'-4"  | 3 x 5'-12" | 1 x 12'-11" | 2 x 8'-7"  | 3 x 6'-9"  |
| <b>Main Floor Walls of Two Story Structure Supporting 2nd Story Wood Framed Walls, Floor and Roof (TYPE G)</b> |   |            |                       |             |                       |            |                      |            |            |             |            |            |             |            |            |             |            |            |
|  | 6" & 8" Thick Wall                        |            | 10" & 12" Thick Wall  |             | 6" & 8" Thick Wall    |            | 10" & 12" Thick Wall |            |            |             |            |            |             |            |            |             |            |            |
|  | Number and length of shear walls provided |            |                       |             |                       |            |                      |            |            |             |            |            |             |            |            |             |            |            |
| 2.44 (8)   | 1 x 7'-4"                                 | 2 x 4'-7"  | 3 x 3'-8"             | 1 x 7'-4"   | 2 x 4'-7"             | 3 x 3'-8"  | 1 x 9'-6"            | 2 x 6'-2"  | 3 x 4'-11" | 1 x 9'-2"   | 2 x 5'-12" | 3 x 4'-7"  | 1 x 11'-12" | 2 x 7'-10" | 3 x 5'-12" | 1 x 11'-12" | 2 x 7'-4"  | 3 x 5'-12" |
| 2.75 (9)   | 1 x 7'-4"                                 | 2 x 4'-7"  | 3 x 3'-8"             | 1 x 7'-8"   | 2 x 4'-11"            | 3 x 3'-8"  | 1 x 9'-8"            | 2 x 6'-2"  | 3 x 4'-7"  | 1 x 10'-1"  | 2 x 6'-5"  | 3 x 5'-1"  | 1 x 12'-5"  | 2 x 7'-10" | 3 x 5'-12" | 1 x 12'-7"  | 2 x 8'-3"  | 3 x 6'-5"  |
| 3.05 (10)  | 1 x 7'-12"                                | 2 x 5'-3"  | 3 x 3'-12"            | 1 x 7'-10"  | 2 x 5'-1"             | 3 x 3'-12" | 1 x 10'-7"           | 2 x 6'-11" | 3 x 5'-6"  | 1 x 10'-7"  | 2 x 6'-9"  | 3 x 5'-6"  | 1 x 13'-2"  | 2 x 8'-9"  | 3 x 6'-9"  | 1 x 13'-4"  | 2 x 8'-7"  | 3 x 6'-9"  |
| 3.66 (12)  | 1 x 8'-7"                                 | 2 x 5'-10" | 3 x 4'-7"             | 1 x 8'-7"   | 2 x 5'-10"            | 3 x 4'-7"  | 1 x 11'-4"           | 2 x 7'-8"  | 3 x 5'-12" | 1 x 11'-4"  | 2 x 7'-8"  | 3 x 5'-12" | 1 x 13'-10" | 2 x 9'-6"  | 3 x 7'-4"  | 1 x 13'-10" | 2 x 9'-6"  | 3 x 7'-4"  |
| 4.27 (14)  | 1 x 8'-11"                                | 2 x 5'-12" | 3 x 4'-11"            | 1 x 9'-6"   | 2 x 6'-5"             | 3 x 4'-11" | 1 x 11'-8"           | 2 x 7'-10" | 3 x 6'-5"  | 1 x 12'-5"  | 2 x 8'-3"  | 3 x 6'-5"  | 1 x 14'-3"  | 2 x 9'-8"  | 3 x 7'-10" | 1 x 15'-0"  | 2 x 10'-5" | 3 x 8'-3"  |
| 4.88 (16)  | 1 x 9'-2"                                 | 2 x 6'-5"  | 3 x 5'-1"             | 1 x 10'-1"  | 2 x 6'-9"             | 3 x 5'-3"  | 1 x 11'-12"          | 2 x 8'-3"  | 3 x 6'-11" | 1 x 12'-11" | 2 x 8'-9"  | 3 x 6'-11" | 1 x 14'-3"  | 2 x 9'-8"  | 3 x 7'-10" | 1 x 15'-8"  | 2 x 10'-7" | 3 x 8'-7"  |
| <b>Main Floor Walls of Two Story ICF Structure Supporting Wood Frame Floors and Roof (TYPE H)</b>              |   |            |                       |             |                       |            |                      |            |            |             |            |            |             |            |            |             |            |            |
|  | 6" & 8" Thick Wall                        |            | 10" & 12" Thick Wall  |             | 6" & 8" Thick Wall    |            | 10" & 12" Thick Wall |            |            |             |            |            |             |            |            |             |            |            |
|  | Number and length of shear walls provided |            |                       |             |                       |            |                      |            |            |             |            |            |             |            |            |             |            |            |
| 2.44 (8)   | 1 x 8'-7"                                 | 2 x 5'-6"  | 3 x 4'-4"             | 1 x 9'-2"   | 2 x 5'-10"            | 3 x 4'-7"  | 1 x 11'-6"           | 2 x 7'-4"  | 3 x 5'-10" | 1 x 12'-3"  | 2 x 7'-10" | 3 x 5'-12" | 1 x 14'-9"  | 2 x 9'-2"  | 3 x 7'-4"  | 1 x 15'-2"  | 2 x 10'-1" | 3 x 7'-10" |
| 2.75 (9)   | 1 x 8'-11"                                | 2 x 5'-12" | 3 x 4'-4"             | 1 x 10'-1"  | 2 x 6'-5"             | 3 x 4'-11" | 1 x 11'-12"          | 2 x 7'-8"  | 3 x 5'-12" | 1 x 12'-11" | 2 x 8'-3"  | 3 x 6'-5"  | 1 x 15'-2"  | 2 x 10'-1" | 3 x 7'-10" | 1 x 16'-1"  | 2 x 10'-7" | 3 x 8'-3"  |
| 3.05 (10)  | 1 x 10'-1"                                | 2 x 6'-5"  | 3 x 5'-1"             | 1 x 10'-1"  | 2 x 6'-5"             | 3 x 5'-1"  | 1 x 12'-11"          | 2 x 8'-9"  | 3 x 6'-9"  | 1 x 13'-10" | 2 x 8'-9"  | 3 x 6'-11" | 1 x 16'-1"  | 2 x 10'-7" | 3 x 8'-3"  | 1 x 17'-0"  | 2 x 11'-0" | 3 x 8'-9"  |
| 3.66 (12)  | 1 x 10'-7"                                | 2 x 6'-11" | 3 x 5'-6"             | 1 x 10'-7"  | 2 x 7'-1"             | 3 x 5'-6"  | 1 x 13'-4"           | 2 x 9'-2"  | 3 x 7'-1"  | 1 x 13'-10" | 2 x 9'-2"  | 3 x 7'-4"  | 1 x 16'-7"  | 2 x 11'-4" | 3 x 8'-11" | 1 x 17'-6"  | 2 x 11'-6" | 3 x 9'-2"  |
| 4.27 (14)  | 1 x 10'-7"                                | 2 x 7'-4"  | 3 x 5'-12"            | 1 x 11'-6"  | 2 x 7'-10"            | 3 x 6'-5"  | 1 x 13'-10"          | 2 x 9'-2"  | 3 x 7'-4"  | 1 x 15'-2"  | 2 x 10'-1" | 3 x 8'-3"  | 1 x 16'-10" | 2 x 11'-6" | 3 x 9'-2"  | 1 x 19'-4"  | 2 x 12'-5" | 3 x 10'-1" |
| 4.88 (16)  | 1 x 10'-7"                                | 2 x 7'-4"  | 3 x 5'-12"            | 1 x 11'-12" | 2 x 8'-3"             | 3 x 6'-5"  | 1 x 13'-10"          | 2 x 9'-2"  | 3 x 7'-4"  | 1 x 16'-1"  | 2 x 11'-0" | 3 x 8'-3"  | 1 x 16'-10" | 2 x 11'-6" | 3 x 9'-2"  | 1 x 19'-4"  | 2 x 13'-2" | 3 x 10'-5" |
| Vertical Reinforcement   | ICF with 6" Tie Spacing                   |            | As per table A.1.1.   |             | As per table A.1.1.   |            | As per table A.1.1.  |            |            |             |            |            |             |            |            |             |            |            |
|  | ICF with 8" Tie Spacing                   |            | As per table A.1.2.   |             | As per table A.1.2.   |            | As per table A.1.2.  |            |            |             |            |            |             |            |            |             |            |            |
| Horizontal Reinforcement   | Block Height of 12" and 18"               |            | 10 M @ 450 (18)       |             | 10 M @ 450 (18)       |            | 10 M @ 450 (18)      |            |            |             |            |            |             |            |            |             |            |            |
|  | Block Height of 16"                       |            | 10 M @ 400 (16)       |             | 10 M @ 400 (16)       |            | 10 M @ 400 (16)      |            |            |             |            |            |             |            |            |             |            |            |

**NOTES:**

- $S_{a,ICF}$  is equivalent spectral response acceleration for ICF walls as provided in Appendix A.
- This table is to be used in conjunction with the "Design Limitations."
- Provide two layers of the indicated horizontal and vertical distributed steel specified for 300mm (12") walls. Place each layer as shown in the rebar placement drawing.
- All four sides of the building are to have a minimum number and length of shear walls that conforms to this table.
- Use Table A.6 for buildings that do not meet the required wall length of this table.
- Provide 2-15M concentrated reinforcement at each end of shear walls as shown in shear wall detail.
- All concentrated reinforcement is to be continues to the bottom of the foundation wall. Provide lap splices as required.
- Concentrated reinforcement is to be placed in accordance with Bar Placement Detail.

INSULATING CONCRETE FORMS MANUFACTURERS ASSOCIATION



**Table A.10.2400. Above Grade Shear Wall Length for Seismic Zone Classification,  $S_{a,ICF} > 0.16$  and Hourly Wind Pressure,  $q_{1/50} \leq 1.05kPa$  (in a Building With Walkout Basement), where Building Area  $\leq 2400ft^2$**

| Wall Height m (ft)   | Seismic Zone Classification               |          |                       |          |                       |          |                       |          |
|--|---|----------|-----------------------|----------|-----------------------|----------|-----------------------|----------|
|  | $S_{a,ICF} \leq 0.16$                     |          | $S_{a,ICF} \leq 0.31$ |          | $S_{a,ICF} \leq 0.53$ |          | $S_{a,ICF} \leq 0.79$ |          |
| <b>Second Floor Walls of Two Story ICF Structure Supporting Wood Frame Roof (TYPE E)</b>                       |   |          |                       |          |                       |          |                       |          |
|  | 6" & 8" Thick Wall                        |          | 10" & 12" Thick Wall  |          | 6" & 8" Thick Wall    |          | 10" & 12" Thick Wall  |          |
|  | Number and length of shear walls provided |          |                       |          |                       |          |                       |          |
| 2.44 (8)   | 1x7'-4"                                   | 2x3'-8"  | 1x7'-4"               | 2x3'-8"  | 1x8'-3"               | 2x5'-6"  | 1x10'-1"              | 2x6'-11" |
| 2.75 (9)   | 1x7'-4"                                   | 2x3'-8"  | 1x7'-4"               | 2x3'-8"  | 1x8'-3"               | 2x5'-6"  | 1x10'-1"              | 2x6'-11" |
| 3.05 (10)  | 1x7'-4"                                   | 2x3'-8"  | 1x7'-4"               | 2x3'-8"  | 1x8'-3"               | 2x5'-6"  | 1x10'-1"              | 2x6'-11" |
| 3.66 (12)  | 1x7'-4"                                   | 2x3'-8"  | 1x7'-4"               | 2x3'-8"  | 1x8'-3"               | 2x5'-6"  | 1x10'-1"              | 2x6'-11" |
| 4.27 (14)  | 1x7'-4"                                   | 2x3'-8"  | 1x7'-4"               | 2x3'-8"  | 1x8'-3"               | 2x5'-6"  | 1x10'-1"              | 2x6'-11" |
| 4.88 (16)  | 1x7'-4"                                   | 2x3'-8"  | 1x7'-4"               | 2x3'-8"  | 1x8'-3"               | 2x5'-6"  | 1x10'-1"              | 2x6'-11" |
| <b>Main Floor Walls of One Story ICF Structure Supporting Wood Frame Roof (TYPE F)</b>                         |   |          |                       |          |                       |          |                       |          |
|  | 6" & 8" Thick Wall                        |          | 10" & 12" Thick Wall  |          | 6" & 8" Thick Wall    |          | 10" & 12" Thick Wall  |          |
|  | Number and length of shear walls provided |          |                       |          |                       |          |                       |          |
| 2.44 (8)   | 1x7'-4"                                   | 2x3'-8"  | 1x7'-4"               | 2x3'-8"  | 1x8'-3"               | 2x5'-6"  | 1x10'-1"              | 2x6'-11" |
| 2.75 (9)   | 1x7'-4"                                   | 2x3'-8"  | 1x7'-4"               | 2x3'-8"  | 1x8'-3"               | 2x5'-6"  | 1x10'-1"              | 2x6'-11" |
| 3.05 (10)  | 1x7'-4"                                   | 2x3'-8"  | 1x7'-4"               | 2x3'-8"  | 1x8'-3"               | 2x5'-6"  | 1x10'-1"              | 2x6'-11" |
| 3.66 (12)  | 1x7'-4"                                   | 2x3'-8"  | 1x7'-4"               | 2x3'-8"  | 1x8'-3"               | 2x5'-6"  | 1x10'-1"              | 2x6'-11" |
| 4.27 (14)  | 1x7'-4"                                   | 2x3'-8"  | 1x7'-4"               | 2x3'-8"  | 1x8'-3"               | 2x5'-6"  | 1x10'-1"              | 2x6'-11" |
| 4.88 (16)  | 1x7'-4"                                   | 2x3'-8"  | 1x7'-4"               | 2x3'-8"  | 1x8'-3"               | 2x5'-6"  | 1x10'-1"              | 2x6'-11" |
| <b>Main Floor Walls of Two Story Structure Supporting 2nd Story Wood Framed Walls, Floor and Roof (TYPE G)</b> |   |          |                       |          |                       |          |                       |          |
|  | 6" & 8" Thick Wall                        |          | 10" & 12" Thick Wall  |          | 6" & 8" Thick Wall    |          | 10" & 12" Thick Wall  |          |
|  | Number and length of shear walls provided |          |                       |          |                       |          |                       |          |
| 2.44 (8)   | 1x9'-2"                                   | 2x5'-12" | 1x9'-2"               | 2x5'-12" | 1x12'-11"             | 2x8'-9"  | 1x12'-11"             | 2x8'-9"  |
| 2.75 (9)   | 1x10'-1"                                  | 2x6'-5"  | 1x10'-1"              | 2x6'-5"  | 1x13'-10"             | 2x9'-2"  | 1x13'-10"             | 2x9'-2"  |
| 3.05 (10)  | 1x10'-1"                                  | 2x6'-5"  | 1x10'-1"              | 2x6'-5"  | 1x13'-10"             | 2x9'-2"  | 1x13'-10"             | 2x9'-2"  |
| 3.66 (12)  | 1x10'-1"                                  | 2x6'-5"  | 1x10'-1"              | 2x6'-5"  | 1x13'-10"             | 2x9'-2"  | 1x13'-10"             | 2x9'-2"  |
| 4.27 (14)  | 1x10'-1"                                  | 2x6'-5"  | 1x10'-1"              | 2x6'-5"  | 1x13'-10"             | 2x9'-2"  | 1x13'-10"             | 2x9'-2"  |
| 4.88 (16)  | 1x10'-1"                                  | 2x6'-5"  | 1x10'-1"              | 2x6'-5"  | 1x13'-10"             | 2x9'-2"  | 1x13'-10"             | 2x9'-2"  |
| <b>Main Floor Walls of Two Story ICF Structure Supporting Wood Frame Floors and Roof (TYPE H)</b>              |   |          |                       |          |                       |          |                       |          |
|  | 6" & 8" Thick Wall                        |          | 10" & 12" Thick Wall  |          | 6" & 8" Thick Wall    |          | 10" & 12" Thick Wall  |          |
|  | Number and length of shear walls provided |          |                       |          |                       |          |                       |          |
| 2.44 (8)   | 1x11'-0"                                  | 2x8'-3"  | 1x11'-0"              | 2x8'-3"  | 1x15'-8"              | 2x11'-0" | 1x15'-8"              | 2x11'-0" |
| 2.75 (9)   | 1x11'-0"                                  | 2x8'-3"  | 1x11'-0"              | 2x8'-3"  | 1x15'-8"              | 2x11'-0" | 1x15'-8"              | 2x11'-0" |
| 3.05 (10)  | 1x11'-0"                                  | 2x8'-3"  | 1x11'-0"              | 2x8'-3"  | 1x15'-8"              | 2x11'-0" | 1x15'-8"              | 2x11'-0" |
| 3.66 (12)  | 1x11'-0"                                  | 2x8'-3"  | 1x11'-0"              | 2x8'-3"  | 1x15'-8"              | 2x11'-0" | 1x15'-8"              | 2x11'-0" |
| 4.27 (14)  | 1x11'-0"                                  | 2x8'-3"  | 1x11'-0"              | 2x8'-3"  | 1x15'-8"              | 2x11'-0" | 1x15'-8"              | 2x11'-0" |
| 4.88 (16)  | 1x11'-0"                                  | 2x8'-3"  | 1x11'-0"              | 2x8'-3"  | 1x15'-8"              | 2x11'-0" | 1x15'-8"              | 2x11'-0" |
| <b>Vertical Reinforcement</b>  |   |          |                       |          |                       |          |                       |          |
|  | ICF with 6" Tie Spacing                   |          | As per table A.2.1    |          | As per table A.2.1    |          | As per table A.2.1    |          |
|  | ICF with 8" Tie Spacing                   |          | As per table A.2.2    |          | As per table A.2.2    |          | As per table A.2.2    |          |
| <b>Horizontal Reinforcement</b>  |   |          |                       |          |                       |          |                       |          |
|  | Block Height of 12" and 18"               |          | As per table A.2.1    |          | As per table A.2.1    |          | As per table A.2.1    |          |
|  | Block Height of 10"                       |          | As per table A.2.2    |          | As per table A.2.2    |          | As per table A.2.2    |          |

**NOTES:**

1.  $S_{a,ICF}$  is equivalent spectral response acceleration for ICF walls as provided in Appendix A.
2. This table is to be used in conjunction with the "Design Limitations."
3. Provide two layers of the indicated horizontal and vertical distributed steel specified for 300mm (12") walls. Place each layer as shown in the rebar placement drawing.
4. All four sides of the building are to have a minimum number and length of shear walls that conforms to this table.
5. Provide 2-15M concentrated reinforcement at each end of shear walls as shown in shear wall detail.
6. All concentrated reinforcement is to be continues to the bottom of the foundation wall. Provide lap splices as required.
7. Concentrated reinforcement is to be placed in accordance with Bar Placement Detail.
8. Horizontal reinforcement in shear walls where  $S_{a,ICF} > 0.16$  must be anchored using a standard 180° hook around vertical end bars.
9. When using this table for  $S_{a,ICF} \leq 0.16$ , use the vertical and horizontal distributed steel in Tables A.2.1, or A.2.2.

**INSULATING CONCRETE FORMS MANUFACTURERS ASSOCIATION**

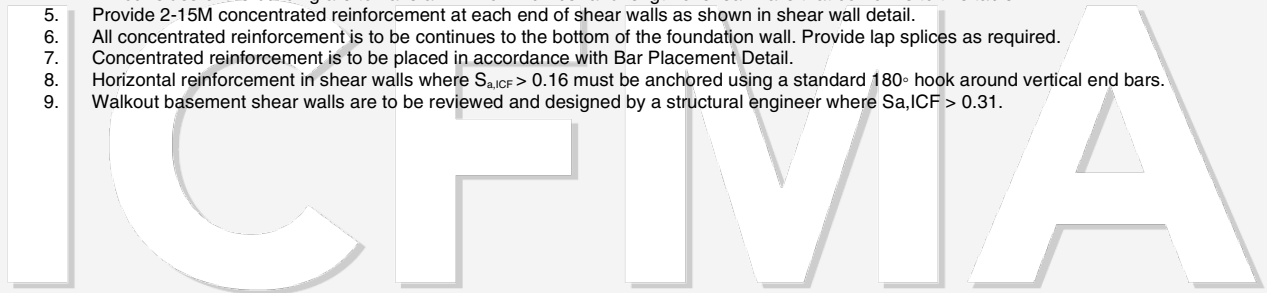

**Table A. 11.2400. – Above Grade Walkout Basement Shear Wall Length for Seismic Zone Classification,  $S_{a,ICF} \leq 0.31$  and Hourly Wind Pressure,  $q_{1/50} \leq 1.05kPa$ , where Building Area  $\leq 2400ft^2$**

| Wall Height m (ft)  | Seismic Zone Classification               |                           |                            |                            |                            |                             |                             |                             |
|---|---|---------------------------|----------------------------|----------------------------|----------------------------|-----------------------------|-----------------------------|-----------------------------|
|   | $S_{a,ICF} \leq 0.07$                     |                           | $S_{a,ICF} \leq 0.11$      |                            | $S_{a,ICF} \leq 0.16$      |                             | $S_{a,ICF} \leq 0.31$       |                             |
| <b>Walkout Basement Wall of a Single Story ICF Structure Supporting Wood Framed Roof (TYPE W1)</b>  |   |                           |                            |                            |                            |                             |                             |                             |
|   | 6" & 8" Thick Wall                        | 10" & 12" Thick Wall      | 6" & 8" Thick Wall         | 10" & 12" Thick Wall       | 6" & 8" Thick Wall         | 10" & 12" Thick Wall        | 6" & 8" Thick Wall          | 10" & 12" Thick Wall        |
|   | Number and length of shear walls provided |                           |                            |                            |                            |                             |                             |                             |
| 2.44 (8)  | 1x7'-0" 2x5'-1" 3x4'-2"                   | 1x7'-10" 2x5'-6" 3x4'-2"  | 1x9'-2" 2x6'-5" 3x5'-1"    | 1x9'-8" 2x6'-11" 3x5'-6"   | 1x11'-6" 2x7'-10" 3x6'-5"  | 1x11'-12" 2x8'-3" 3x6'-5"   | 1x16'-7" 2x11'-6" 3x9'-2"   | 1x17'-6" 2x11'-12" 3x9'-3"  |
| 2.75 (9)  | 1x7'-5" 2x5'-1" 3x4'-2"                   | 1x8'-3" 2x5'-6" 3x4'-7"   | 1x9'-8" 2x6'-6" 3x5'-6"    | 1x10'-1" 2x6'-11" 3x5'-6"  | 1x11'-6" 2x8'-3" 3x6'-5"   | 1x12'-3" 2x8'-3" 3x6'-9"    | 1x16'-7" 2x11'-6" 3x9'-2"   | 1x17'-6" 2x11'-12" 3x9'-8"  |
| 3.05 (10)   | 1x7'-10" 2x5'-6" 3x4'-2"                  | 1x8'-3" 2x5'-12" 3x4'-7"  | 1x9'-9" 2x6'-11" 3x5'-6"   | 1x10'-2" 2x7'-0" 3x5'-6"   | 1x11'-12" 2x8'-3" 3x6'-11" | 1x12'-6" 2x8'-9" 3x6'-11"   | 1x17'-0" 2x11'-12" 3x9'-8"  | 1x17'-11" 2x12'-5" 3x10'-1" |
| 3.66 (12)   | 1x8'-3" 2x5'-6" 3x4'-7"                   | 1x9'-2" 2x5'-12" 3x5'-1"  | 1x10'-5" 2x7'-4" 3x5'-12"  | 1x11'-0" 2x7'-4" 3x5'-12"  | 1x12'-6" 2x8'-9" 3x7'-4"   | 1x13'-4" 2x9'-2" 3x7'-4"    | 1x17'-11" 2x12'-5" 3x10'-1" | 1x19'-4" 2x13'-0" 3x10'-7"  |
| <b>Walkout Basement Walls of a Two Story Wood Framed Structure Supporting Wood Frame Floors and Roof (TYPE W2)</b>                              |   |                           |                            |                            |                            |                             |                             |                             |
|   | 6" & 8" Thick Wall                        | 10" & 12" Thick Wall      | 6" & 8" Thick Wall         | 10" & 12" Thick Wall       | 6" & 8" Thick Wall         | 10" & 12" Thick Wall        | 6" & 8" Thick Wall          | 10" & 12" Thick Wall        |
|   | Number and length of shear walls provided |                           |                            |                            |                            |                             |                             |                             |
| 2.44 (8)  | 1x9'-0" 2x6'-3" 3x5'-0"                   | 1x9'-0" 2x6'-3" 3x5'-0"   | 1x9'-8" 2x6'-11" 3x5'-6"   | 1x9'-8" 2x6'-11" 3x5'-6"   | 1x11'-12" 2x8'-3" 3x6'-5"  | 1x11'-12" 2x8'-3" 3x6'-5"   | 1x16'-7" 2x11'-6" 3x9'-2"   | 1x16'-7" 2x11'-6" 3x9'-2"   |
| 2.75 (9)  | 1x9'-3" 2x6'-3" 3x5'-1"                   | 1x9'-3" 2x6'-3" 3x5'-1"   | 1x10'-1" 2x7'-4" 3x5'-6"   | 1x10'-1" 2x7'-4" 3x5'-6"   | 1x11'-12" 2x8'-7" 3x6'-9"  | 1x11'-12" 2x8'-7" 3x6'-9"   | 1x17'-0" 2x11'-12" 3x9'-6"  | 1x17'-0" 2x11'-12" 3x9'-6"  |
| 3.05 (10)   | 1x9'-6" 2x6'-5" 3x5'-3"                   | 1x9'-6" 2x6'-5" 3x5'-3"   | 1x10'-1" 2x7'-4" 3x5'-6"   | 1x10'-1" 2x7'-4" 3x5'-6"   | 1x12'-5" 2x8'-7" 3x6'-9"   | 1x12'-5" 2x8'-7" 3x6'-9"    | 1x17'-6" 2x12'-3" 3x9'-8"   | 1x17'-6" 2x12'-3" 3x9'-8"   |
| 3.66 (12)   | 1x10'-0" 2x7'-0" 3x5'-6"                  | 1x10'-0" 2x7'-0" 3x5'-6"  | 1x10'-7" 2x7'-4" 3x5'-12"  | 1x10'-7" 2x7'-4" 3x5'-12"  | 1x12'-11" 2x8'-9" 3x7'-1"  | 1x12'-11" 2x8'-9" 3x7'-1"   | 1x17'-11" 2x12'-5" 3x10'-1" | 1x17'-11" 2x12'-5" 3x10'-1" |
| <b>Walkout Basement Wall of a Two Story Building with Main Floor ICF Walls Supporting 2nd Story Wood Framed Walls, Floor and Roof (TYPE W3)</b> |   |                           |                            |                            |                            |                             |                             |                             |
|   | 6" & 8" Thick Wall                        | 10" & 12" Thick Wall      | 6" & 8" Thick Wall         | 10" & 12" Thick Wall       | 6" & 8" Thick Wall         | 10" & 12" Thick Wall        | 6" & 8" Thick Wall          | 10" & 12" Thick Wall        |
|   | Number and length of shear walls provided |                           |                            |                            |                            |                             |                             |                             |
| 2.44 (8)  | 1x9'-2" 2x6'-5" 3x5'-3"                   | 1x9'-2" 2x6'-9" 3x5'-3"   | 1x11'-6" 2x8'-3" 3x6'-5"   | 1x11'-6" 2x8'-3" 3x6'-5"   | 1x13'-10" 2x9'-8" 3x7'-12" | 1x14'-3" 2x9'-8" 3x7'-12"   | 1x19'-4" 2x13'-10" 3x11'-0" | 1x20'-3" 2x13'-10" 3x11'-0" |
| 2.75 (9)  | 1x9'-2" 2x6'-9" 3x5'-3"                   | 1x9'-2" 2x6'-9" 3x5'-3"   | 1x11'-6" 2x8'-3" 3x6'-5"   | 1x11'-12" 2x8'-3" 3x6'-5"  | 1x14'-9" 2x9'-8" 3x7'-12"  | 1x14'-9" 2x10'-1" 3x7'-12"  | 1x19'-9" 2x13'-10" 3x11'-4" | 1x20'-3" 2x14'-3" 3x11'-4"  |
| 3.05 (10)   | 1x9'-6" 2x6'-9" 3x5'-3"                   | 1x9'-8" 2x6'-9" 3x5'-3"   | 1x11'-12" 2x8'-3" 3x6'-9"  | 1x11'-12" 2x8'-3" 3x6'-9"  | 1x14'-9" 2x10'-1" 3x7'-12" | 1x14'-9" 2x10'-1" 3x8'-3"   | 1x20'-3" 2x13'-10" 3x11'-4" | 1x20'-8" 2x14'-3" 3x11'-6"  |
| 3.66 (12)   | 1x10'-1" 2x7'-0" 3x5'-6"                  | 1x10'-1" 2x7'-0" 3x5'-6"  | 1x12'-5" 2x8'-9" 3x6'-11"  | 1x12'-5" 2x8'-9" 3x6'-11"  | 1x15'-0" 2x10'-5" 3x8'-3"  | 1x15'-2" 2x10'-7" 3x8'-7"   | 1x21'-2" 2x14'-9" 3x11'-12" | 1x21'-7" 2x15'-2" 3x12'-0"  |
| <b>Walkout Basement Wall of Two Story ICF Structure Supporting Wood Frame Floors and Roof (TYPE W4)</b>   |   |                           |                            |                            |                            |                             |                             |                             |
|   | 6" & 8" Thick Wall                        | 10" & 12" Thick Wall      | 6" & 8" Thick Wall         | 10" & 12" Thick Wall       | 6" & 8" Thick Wall         | 10" & 12" Thick Wall        | 6" & 8" Thick Wall          | 10" & 12" Thick Wall        |
|   | Number and length of shear walls provided |                           |                            |                            |                            |                             |                             |                             |
| 2.44 (8)  | 1x10'-1" 2x7'-0" 3x5'-10"                 | 1x11'-0" 2x7'-4" 3x5'-10" | 1x12'-11" 2x9'-2" 3x7'-4"  | 1x13'-6" 2x9'-2" 3x7'-6"   | 1x15'-8" 2x11'-0" 3x8'-9"  | 1x16'-7" 2x11'-6" 3x9'-2"   | 1x22'-1" 2x15'-8" 3x12'-5"  | 1x23'-3" 2x16'-7" 3x13'-0"  |
| 2.75 (9)  | 1x10'-7" 2x7'-4" 3x5'-10"                 | 1x11'-0" 2x7'-4" 3x5'-12" | 1x13'-10" 2x9'-2" 3x7'-4"  | 1x13'-10" 2x9'-8" 3x7'-10" | 1x16'-7" 2x11'-1" 3x9'-2"  | 1x16'-9" 2x11'-8" 3x9'-4"   | 1x23'-0" 2x15'-9" 3x12'-11" | 1x23'-11" 2x16'-7" 3x13'-4" |
| 3.05 (10)   | 1x10'-7" 2x7'-4" 3x5'-10"                 | 1x11'-0" 2x7'-8" 3x6'-3"  | 1x13'-10" 2x9'-3" 3x7'-10" | 1x14'-0" 2x9'-8" 3x7'-10"  | 1x16'-7" 2x11'-6" 3x9'-2"  | 1x17'-1" 2x11'-12" 3x9'-8"  | 1x23'-0" 2x16'-7" 3x13'-0"  | 1x24'-3" 2x16'-9" 3x13'-10" |
| 3.66 (12)   | 1x11'-0" 2x7'-8" 3x6'-2"                  | 1x11'-6" 2x7'-10" 3x6'-5" | 1x14'-0" 2x9'-8" 3x7'-10"  | 1x14'-0" 2x10'-1" 3x8'-3"  | 1x17'-0" 2x11'-12" 3x9'-8" | 1x17'-11" 2x12'-5" 3x10'-1" | 1x23'-11" 2x16'-8" 3x13'-6" | 1x25'-3" 2x17'-6" 3x14'-3"  |
| Vertical Reinforcement  | 6", 8" and 10" thick wall                 | 15 M @ 300 (12)           | 15 M @ 300 (12)            | 15 M @ 300 (12)            | 15 M @ 300 (12)            | 15 M @ 300 (12)             | 15 M @ 300 (12)             | 15 M @ 300 (12)             |
| Horizontal Reinforcement  | 12" thick wall                            | 10 M @ 300 (12)           | 10 M @ 300 (12)            | 10 M @ 300 (12)            | 10 M @ 300 (12)            | 10 M @ 300 (12)             | 10 M @ 300 (12)             | 10 M @ 300 (12)             |
|   | Block Height of 12" and 18"               | 10 M @ 450 (18)           | 10 M @ 450 (18)            | 10 M @ 450 (18)            | 10 M @ 450 (18)            | 10 M @ 450 (18)             | 10 M @ 450 (18)             | 10 M @ 450 (18)             |
|   | Block Height of 16"                       | 10 M @ 400 (16)           | 10 M @ 400 (16)            | 10 M @ 400 (16)            | 10 M @ 400 (16)            | 10 M @ 400 (16)             | 10 M @ 400 (16)             | 10 M @ 400 (16)             |

**NOTES:**

1.  $S_{a,ICF}$  is equivalent spectral response acceleration for ICF walls as provided in Appendix A.
2. This table is to be used in conjunction with the "Design Limitations."
3. Provide two layers of the indicated horizontal and vertical distributed steel specified for 300mm (12") walls. Place each layer as shown in the rebar placement drawing.
4. All four sides of the building are to have a minimum number and length of shear walls that conforms to this table.
5. Provide 2-15M concentrated reinforcement at each end of shear walls as shown in shear wall detail.
6. All concentrated reinforcement is to be continues to the bottom of the foundation wall. Provide lap splices as required.
7. Concentrated reinforcement is to be placed in accordance with Bar Placement Detail.
8. Horizontal reinforcement in shear walls where  $S_{a,ICF} > 0.16$  must be anchored using a standard 180° hook around vertical end bars.
9. Walkout basement shear walls are to be reviewed and designed by a structural engineer where  $S_{a,ICF} > 0.31$ .



# INSULATING CONCRETE FORMS MANUFACTURERS ASSOCIATION



**Table A.3.1600. Above Grade Shear Wall Length for Seismic Zone Classification,  $S_{a,ICF} \leq 0.16$  and Hourly Wind Pressure,  $q_{1/50} \leq 0.5kPa$  (in a Building Without Walkout Basement), where Building Area  $\leq 1600ft^2$**

| Wall Height m (ft)   | Seismic Zone Classification               |                     |                       |           |                       |           |
|--|---|---------------------|-----------------------|-----------|-----------------------|-----------|
|  | $S_{a,ICF} \leq 0.07$                     |                     | $S_{a,ICF} \leq 0.11$ |           | $S_{a,ICF} \leq 0.16$ |           |
| <b>Second Floor Walls of Two Story ICF Structure Supporting Wood Frame Roof (TYPE A)</b>                       |   |                     |                       |           |                       |           |
|  | 6" & 8" Thick Wall                        |                     | 10" & 12" Thick Wall  |           | 6" & 8" Thick Wall    |           |
|  | Number and length of shear walls provided |                     |                       |           |                       |           |
| 2.44 (8)   | 1 x 6'-5"                                 | 2 x 3'-2"           | 3 x 2'-8"             | 1 x 6'-5" | 2 x 3'-2"             | 3 x 2'-8" |
| 2.75 (9)   | 1 x 6'-5"                                 | 2 x 3'-2"           | 3 x 2'-8"             | 1 x 6'-5" | 2 x 3'-2"             | 3 x 2'-8" |
| 3.05 (10)  | 1 x 6'-5"                                 | 2 x 3'-2"           | 3 x 2'-8"             | 1 x 6'-5" | 2 x 3'-2"             | 3 x 2'-8" |
| <b>Main Floor Walls of One Story ICF Structure Supporting Wood Frame Roof (TYPE B)</b>                         |   |                     |                       |           |                       |           |
|  | 6" & 8" Thick Wall                        |                     | 10" & 12" Thick Wall  |           | 6" & 8" Thick Wall    |           |
|  | Number and length of shear walls provided |                     |                       |           |                       |           |
| 2.44 (8)   | 1 x 6'-5"                                 | 2 x 3'-2"           | 3 x 2'-8"             | 1 x 6'-5" | 2 x 3'-2"             | 3 x 2'-8" |
| 2.75 (9)   | 1 x 6'-5"                                 | 2 x 3'-2"           | 3 x 2'-8"             | 1 x 6'-5" | 2 x 3'-2"             | 3 x 2'-8" |
| 3.05 (10)  | 1 x 6'-5"                                 | 2 x 3'-2"           | 3 x 2'-8"             | 1 x 6'-5" | 2 x 3'-2"             | 3 x 2'-8" |
| 3.66 (12)  | 1 x 6'-5"                                 | 2 x 3'-2"           | 3 x 2'-8"             | 1 x 6'-5" | 2 x 3'-2"             | 3 x 2'-8" |
| 4.27 (14)  | 1 x 6'-5"                                 | 2 x 3'-2"           | 3 x 2'-8"             | 1 x 6'-5" | 2 x 3'-2"             | 3 x 2'-8" |
| 4.88 (16)  | 1 x 6'-5"                                 | 2 x 3'-2"           | 3 x 2'-8"             | 1 x 6'-5" | 2 x 3'-2"             | 3 x 2'-8" |
| <b>Main Floor Walls of Two Story Structure Supporting 2nd Story Wood Framed Walls, Floor and Roof (TYPE C)</b> |   |                     |                       |           |                       |           |
|  | 6" & 8" Thick Wall                        |                     | 10" & 12" Thick Wall  |           | 6" & 8" Thick Wall    |           |
|  | Number and length of shear walls provided |                     |                       |           |                       |           |
| 2.44 (8)   | 1 x 6'-5"                                 | 2 x 3'-2"           | 3 x 2'-8"             | 1 x 6'-5" | 2 x 3'-2"             | 3 x 2'-8" |
| 2.75 (9)   | 1 x 6'-5"                                 | 2 x 3'-2"           | 3 x 2'-8"             | 1 x 6'-5" | 2 x 3'-2"             | 3 x 2'-8" |
| 3.05 (10)  | 1 x 6'-5"                                 | 2 x 3'-2"           | 3 x 2'-8"             | 1 x 6'-5" | 2 x 3'-2"             | 3 x 2'-8" |
| 3.66 (12)  | 1 x 6'-5"                                 | 2 x 3'-2"           | 3 x 2'-8"             | 1 x 6'-5" | 2 x 3'-2"             | 3 x 2'-8" |
| 4.27 (14)  | 1 x 6'-5"                                 | 2 x 3'-2"           | 3 x 2'-8"             | 1 x 6'-5" | 2 x 3'-2"             | 3 x 2'-8" |
| 4.88 (16)  | 1 x 6'-5"                                 | 2 x 3'-2"           | 3 x 2'-8"             | 1 x 6'-5" | 2 x 3'-2"             | 3 x 2'-8" |
| <b>Main Floor Walls of Two Story ICF Structure Supporting Wood Frame Floors and Roof (TYPE D)</b>              |   |                     |                       |           |                       |           |
|  | 6" & 8" Thick Wall                        |                     | 10" & 12" Thick Wall  |           | 6" & 8" Thick Wall    |           |
|  | Number and length of shear walls provided |                     |                       |           |                       |           |
| 2.44 (8)   | 1 x 7'-2"                                 | 2 x 4'-5"           | 3 x 3'-7"             | 1 x 8'-0" | 2 x 5'-7"             | 3 x 4'-0" |
| 2.75 (9)   | 1 x 7'-2"                                 | 2 x 4'-5"           | 3 x 3'-7"             | 1 x 8'-0" | 2 x 5'-7"             | 3 x 4'-0" |
| 3.05 (10)  | 1 x 7'-2"                                 | 2 x 4'-5"           | 3 x 3'-7"             | 1 x 8'-0" | 2 x 5'-7"             | 3 x 4'-0" |
| 3.66 (12)  | 1 x 8'-0"                                 | 2 x 5'-7"           | 3 x 4'-0"             | 1 x 8'-0" | 2 x 5'-7"             | 3 x 4'-0" |
| 4.27 (14)  | 1 x 8'-0"                                 | 2 x 5'-7"           | 3 x 4'-0"             | 1 x 8'-0" | 2 x 5'-7"             | 3 x 4'-0" |
| 4.88 (16)  | 1 x 8'-0"                                 | 2 x 5'-7"           | 3 x 4'-0"             | 1 x 8'-0" | 2 x 5'-7"             | 3 x 4'-0" |
| Vertical Reinforcement   | ICF with 6" Tie Spacing                   | As per table A.1.1. |                       |           | As per table A.1.1.   |           |
| Vertical Reinforcement   | ICF with 8" Tie Spacing                   | As per table A.1.2. |                       |           | As per table A.1.2.   |           |
| Horizontal Reinforcement   | Block Height of 12" and 18"               | 10 M @              | 450 (18)              | 10 M @    | 450 (18)              | 10 M @    |
| Horizontal Reinforcement   | Block Height of 16"                       | 10 M @              | 400 (16)              | 10 M @    | 400 (16)              | 10 M @    |

**NOTES:**

1.  $S_{a,ICF}$  is equivalent spectral response acceleration for ICF walls as provided in Appendix A.
2. This table is to be used in conjunction with the "Design Limitations."
3. Provide two layers of the indicated horizontal and vertical distributed steel specified for 300mm (12") walls. Place each layer as shown in the rebar placement drawing.
4. All four sides of the building are to have a minimum number and length of shear walls that conforms to this table.
5. Use Table A.6 for buildings that do not meet the required wall length of this table.
6. Provide 2-15M concentrated reinforcement at each end of shear walls as shown in shear wall detail.
7. All concentrated reinforcement is to be continued to the bottom of the foundation wall. Provide lap splices as required.
8. Concentrated reinforcement is to be placed in accordance with Bar Placement Detail.

**INSULATING CONCRETE FORMS MANUFACTURERS ASSOCIATION**



**Table A.4.1600. Above Grade Shear Wall Length for Seismic Zone Classification,  $S_{a,ICF} \leq 0.16$  and Hourly Wind Pressure,  $0.5kPa < q_{1/50} \leq 0.75kPa$  (in a Building Without Walkout Basement), where Building Area  $\leq 1600ft^2$**

| Wall Height m (ft)   | $S_{a,ICF} \leq 0.07$                     |            |                      | Seismic Zone Classification |                    |            | $S_{a,ICF} \leq 0.16$ |            |                    |                     |                      |            |             |            |            |             |            |            |
|--|---|------------|----------------------|-----------------------------|--------------------|------------|-----------------------|------------|--------------------|---------------------|----------------------|------------|-------------|------------|------------|-------------|------------|------------|
|  | $S_{a,ICF} \leq 0.07$                     |            |                      | $S_{a,ICF} \leq 0.11$       |                    |            | $S_{a,ICF} \leq 0.16$ |            |                    |                     |                      |            |             |            |            |             |            |            |
| <b>Second Floor Walls of Two Story ICF Structure Supporting Wood Frame Roof (TYPE A)</b>                       |   |            |                      |                             |                    |            |                       |            |                    |                     |                      |            |             |            |            |             |            |            |
|  | 6" & 8" Thick Wall                        |            | 10" & 12" Thick Wall |                             | 6" & 8" Thick Wall |            | 10" & 12" Thick Wall  |            | 6" & 8" Thick Wall |                     | 10" & 12" Thick Wall |            |             |            |            |             |            |            |
|  | Number and length of shear walls provided |            |                      |                             |                    |            |                       |            |                    |                     |                      |            |             |            |            |             |            |            |
| 2.44 (8)   | 1 x 6'-5"                                 | 2 x 3'-2"  | 3 x 2'-8"            | 1 x 6'-5"                   | 2 x 3'-2"          | 3 x 2'-8"  | 1 x 6'-5"             | 2 x 3'-2"  | 3 x 2'-8"          | 1 x 6'-5"           | 2 x 3'-2"            | 3 x 2'-8"  | 1 x 6'-5"   | 2 x 3'-2"  | 3 x 2'-8"  |             |            |            |
| 2.75 (9)   | 1 x 6'-5"                                 | 2 x 3'-2"  | 3 x 2'-8"            | 1 x 6'-5"                   | 2 x 3'-2"          | 3 x 2'-8"  | 1 x 6'-5"             | 2 x 3'-2"  | 3 x 2'-8"          | 1 x 6'-5"           | 2 x 3'-2"            | 3 x 2'-8"  | 1 x 6'-5"   | 2 x 3'-2"  | 3 x 2'-8"  |             |            |            |
| 3.05 (10)  | 1 x 6'-5"                                 | 2 x 3'-2"  | 3 x 2'-8"            | 1 x 6'-5"                   | 2 x 3'-2"          | 3 x 2'-8"  | 1 x 6'-5"             | 2 x 3'-2"  | 3 x 2'-8"          | 1 x 6'-5"           | 2 x 3'-2"            | 3 x 2'-8"  | 1 x 6'-5"   | 2 x 3'-2"  | 3 x 2'-8"  |             |            |            |
| <b>Main Floor Walls of One Story ICF Structure Supporting Wood Frame Roof (TYPE B)</b>                         |   |            |                      |                             |                    |            |                       |            |                    |                     |                      |            |             |            |            |             |            |            |
|  | 6" & 8" Thick Wall                        |            | 10" & 12" Thick Wall |                             | 6" & 8" Thick Wall |            | 10" & 12" Thick Wall  |            | 6" & 8" Thick Wall |                     | 10" & 12" Thick Wall |            |             |            |            |             |            |            |
|  | Number and length of shear walls provided |            |                      |                             |                    |            |                       |            |                    |                     |                      |            |             |            |            |             |            |            |
| 2.44 (8)   | 1 x 6'-5"                                 | 2 x 3'-2"  | 3 x 2'-8"            | 1 x 6'-5"                   | 2 x 3'-2"          | 3 x 2'-8"  | 1 x 6'-5"             | 2 x 3'-2"  | 3 x 2'-8"          | 1 x 6'-5"           | 2 x 3'-2"            | 3 x 2'-8"  | 1 x 6'-5"   | 2 x 3'-2"  | 3 x 2'-8"  |             |            |            |
| 2.75 (9)   | 1 x 6'-5"                                 | 2 x 3'-2"  | 3 x 2'-8"            | 1 x 6'-5"                   | 2 x 3'-2"          | 3 x 2'-8"  | 1 x 6'-5"             | 2 x 3'-2"  | 3 x 2'-8"          | 1 x 6'-5"           | 2 x 3'-2"            | 3 x 2'-8"  | 1 x 6'-5"   | 2 x 3'-2"  | 3 x 2'-8"  |             |            |            |
| 3.05 (10)  | 1 x 6'-5"                                 | 2 x 3'-2"  | 3 x 2'-8"            | 1 x 6'-5"                   | 2 x 3'-2"          | 3 x 2'-8"  | 1 x 6'-5"             | 2 x 3'-2"  | 3 x 2'-8"          | 1 x 6'-5"           | 2 x 3'-2"            | 3 x 2'-8"  | 1 x 6'-5"   | 2 x 3'-2"  | 3 x 2'-8"  |             |            |            |
| 3.66 (12)  | 1 x 6'-5"                                 | 2 x 3'-2"  | 3 x 2'-8"            | 1 x 6'-5"                   | 2 x 3'-2"          | 3 x 2'-8"  | 1 x 6'-5"             | 2 x 3'-2"  | 3 x 2'-8"          | 1 x 6'-5"           | 2 x 3'-2"            | 3 x 2'-8"  | 1 x 6'-5"   | 2 x 3'-2"  | 3 x 2'-8"  |             |            |            |
| 4.27 (14)  | 1 x 6'-5"                                 | 2 x 3'-2"  | 3 x 2'-8"            | 1 x 6'-5"                   | 2 x 3'-2"          | 3 x 2'-8"  | 1 x 6'-5"             | 2 x 3'-2"  | 3 x 2'-8"          | 1 x 6'-5"           | 2 x 3'-2"            | 3 x 2'-8"  | 1 x 6'-5"   | 2 x 3'-2"  | 3 x 2'-8"  |             |            |            |
| 4.88 (16)  | 1 x 6'-5"                                 | 2 x 3'-2"  | 3 x 2'-8"            | 1 x 6'-5"                   | 2 x 3'-2"          | 3 x 2'-8"  | 1 x 6'-5"             | 2 x 3'-2"  | 3 x 2'-8"          | 1 x 6'-5"           | 2 x 3'-2"            | 3 x 2'-8"  | 1 x 6'-5"   | 2 x 3'-2"  | 3 x 2'-8"  |             |            |            |
| <b>Main Floor Walls of Two Story Structure Supporting 2nd Story Wood Framed Walls, Floor and Roof (TYPE C)</b> |   |            |                      |                             |                    |            |                       |            |                    |                     |                      |            |             |            |            |             |            |            |
|  | 6" & 8" Thick Wall                        |            | 10" & 12" Thick Wall |                             | 6" & 8" Thick Wall |            | 10" & 12" Thick Wall  |            | 6" & 8" Thick Wall |                     | 10" & 12" Thick Wall |            |             |            |            |             |            |            |
|  | Number and length of shear walls provided |            |                      |                             |                    |            |                       |            |                    |                     |                      |            |             |            |            |             |            |            |
| 2.44 (8)   | 1 x 6'-5"                                 | 2 x 3'-2"  | 3 x 2'-10"           | 1 x 6'-5"                   | 2 x 3'-2"          | 3 x 2'-8"  | 1 x 7'-2"             | 2 x 4'-10" | 3 x 4'-0"          | 1 x 7'-2"           | 2 x 5'-2"            | 3 x 4'-0"  | 1 x 9'-2"   | 2 x 6'-0"  | 3 x 4'-10" | 1 x 9'-2"   | 2 x 5'-7"  | 3 x 4'-5"  |
| 2.75 (9)   | 1 x 6'-5"                                 | 2 x 3'-2"  | 3 x 2'-10"           | 1 x 6'-5"                   | 2 x 3'-2"          | 3 x 2'-10" | 1 x 7'-2"             | 2 x 5'-2"  | 3 x 4'-0"          | 1 x 8'-0"           | 2 x 5'-7"            | 3 x 4'-0"  | 1 x 9'-7"   | 2 x 6'-0"  | 3 x 4'-10" | 1 x 9'-7"   | 2 x 6'-0"  | 3 x 4'-10" |
| 3.05 (10)  | 1 x 6'-5"                                 | 2 x 4'-0"  | 3 x 3'-2"            | 1 x 6'-5"                   | 2 x 4'-0"          | 3 x 3'-2"  | 1 x 8'-0"             | 2 x 5'-10" | 3 x 4'-10"         | 1 x 8'-0"           | 2 x 5'-10"           | 3 x 4'-10" | 1 x 10'-0"  | 2 x 6'-10" | 3 x 5'-2"  | 1 x 10'-0"  | 2 x 6'-5"  | 3 x 5'-2"  |
| 3.66 (12)  | 1 x 6'-10"                                | 2 x 4'-5"  | 3 x 3'-2"            | 1 x 6'-10"                  | 2 x 4'-5"          | 3 x 3'-2"  | 1 x 8'-5"             | 2 x 6'-8"  | 3 x 5'-2"          | 1 x 8'-5"           | 2 x 6'-8"            | 3 x 5'-2"  | 1 x 10'-5"  | 2 x 7'-2"  | 3 x 5'-7"  | 1 x 10'-5"  | 2 x 7'-2"  | 3 x 5'-7"  |
| 4.27 (14)  | 1 x 6'-10"                                | 2 x 4'-5"  | 3 x 3'-7"            | 1 x 6'-10"                  | 2 x 4'-5"          | 3 x 3'-7"  | 1 x 8'-10"            | 2 x 6'-10" | 3 x 5'-7"          | 1 x 8'-10"          | 2 x 6'-10"           | 3 x 5'-7"  | 1 x 9'-2"   | 2 x 7'-2"  | 3 x 5'-7"  | 1 x 10'-5"  | 2 x 7'-2"  | 3 x 5'-7"  |
| 4.88 (16)  | 1 x 6'-10"                                | 2 x 4'-5"  | 3 x 3'-7"            | 1 x 6'-10"                  | 2 x 4'-5"          | 3 x 3'-7"  | 1 x 8'-10"            | 2 x 7'-2"  | 3 x 6'-0"          | 1 x 9'-7"           | 2 x 7'-7"            | 3 x 6'-0"  | 1 x 10'-5"  | 2 x 7'-2"  | 3 x 6'-0"  | 1 x 11'-7"  | 2 x 8'-0"  | 3 x 6'-0"  |
| <b>Main Floor Walls of Two Story ICF Structure Supporting Wood Frame Floors and Roof (TYPE D)</b>              |   |            |                      |                             |                    |            |                       |            |                    |                     |                      |            |             |            |            |             |            |            |
|  | 6" & 8" Thick Wall                        |            | 10" & 12" Thick Wall |                             | 6" & 8" Thick Wall |            | 10" & 12" Thick Wall  |            | 6" & 8" Thick Wall |                     | 10" & 12" Thick Wall |            |             |            |            |             |            |            |
|  | Number and length of shear walls provided |            |                      |                             |                    |            |                       |            |                    |                     |                      |            |             |            |            |             |            |            |
| 2.44 (8)   | 1 x 7'-2"                                 | 2 x 4'-5"  | 3 x 3'-7"            | 1 x 7'-2"                   | 2 x 4'-5"          | 3 x 3'-7"  | 1 x 8'-10"            | 2 x 5'-7"  | 3 x 4'-5"          | 1 x 9'-7"           | 2 x 6'-5"            | 3 x 4'-10" | 1 x 11'-2"  | 2 x 7'-2"  | 3 x 5'-7"  | 1 x 12'-10" | 2 x 8'-0"  | 3 x 6'-5"  |
| 2.75 (9)   | 1 x 7'-2"                                 | 2 x 4'-10" | 3 x 3'-7"            | 1 x 8'-0"                   | 2 x 4'-10"         | 3 x 4'-0"  | 1 x 9'-7"             | 2 x 6'-0"  | 3 x 4'-10"         | 1 x 10'-5"          | 2 x 6'-5"            | 3 x 4'-10" | 1 x 12'-0"  | 2 x 7'-7"  | 3 x 6'-5"  | 1 x 12'-10" | 2 x 8'-10" | 3 x 6'-5"  |
| 3.05 (10)  | 1 x 7'-7"                                 | 2 x 5'-2"  | 3 x 4'-0"            | 1 x 8'-0"                   | 2 x 5'-2"          | 3 x 4'-0"  | 1 x 10'-5"            | 2 x 6'-10" | 3 x 5'-2"          | 1 x 10'-5"          | 2 x 6'-10"           | 3 x 5'-2"  | 1 x 12'-5"  | 2 x 8'-5"  | 3 x 6'-5"  | 1 x 13'-7"  | 2 x 8'-10" | 3 x 6'-10" |
| 3.66 (12)  | 1 x 8'-0"                                 | 2 x 5'-7"  | 3 x 4'-0"            | 1 x 8'-5"                   | 2 x 5'-7"          | 3 x 4'-5"  | 1 x 10'-5"            | 2 x 7'-2"  | 3 x 5'-7"          | 1 x 10'-10"         | 2 x 7'-2"            | 3 x 5'-7"  | 1 x 12'-10" | 2 x 8'-10" | 3 x 7'-2"  | 1 x 13'-7"  | 2 x 8'-10" | 3 x 7'-2"  |
| 4.27 (14)  | 1 x 8'-0"                                 | 2 x 5'-7"  | 3 x 4'-5"            | 1 x 8'-10"                  | 2 x 6'-0"          | 3 x 4'-10" | 1 x 10'-5"            | 2 x 7'-2"  | 3 x 5'-7"          | 1 x 11'-7"          | 2 x 7'-7"            | 3 x 6'-5"  | 1 x 12'-10" | 2 x 8'-10" | 3 x 7'-2"  | 1 x 14'-5"  | 2 x 9'-7"  | 3 x 8'-0"  |
| 4.88 (16)  | 1 x 8'-0"                                 | 2 x 5'-7"  | 3 x 4'-5"            | 1 x 9'-2"                   | 2 x 6'-0"          | 3 x 4'-10" | 1 x 10'-5"            | 2 x 7'-2"  | 3 x 5'-7"          | 1 x 11'-7"          | 2 x 8'-0"            | 3 x 6'-5"  | 1 x 12'-10" | 2 x 8'-10" | 3 x 7'-2"  | 1 x 14'-5"  | 2 x 10'-0" | 3 x 8'-0"  |
| Vertical Reinforcement   | ICF with 6" Tie Spacing                   |            |                      | As per table A.1.1.         |                    |            | As per table A.1.1.   |            |                    | As per table A.1.1. |                      |            |             |            |            |             |            |            |
| Vertical Reinforcement   | ICF with 8" Tie Spacing                   |            |                      | As per table A.1.2.         |                    |            | As per table A.1.2.   |            |                    | As per table A.1.2. |                      |            |             |            |            |             |            |            |
| Horizontal Reinforcement   | Block Height of 12" and 18"               |            |                      | 10 M @ 450 (18)             |                    |            | 10 M @ 450 (18)       |            |                    | 10 M @ 450 (18)     |                      |            |             |            |            |             |            |            |
| Horizontal Reinforcement   | Block Height of 16"                       |            |                      | 10 M @ 400 (16)             |                    |            | 10 M @ 400 (16)       |            |                    | 10 M @ 400 (16)     |                      |            |             |            |            |             |            |            |

**NOTES:**

1.  $S_{a,ICF}$  is equivalent spectral response acceleration for ICF walls as provided in Appendix A.
2. This table is to be used in conjunction with the "Design Limitations."
3. Provide two layers of the indicated horizontal and vertical distributed steel specified for 300mm (12") walls. Place each layer as shown in the rebar placement drawing.
4. All four sides of the building are to have a minimum number and length of shear walls that conforms to this table.
5. Use Table A.6 for buildings that do not meet the required wall length of this table.
6. Provide 2-15M concentrated reinforcement at each end of shear walls as shown in shear wall detail.
7. All concentrated reinforcement is to be continues to the bottom of the foundation wall. Provide lap splices as required.
8. Concentrated reinforcement is to be placed in accordance with Bar Placement Detail.

INSULATING CONCRETE FORMS  
MANUFACTURERS ASSOCIATION



**Table A.5.1600. Above Grade Shear Wall Length for Seismic Zone Classification,  $S_{a,ICF} \leq 0.16$  and Hourly Wind Pressure,  $0.5kPa < q_{1/50} \leq 0.75kPa$  (in a Building Without Walkout Basement), where Building Area  $\leq 1600ft^2$**

| Wall Height m (ft)   | Seismic Zone Classification               |                     |                       |                     |                       |                     |
|--|---|---------------------|-----------------------|---------------------|-----------------------|---------------------|
|  | $S_{a,ICF} \leq 0.07$                     |                     | $S_{a,ICF} \leq 0.11$ |                     | $S_{a,ICF} \leq 0.16$ |                     |
| <b>Second Floor Walls of Two Story ICF Structure Supporting Wood Frame Roof (TYPE A)</b>                       |   |                     |                       |                     |                       |                     |
|  | 6" & 8" Thick Wall                        |                     | 10" & 12" Thick Wall  |                     | 6" & 8" Thick Wall    |                     |
|  | Number and length of shear walls provided |                     |                       |                     |                       |                     |
| 2.44 (8)   | 1 x 6'-5"                                 | 2 x 3'-2"           | 3 x 2'-8"             | 1 x 6'-5"           | 2 x 3'-2"             | 3 x 2'-8"           |
| 2.75 (9)   | 1 x 6'-5"                                 | 2 x 3'-2"           | 3 x 2'-8"             | 1 x 6'-5"           | 2 x 3'-2"             | 3 x 2'-8"           |
| 3.05 (10)  | 1 x 6'-5"                                 | 2 x 3'-2"           | 3 x 2'-8"             | 1 x 6'-5"           | 2 x 3'-2"             | 3 x 2'-8"           |
| <b>Main Floor Walls of One Story ICF Structure Supporting Wood Frame Roof (TYPE B)</b>                         |   |                     |                       |                     |                       |                     |
|  | 6" & 8" Thick Wall                        |                     | 10" & 12" Thick Wall  |                     | 6" & 8" Thick Wall    |                     |
|  | Number and length of shear walls provided |                     |                       |                     |                       |                     |
| 2.44 (8)   | 1 x 6'-5"                                 | 2 x 3'-2"           | 3 x 2'-8"             | 1 x 6'-5"           | 2 x 3'-2"             | 3 x 2'-8"           |
| 2.75 (9)   | 1 x 6'-5"                                 | 2 x 3'-2"           | 3 x 2'-8"             | 1 x 6'-5"           | 2 x 3'-2"             | 3 x 2'-8"           |
| 3.05 (10)  | 1 x 6'-5"                                 | 2 x 3'-2"           | 3 x 2'-8"             | 1 x 6'-5"           | 2 x 3'-2"             | 3 x 2'-8"           |
| 3.66 (12)  | 1 x 6'-5"                                 | 2 x 3'-2"           | 3 x 2'-8"             | 1 x 6'-5"           | 2 x 3'-2"             | 3 x 2'-8"           |
| 4.27 (14)  | 1 x 6'-5"                                 | 2 x 3'-2"           | 3 x 2'-8"             | 1 x 6'-5"           | 2 x 3'-2"             | 3 x 2'-8"           |
| 4.88 (16)  | 1 x 6'-5"                                 | 2 x 3'-2"           | 3 x 2'-8"             | 1 x 6'-5"           | 2 x 3'-2"             | 3 x 2'-8"           |
| <b>Main Floor Walls of Two Story Structure Supporting 2nd Story Wood Framed Walls, Floor and Roof (TYPE C)</b> |   |                     |                       |                     |                       |                     |
|  | 6" & 8" Thick Wall                        |                     | 10" & 12" Thick Wall  |                     | 6" & 8" Thick Wall    |                     |
|  | Number and length of shear walls provided |                     |                       |                     |                       |                     |
| 2.44 (8)   | 1 x 6'-5"                                 | 2 x 3'-9"           | 3 x 3'-0"             | 1 x 6'-5"           | 2 x 3'-2"             | 3 x 3'-0"           |
| 2.75 (9)   | 1 x 6'-5"                                 | 2 x 4'-0"           | 3 x 3'-0"             | 1 x 6'-5"           | 2 x 4'-3"             | 3 x 3'-0"           |
| 3.05 (10)  | 1 x 6'-5"                                 | 2 x 4'-3"           | 3 x 3'-2"             | 1 x 6'-5"           | 2 x 4'-0"             | 3 x 3'-2"           |
| 3.66 (12)  | 1 x 6'-10"                                | 2 x 4'-5"           | 3 x 3'-2"             | 1 x 6'-10"          | 2 x 4'-5"             | 3 x 3'-2"           |
| 4.27 (14)  | 1 x 6'-10"                                | 2 x 4'-5"           | 3 x 3'-7"             | 1 x 6'-10"          | 2 x 4'-5"             | 3 x 3'-7"           |
| 4.88 (16)  | 1 x 6'-10"                                | 2 x 4'-5"           | 3 x 3'-7"             | 1 x 6'-10"          | 2 x 4'-5"             | 3 x 3'-7"           |
| <b>Main Floor Walls of Two Story ICF Structure Supporting Wood Frame Floors and Roof (TYPE D)</b>              |   |                     |                       |                     |                       |                     |
|  | 6" & 8" Thick Wall                        |                     | 10" & 12" Thick Wall  |                     | 6" & 8" Thick Wall    |                     |
|  | Number and length of shear walls provided |                     |                       |                     |                       |                     |
| 2.44 (8)   | 1 x 7'-2"                                 | 2 x 4'-5"           | 3 x 3'-7"             | 1 x 7'-2"           | 2 x 4'-5"             | 3 x 3'-7"           |
| 2.75 (9)   | 1 x 7'-2"                                 | 2 x 4'-10"          | 3 x 3'-7"             | 1 x 7'-2"           | 2 x 5'-2"             | 3 x 4'-0"           |
| 3.05 (10)  | 1 x 7'-7"                                 | 2 x 5'-2"           | 3 x 4'-0"             | 1 x 7'-7"           | 2 x 5'-2"             | 3 x 4'-0"           |
| 3.66 (12)  | 1 x 8'-0"                                 | 2 x 5'-7"           | 3 x 4'-0"             | 1 x 8'-0"           | 2 x 5'-7"             | 3 x 4'-0"           |
| 4.27 (14)  | 1 x 8'-0"                                 | 2 x 5'-7"           | 3 x 4'-0"             | 1 x 8'-0"           | 2 x 5'-7"             | 3 x 4'-0"           |
| 4.88 (16)  | 1 x 8'-0"                                 | 2 x 5'-7"           | 3 x 4'-5"             | 1 x 8'-0"           | 2 x 5'-7"             | 3 x 4'-5"           |
| Vertical Reinforcement   | ICF with 6" Tie Spacing                   | As per table A.1.1. |                       | As per table A.1.1. |                       | As per table A.1.1. |
| Vertical Reinforcement   | ICF with 8" Tie Spacing                   | As per table A.1.2. |                       | As per table A.1.2. |                       | As per table A.1.2. |
| Horizontal Reinforcement   | Block Height of 12" and 18"               | 10 M @ 450 (18)     |                       | 10 M @ 450 (18)     |                       | 10 M @ 450 (18)     |
| Horizontal Reinforcement   | Block Height of 16"                       | 10 M @ 400 (16)     |                       | 10 M @ 400 (16)     |                       | 10 M @ 400 (16)     |

**NOTES:**

1.  $S_{a,ICF}$  is equivalent spectral response acceleration for ICF walls as provided in Appendix A.
2. This table is to be used in conjunction with the "Design Limitations."
3. Provide two layers of the indicated horizontal and vertical distributed steel specified for 300mm (12") walls. Place each layer as shown in the rebar placement drawing.
4. All four sides of the building are to have a minimum number and length of shear walls that conforms to this table.
5. Use Table A.6 for buildings that do not meet the required wall length of this table.
6. Provide 2-15M concentrated reinforcement at each end of shear walls as shown in shear wall detail.
7. All concentrated reinforcement is to be continues to the bottom of the foundation wall. Provide lap splices as required.
8. Concentrated reinforcement is to be placed in accordance with Bar Placement Detail.

**INSULATING CONCRETE FORMS MANUFACTURERS ASSOCIATION**



**Table A.6.1600. Above Grade Shear Wall Length for Seismic Zone Classification,  $S_{a,ICF} > 0.16$  and Hourly Wind Pressure,  $q_{1/50} \leq 1.05\text{kPa}$  (in a Building Without Walkout Basement), where Building Area  $\leq 1600\text{ft}^2$**

| Wall Height m (ft)   | Seismic Zone Classification               |           |                      |                       |                     |           |                       |            |                     |                       |                      |           |
|--|---|-----------|----------------------|-----------------------|---------------------|-----------|-----------------------|------------|---------------------|-----------------------|----------------------|-----------|
|  | $S_{a,ICF} \leq 0.16$                     |           |                      | $S_{a,ICF} \leq 0.31$ |                     |           | $S_{a,ICF} \leq 0.53$ |            |                     | $S_{a,ICF} \leq 0.79$ |                      |           |
| <b>Second Floor Walls of Two Story ICF Structure Supporting Wood Frame Roof (TYPE A)</b>                       |   |           |                      |                       |                     |           |                       |            |                     |                       |                      |           |
|  | 6" & 8" Thick Wall                        |           | 10" & 12" Thick Wall |                       | 6" & 8" Thick Wall  |           | 10" & 12" Thick Wall  |            | 6" & 8" Thick Wall  |                       | 10" & 12" Thick Wall |           |
|  | Number and length of shear walls provided |           |                      |                       |                     |           |                       |            |                     |                       |                      |           |
| 2.44 (8)   | 1x 6'-5"                                  | 2x 3'-2"  | 3x 2'-8"             | 1x 6'-5"              | 2x 3'-2"            | 3x 2'-8"  | 1x 7'-2"              | 2x 4'-10"  | 3x 4'-0"            | 1x 7'-2"              | 2x 4'-10"            | 3x 4'-0"  |
| 2.75 (9)   | 1x 6'-5"                                  | 2x 3'-2"  | 3x 2'-10"            | 1x 6'-5"              | 2x 3'-2"            | 3x 2'-10" | 1x 8'-0"              | 2x 5'-7"   | 3x 4'-6"            | 1x 8'-0"              | 2x 5'-7"             | 3x 4'-6"  |
| 3.05 (10)  | 1x 6'-5"                                  | 2x 4'-0"  | 3x 3'-2"             | 1x 6'-5"              | 2x 4'-0"            | 3x 3'-2"  | 1x 8'-0"              | 2x 5'-7"   | 3x 5'-0"            | 1x 8'-0"              | 2x 5'-7"             | 3x 5'-0"  |
| 3.66 (12)  | 1x 6'-5"                                  | 2x 4'-3"  | 3x 3'-6"             | 1x 7'-7"              | 2x 5'-1"            | 3x 4'-0"  | 1x 8'-10"             | 2x 6'-0"   | 3x 5'-0"            | 1x 10'-0"             | 2x 6'-10"            | 3x 5'-7"  |
| 4.27 (14)  | 1x 7'-2"                                  | 2x 5'-1"  | 3x 4'-0"             | 1x 7'-7"              | 2x 5'-2"            | 3x 4'-0"  | 1x 10'-5"             | 2x 7'-2"   | 3x 7'-0"            | 1x 10'-5"             | 2x 7'-2"             | 3x 7'-0"  |
| 4.88 (16)  | 1x 7'-7"                                  | 2x 5'-2"  | 3x 4'-4"             | 1x 8'-6"              | 2x 5'-10"           | 3x 4'-6"  | 1x 10'-10"            | 2x 8'-0"   | 3x 7'-0"            | 1x 12'-4"             | 2x 8'-5"             | 3x 8'-0"  |
| <b>Main Floor Walls of One Story ICF Structure Supporting Wood Frame Roof (TYPE B)</b>                         |   |           |                      |                       |                     |           |                       |            |                     |                       |                      |           |
|  | 6" & 8" Thick Wall                        |           | 10" & 12" Thick Wall |                       | 6" & 8" Thick Wall  |           | 10" & 12" Thick Wall  |            | 6" & 8" Thick Wall  |                       | 10" & 12" Thick Wall |           |
|  | Number and length of shear walls provided |           |                      |                       |                     |           |                       |            |                     |                       |                      |           |
| 2.44 (8)   | 1x 6'-5"                                  | 2x 3'-2"  | 3x 2'-8"             | 1x 6'-5"              | 2x 3'-2"            | 3x 2'-8"  | 1x 7'-2"              | 2x 4'-0"   | 3x 4'-0"            | 1x 7'-2"              | 2x 4'-0"             | 3x 4'-0"  |
| 2.75 (9)   | 1x 6'-5"                                  | 2x 3'-2"  | 3x 2'-8"             | 1x 6'-5"              | 2x 3'-2"            | 3x 2'-8"  | 1x 7'-2"              | 2x 4'-10"  | 3x 4'-6"            | 1x 8'-0"              | 2x 5'-7"             | 3x 4'-6"  |
| 3.05 (10)  | 1x 6'-5"                                  | 2x 3'-7"  | 3x 2'-10"            | 1x 6'-5"              | 2x 4'-0"            | 3x 2'-10" | 1x 8'-0"              | 2x 5'-7"   | 3x 5'-0"            | 1x 10'-0"             | 2x 6'-10"            | 3x 5'-7"  |
| 3.66 (12)  | 1x 6'-5"                                  | 2x 4'-3"  | 3x 3'-6"             | 1x 7'-7"              | 2x 5'-1"            | 3x 4'-0"  | 1x 8'-10"             | 2x 6'-0"   | 3x 5'-0"            | 1x 10'-0"             | 2x 6'-10"            | 3x 5'-7"  |
| 4.27 (14)  | 1x 7'-2"                                  | 2x 5'-1"  | 3x 4'-0"             | 1x 7'-7"              | 2x 5'-2"            | 3x 4'-0"  | 1x 10'-5"             | 2x 7'-2"   | 3x 7'-0"            | 1x 10'-5"             | 2x 7'-2"             | 3x 7'-0"  |
| 4.88 (16)  | 1x 7'-7"                                  | 2x 5'-2"  | 3x 4'-4"             | 1x 8'-6"              | 2x 5'-10"           | 3x 4'-6"  | 1x 10'-10"            | 2x 8'-0"   | 3x 7'-0"            | 1x 12'-4"             | 2x 8'-5"             | 3x 8'-0"  |
| <b>Main Floor Walls of Two Story Structure Supporting 2nd Story Wood Framed Walls, Floor and Roof (TYPE C)</b> |   |           |                      |                       |                     |           |                       |            |                     |                       |                      |           |
|  | 6" & 8" Thick Wall                        |           | 10" & 12" Thick Wall |                       | 6" & 8" Thick Wall  |           | 10" & 12" Thick Wall  |            | 6" & 8" Thick Wall  |                       | 10" & 12" Thick Wall |           |
|  | Number and length of shear walls provided |           |                      |                       |                     |           |                       |            |                     |                       |                      |           |
| 2.44 (8)   | 1x 8'-0"                                  | 2x 5'-2"  | 3x 4'-0"             | 1x 8'-0"              | 2x 5'-2"            | 3x 4'-0"  | 1x 11'-2"             | 2x 7'-7"   | 3x 6'-0"            | 1x 11'-2"             | 2x 7'-7"             | 3x 6'-0"  |
| 2.75 (9)   | 1x 8'-0"                                  | 2x 5'-7"  | 3x 4'-10"            | 1x 8'-10"             | 2x 5'-7"            | 3x 4'-10" | 1x 12'-0"             | 2x 8'-0"   | 3x 6'-5"            | 1x 12'-0"             | 2x 8'-0"             | 3x 6'-5"  |
| 3.05 (10)  | 1x 8'-10"                                 | 2x 6'-0"  | 3x 4'-10"            | 1x 8'-10"             | 2x 6'-0"            | 3x 4'-10" | 1x 12'-0"             | 2x 8'-10"  | 3x 6'-10"           | 1x 13'-7"             | 2x 8'-10"            | 3x 6'-10" |
| 3.66 (12)  | 1x 9'-2"                                  | 2x 6'-5"  | 3x 5'-2"             | 1x 10'-5"             | 2x 7'-2"            | 3x 5'-7"  | 1x 12'-10"            | 2x 9'-2"   | 3x 7'-2"            | 1x 14'-10"            | 2x 10'-0"            | 3x 8'-0"  |
| 4.27 (14)  | 1x 10'-0"                                 | 2x 6'-10" | 3x 5'-7"             | 1x 10'-5"             | 2x 7'-2"            | 3x 5'-7"  | 1x 14'-0"             | 2x 9'-7"   | 3x 8'-0"            | 1x 14'-10"            | 2x 10'-0"            | 3x 8'-0"  |
| 4.88 (16)  | 1x 10'-0"                                 | 2x 6'-10" | 3x 5'-7"             | 1x 10'-5"             | 2x 7'-2"            | 3x 5'-7"  | 1x 14'-0"             | 2x 9'-7"   | 3x 8'-0"            | 1x 15'-2"             | 2x 10'-0"            | 3x 8'-0"  |
| <b>Main Floor Walls of Two Story ICF Structure Supporting Wood Frame Floors and Roof (TYPE D)</b>              |   |           |                      |                       |                     |           |                       |            |                     |                       |                      |           |
|  | 6" & 8" Thick Wall                        |           | 10" & 12" Thick Wall |                       | 6" & 8" Thick Wall  |           | 10" & 12" Thick Wall  |            | 6" & 8" Thick Wall  |                       | 10" & 12" Thick Wall |           |
|  | Number and length of shear walls provided |           |                      |                       |                     |           |                       |            |                     |                       |                      |           |
| 2.44 (8)   | 1x 9'-7"                                  | 2x 6'-5"  | 3x 5'-2"             | 1x 10'-0"             | 2x 6'-10"           | 3x 5'-2"  | 1x 13'-7"             | 2x 9'-7"   | 3x 7'-2"            | 1x 14'-5"             | 2x 9'-7"             | 3x 7'-2"  |
| 2.75 (9)   | 1x 10'-5"                                 | 2x 7'-2"  | 3x 5'-7"             | 1x 10'-5"             | 2x 7'-2"            | 3x 5'-7"  | 1x 14'-5"             | 2x 10'-5"  | 3x 8'-0"            | 1x 16'-0"             | 2x 10'-5"            | 3x 8'-0"  |
| 3.05 (10)  | 1x 11'-2"                                 | 2x 7'-2"  | 3x 5'-7"             | 1x 11'-2"             | 2x 8'-0"            | 3x 6'-0"  | 1x 15'-2"             | 2x 10'-5"  | 3x 8'-10"           | 1x 16'-0"             | 2x 11'-2"            | 3x 10'-5" |
| 3.66 (12)  | 1x 11'-2"                                 | 2x 7'-7"  | 3x 6'-0"             | 1x 12'-10"            | 2x 8'-10"           | 3x 7'-0"  | 1x 16'-0"             | 2x 10'-6"  | 3x 8'-10"           | 1x 20'-4"             | 2x 14'-5"            | 3x 11'-4" |
| 4.27 (14)  | 1x 12'-0"                                 | 2x 8'-4"  | 3x 6'-5"             | 1x 12'-10"            | 2x 8'-10"           | 3x 7'-0"  | 1x 18'-5"             | 2x 12'-10" | 3x 10'-0"           | 1x 22'-5"             | 2x 15'-6"            | 3x 12'-5" |
| 4.88 (16)  | 1x 12'-0"                                 | 2x 8'-4"  | 3x 6'-5"             | 1x 13'-7"             | 2x 9'-0"            | 3x 7'-2"  | 1x 16'-10"            | 2x 12'-0"  | 3x 9'-7"            | 1x 18'-8"             | 2x 12'-10"           | 3x 10'-4" |
| Vertical ICF with 6" The Spacing   | As per table A.2.1.                       |           | As per table A.2.1.  |                       | As per table A.2.1. |           | As per table A.2.1.   |            | As per table A.2.1. |                       | As per table A.2.1.  |           |
| Vertical ICF with 8" The Spacing   | As per table A.2.2.                       |           | As per table A.2.2.  |                       | As per table A.2.2. |           | As per table A.2.2.   |            | As per table A.2.2. |                       | As per table A.2.2.  |           |
| Horizontal Reinforcement Block Height of 12" and 18"   | As per table A.2.1.                       |           | As per table A.2.1.  |                       | As per table A.2.1. |           | As per table A.2.1.   |            | As per table A.2.1. |                       | As per table A.2.1.  |           |
| Horizontal Reinforcement Block Height of 16"   | As per table A.2.2.                       |           | As per table A.2.2.  |                       | As per table A.2.2. |           | As per table A.2.2.   |            | As per table A.2.2. |                       | As per table A.2.2.  |           |

**NOTES:**

- $S_{a,ICF}$  is equivalent spectral response acceleration for ICF walls as provided in Appendix A.
- This table is to be used in conjunction with the "Design Limitations."
- Provide two layers of the indicated horizontal and vertical distributed steel specified for 300mm (12") walls. Place each layer as shown in the rebar placement drawing.
- All four sides of the building are to have a minimum number and length of shear walls that conforms to this table.
- Provide 2-15M concentrated reinforcement at each end of shear walls as shown in shear wall detail.
- All concentrated reinforcement is to be continues to the bottom of the foundation wall. Provide lap splices as required.
- Concentrated reinforcement is to be placed in accordance with Bar Placement Detail.
- Horizontal reinforcement in shear walls where  $S_{a,ICF} > 0.16$  must be anchored using a standard 180° hook around vertical end bars.
- When using this table for  $S_{a,ICF} \leq 0.16$ , use the vertical and horizontal distributed steel in Tables A.2.1. or A.2.2.

INSULATING CONCRETE FORMS MANUFACTURERS ASSOCIATION



**Table A.7.1600. Above Grade Shear Wall Length for Seismic Zone Classification,  $S_{a,ICF} \leq 0.16$  and Hourly Wind Pressure,  $q_{1/50} \leq 0.5kPa$  (in a Building With Walk Basement), where Building Area  $\leq 1600ft^2$**

| Wall Height m (ft)   | Seismic Zone Classification               |                     |                       |            |                       |                     |                      |            |            |                     |            |            |             |            |            |             |             |            |
|--|---|---------------------|-----------------------|------------|-----------------------|---------------------|----------------------|------------|------------|---------------------|------------|------------|-------------|------------|------------|-------------|-------------|------------|
|  | $S_{a,ICF} \leq 0.07$                     |                     | $S_{a,ICF} \leq 0.11$ |            | $S_{a,ICF} \leq 0.16$ |                     |                      |            |            |                     |            |            |             |            |            |             |             |            |
| <b>Second Floor Walls of Two Story ICF Structure Supporting Wood Frame Roof (TYPE E)</b>                       |   |                     |                       |            |                       |                     |                      |            |            |                     |            |            |             |            |            |             |             |            |
|  | 6" & 8" Thick Wall                        |                     | 10" & 12" Thick Wall  |            | 6" & 8" Thick Wall    |                     | 10" & 12" Thick Wall |            |            |                     |            |            |             |            |            |             |             |            |
|  | Number and length of shear walls provided |                     |                       |            |                       |                     |                      |            |            |                     |            |            |             |            |            |             |             |            |
| 2.44 (8)   | 1 x 6'-5"                                 | 2 x 3'-2"           | 3 x 2'-8"             | 1 x 6'-5"  | 2 x 3'-2"             | 3 x 2'-8"           | 1 x 6'-5"            | 2 x 3'-2"  | 3 x 2'-8"  | 1 x 6'-5"           | 2 x 3'-7"  | 3 x 3'-2"  | 1 x 6'-5"   | 2 x 4'-0"  | 3 x 3'-2"  |             |             |            |
| 2.75 (9)   | 1 x 6'-5"                                 | 2 x 3'-2"           | 3 x 2'-8"             | 1 x 6'-5"  | 2 x 3'-2"             | 3 x 2'-8"           | 1 x 6'-5"            | 2 x 3'-2"  | 3 x 2'-8"  | 1 x 6'-5"           | 2 x 3'-6"  | 3 x 2'-8"  | 1 x 6'-10"  | 2 x 4'-3"  | 3 x 3'-6"  | 1 x 7'-6"   | 2 x 4'-5"   | 3 x 3'-6"  |
| 3.05 (10)  | 1 x 6'-5"                                 | 2 x 3'-2"           | 3 x 2'-8"             | 1 x 6'-5"  | 2 x 3'-2"             | 3 x 2'-8"           | 1 x 6'-5"            | 2 x 3'-7"  | 3 x 2'-10" | 1 x 6'-5"           | 2 x 3'-7"  | 3 x 2'-10" | 1 x 6'-10"  | 2 x 4'-5"  | 3 x 3'-6"  | 1 x 7'-7"   | 2 x 4'-6"   | 3 x 3'-6"  |
| 3.66 (12)  | 1 x 6'-5"                                 | 2 x 3'-2"           | 3 x 2'-8"             | 1 x 6'-5"  | 2 x 3'-2"             | 3 x 2'-8"           | 1 x 6'-10"           | 2 x 4'-5"  | 3 x 3'-6"  | 1 x 6'-10"          | 2 x 4'-5"  | 3 x 3'-6"  | 1 x 8'-5"   | 2 x 5'-7"  | 3 x 4'-5"  | 1 x 8'-10"  | 2 x 5'-7"   | 3 x 4'-5"  |
| 4.27 (14)  | 1 x 6'-5"                                 | 2 x 3'-7"           | 3 x 3'-2"             | 1 x 6'-5"  | 2 x 4'-0"             | 3 x 3'-2"           | 1 x 8'-0"            | 2 x 4'-10" | 3 x 3'-9"  | 1 x 8'-5"           | 2 x 5'-7"  | 3 x 4'-3"  | 1 x 9'-2"   | 2 x 6'-0"  | 3 x 4'-10" | 1 x 10'-0"  | 2 x 6'-8"   | 3 x 5'-2"  |
| 4.88 (16)  | 1 x 6'-5"                                 | 2 x 4'-0"           | 3 x 3'-2"             | 1 x 7'-2"  | 2 x 4'-5"             | 3 x 3'-7"           | 1 x 8'-0"            | 2 x 5'-2"  | 3 x 4'-0"  | 1 x 8'-10"          | 2 x 6'-0"  | 3 x 4'-6"  | 1 x 9'-7"   | 2 x 6'-5"  | 3 x 5'-2"  | 1 x 11'-2"  | 2 x 7'-6"   | 3 x 5'-10" |
| <b>Main Floor Walls of One Story ICF Structure Supporting Wood Frame Roof (TYPE F)</b>                         |   |                     |                       |            |                       |                     |                      |            |            |                     |            |            |             |            |            |             |             |            |
|  | 6" & 8" Thick Wall                        |                     | 10" & 12" Thick Wall  |            | 6" & 8" Thick Wall    |                     | 10" & 12" Thick Wall |            |            |                     |            |            |             |            |            |             |             |            |
|  | Number and length of shear walls provided |                     |                       |            |                       |                     |                      |            |            |                     |            |            |             |            |            |             |             |            |
| 2.44 (8)   | 1 x 6'-5"                                 | 2 x 3'-2"           | 3 x 2'-8"             | 1 x 6'-5"  | 2 x 3'-2"             | 3 x 2'-8"           | 1 x 6'-5"            | 2 x 3'-2"  | 3 x 2'-8"  | 1 x 6'-5"           | 2 x 3'-2"  | 3 x 2'-8"  | 1 x 6'-5"   | 2 x 3'-7"  | 3 x 2'-8"  | 1 x 6'-5"   | 2 x 3'-7"   | 3 x 2'-8"  |
| 2.75 (9)   | 1 x 6'-5"                                 | 2 x 3'-2"           | 3 x 2'-8"             | 1 x 6'-5"  | 2 x 3'-2"             | 3 x 2'-8"           | 1 x 6'-5"            | 2 x 3'-2"  | 3 x 2'-8"  | 1 x 6'-5"           | 2 x 3'-2"  | 3 x 2'-8"  | 1 x 6'-5"   | 2 x 3'-7"  | 3 x 2'-10" | 1 x 6'-10"  | 2 x 4'-0"   | 3 x 2'-11" |
| 3.05 (10)  | 1 x 6'-5"                                 | 2 x 3'-2"           | 3 x 2'-8"             | 1 x 6'-5"  | 2 x 3'-2"             | 3 x 2'-8"           | 1 x 6'-5"            | 2 x 3'-7"  | 3 x 2'-10" | 1 x 6'-5"           | 2 x 3'-7"  | 3 x 2'-10" | 1 x 6'-10"  | 2 x 4'-5"  | 3 x 3'-6"  | 1 x 7'-7"   | 2 x 4'-6"   | 3 x 3'-6"  |
| 3.66 (12)  | 1 x 6'-5"                                 | 2 x 3'-2"           | 3 x 2'-8"             | 1 x 6'-5"  | 2 x 3'-2"             | 3 x 2'-8"           | 1 x 6'-10"           | 2 x 4'-5"  | 3 x 3'-6"  | 1 x 6'-10"          | 2 x 4'-5"  | 3 x 3'-6"  | 1 x 8'-5"   | 2 x 5'-7"  | 3 x 4'-5"  | 1 x 8'-10"  | 2 x 5'-7"   | 3 x 4'-5"  |
| 4.27 (14)  | 1 x 6'-5"                                 | 2 x 3'-7"           | 3 x 3'-2"             | 1 x 6'-5"  | 2 x 4'-0"             | 3 x 3'-2"           | 1 x 8'-0"            | 2 x 4'-10" | 3 x 3'-9"  | 1 x 8'-5"           | 2 x 5'-7"  | 3 x 4'-3"  | 1 x 9'-2"   | 2 x 6'-0"  | 3 x 4'-10" | 1 x 10'-0"  | 2 x 6'-8"   | 3 x 5'-2"  |
| 4.88 (16)  | 1 x 6'-5"                                 | 2 x 4'-0"           | 3 x 3'-2"             | 1 x 7'-2"  | 2 x 4'-5"             | 3 x 3'-7"           | 1 x 8'-0"            | 2 x 5'-2"  | 3 x 4'-0"  | 1 x 8'-10"          | 2 x 6'-0"  | 3 x 4'-6"  | 1 x 9'-7"   | 2 x 6'-5"  | 3 x 5'-2"  | 1 x 11'-2"  | 2 x 7'-6"   | 3 x 5'-10" |
| <b>Main Floor Walls of Two Story Structure Supporting 2nd Story Wood Framed Walls, Floor and Roof (TYPE G)</b> |   |                     |                       |            |                       |                     |                      |            |            |                     |            |            |             |            |            |             |             |            |
|  | 6" & 8" Thick Wall                        |                     | 10" & 12" Thick Wall  |            | 6" & 8" Thick Wall    |                     | 10" & 12" Thick Wall |            |            |                     |            |            |             |            |            |             |             |            |
|  | Number and length of shear walls provided |                     |                       |            |                       |                     |                      |            |            |                     |            |            |             |            |            |             |             |            |
| 2.44 (8)   | 1 x 6'-5"                                 | 2 x 4'-0"           | 3 x 3'-2"             | 1 x 6'-5"  | 2 x 4'-0"             | 3 x 3'-2"           | 1 x 8'-0"            | 2 x 4'-10" | 3 x 4'-0"  | 1 x 8'-0"           | 2 x 5'-2"  | 3 x 4'-0"  | 1 x 10'-0"  | 2 x 6'-5"  | 3 x 4'-10" | 1 x 10'-5"  | 2 x 6'-5"   | 3 x 5'-2"  |
| 2.75 (9)   | 1 x 6'-5"                                 | 2 x 4'-0"           | 3 x 3'-2"             | 1 x 6'-5"  | 2 x 4'-0"             | 3 x 3'-2"           | 1 x 8'-5"            | 2 x 5'-2"  | 3 x 4'-0"  | 1 x 8'-10"          | 2 x 5'-7"  | 3 x 4'-0"  | 1 x 10'-10" | 2 x 6'-10" | 3 x 5'-2"  | 1 x 10'-11" | 2 x 7'-2"   | 3 x 5'-7"  |
| 3.05 (10)  | 1 x 6'-10"                                | 2 x 4'-5"           | 3 x 3'-6"             | 1 x 6'-10" | 2 x 4'-5"             | 3 x 3'-6"           | 1 x 9'-2"            | 2 x 5'-10" | 3 x 4'-10" | 1 x 9'-2"           | 2 x 5'-10" | 3 x 4'-10" | 1 x 11'-2"  | 2 x 7'-6"  | 3 x 5'-10" | 1 x 11'-7"  | 2 x 7'-6"   | 3 x 5'-10" |
| 3.66 (12)  | 1 x 7'-6"                                 | 2 x 5'-1"           | 3 x 4'-0"             | 1 x 7'-6"  | 2 x 5'-1"             | 3 x 4'-0"           | 1 x 9'-10"           | 2 x 6'-8"  | 3 x 5'-2"  | 1 x 9'-10"          | 2 x 6'-8"  | 3 x 5'-2"  | 1 x 12'-0"  | 2 x 8'-3"  | 3 x 6'-5"  | 1 x 12'-0"  | 2 x 8'-3"   | 3 x 6'-5"  |
| 4.27 (14)  | 1 x 7'-9"                                 | 2 x 5'-2"           | 3 x 4'-3"             | 1 x 8'-3"  | 2 x 5'-7"             | 3 x 4'-3"           | 1 x 10'-2"           | 2 x 6'-10" | 3 x 5'-7"  | 1 x 10'-10"         | 2 x 7'-2"  | 3 x 5'-7"  | 1 x 12'-5"  | 2 x 8'-5"  | 3 x 6'-10" | 1 x 13'-1"  | 2 x 9'-1"   | 3 x 7'-2"  |
| 4.88 (16)  | 1 x 8'-0"                                 | 2 x 5'-7"           | 3 x 4'-5"             | 1 x 8'-10" | 2 x 5'-10"            | 3 x 4'-6"           | 1 x 10'-5"           | 2 x 7'-2"  | 3 x 6'-0"  | 1 x 11'-2"          | 2 x 7'-7"  | 3 x 6'-0"  | 1 x 12'-5"  | 2 x 8'-5"  | 3 x 6'-10" | 1 x 13'-7"  | 2 x 9'-2"   | 3 x 7'-6"  |
| <b>Main Floor Walls of Two Story ICF Structure Supporting Wood Frame Floors and Roof (TYPE H)</b>              |   |                     |                       |            |                       |                     |                      |            |            |                     |            |            |             |            |            |             |             |            |
|  | 6" & 8" Thick Wall                        |                     | 10" & 12" Thick Wall  |            | 6" & 8" Thick Wall    |                     | 10" & 12" Thick Wall |            |            |                     |            |            |             |            |            |             |             |            |
|  | Number and length of shear walls provided |                     |                       |            |                       |                     |                      |            |            |                     |            |            |             |            |            |             |             |            |
| 2.44 (8)   | 1 x 7'-6"                                 | 2 x 4'-10"          | 3 x 3'-7"             | 1 x 8'-0"  | 2 x 5'-1"             | 3 x 4'-0"           | 1 x 10'-0"           | 2 x 6'-5"  | 3 x 4'-10" | 1 x 10'-8"          | 2 x 6'-10" | 3 x 5'-2"  | 1 x 12'-10" | 2 x 8'-0"  | 3 x 6'-5"  | 1 x 13'-2"  | 2 x 8'-10"  | 3 x 6'-10" |
| 2.75 (9)   | 1 x 7'-9"                                 | 2 x 5'-2"           | 3 x 3'-9"             | 1 x 8'-10" | 2 x 5'-2"             | 3 x 4'-0"           | 1 x 10'-5"           | 2 x 6'-8"  | 3 x 5'-2"  | 1 x 11'-2"          | 2 x 7'-2"  | 3 x 5'-7"  | 1 x 13'-2"  | 2 x 8'-10" | 3 x 6'-10" | 1 x 14'-0"  | 2 x 9'-2"   | 3 x 7'-2"  |
| 3.05 (10)  | 1 x 8'-3"                                 | 2 x 5'-2"           | 3 x 4'-0"             | 1 x 8'-10" | 2 x 5'-7"             | 3 x 4'-5"           | 1 x 10'-11"          | 2 x 7'-2"  | 3 x 5'-7"  | 1 x 12'-0"          | 2 x 7'-7"  | 3 x 6'-0"  | 1 x 14'-0"  | 2 x 9'-2"  | 3 x 7'-2"  | 1 x 14'-10" | 2 x 9'-7"   | 3 x 7'-9"  |
| 3.66 (12)  | 1 x 9'-2"                                 | 2 x 6'-0"           | 3 x 4'-10"            | 1 x 9'-2"  | 2 x 6'-0"             | 3 x 4'-10"          | 1 x 11'-7"           | 2 x 8'-0"  | 3 x 6'-2"  | 1 x 12'-0"          | 2 x 8'-0"  | 3 x 6'-2"  | 1 x 14'-5"  | 2 x 9'-10" | 3 x 7'-9"  | 1 x 15'-2"  | 2 x 9'-10"  | 3 x 7'-9"  |
| 4.27 (14)  | 1 x 9'-2"                                 | 2 x 6'-5"           | 3 x 5'-2"             | 1 x 10'-0" | 2 x 6'-10"            | 3 x 5'-7"           | 1 x 12'-0"           | 2 x 8'-0"  | 3 x 6'-5"  | 1 x 13'-2"          | 2 x 8'-10" | 3 x 7'-2"  | 1 x 14'-8"  | 2 x 10'-0" | 3 x 8'-0"  | 1 x 16'-10" | 2 x 10'-10" | 3 x 8'-10" |
| 4.88 (16)  | 1 x 9'-2"                                 | 2 x 6'-5"           | 3 x 5'-2"             | 1 x 10'-5" | 2 x 7'-2"             | 3 x 5'-7"           | 1 x 12'-0"           | 2 x 8'-0"  | 3 x 6'-5"  | 1 x 14'-0"          | 2 x 9'-7"  | 3 x 7'-2"  | 1 x 14'-8"  | 2 x 10'-0" | 3 x 8'-0"  | 1 x 16'-10" | 2 x 11'-6"  | 3 x 9'-1"  |
| Vertical Reinforcement   | ICF with 6" Tie Spacing                   | As per table A.1.1. |                       |            |                       | As per table A.1.1. |                      |            |            | As per table A.1.1. |            |            |             |            |            |             |             |            |
| Vertical Reinforcement   | ICF with 8" Tie Spacing                   | As per table A.1.2. |                       |            |                       | As per table A.1.2. |                      |            |            | As per table A.1.2. |            |            |             |            |            |             |             |            |
| Horizontal Reinforcement   | Block Height of 12" and 18"               | 10 M @ 450 (18)     |                       |            |                       | 10 M @ 450 (18)     |                      |            |            | 10 M @ 450 (18)     |            |            |             |            |            |             |             |            |
| Horizontal Reinforcement   | Block Height of 16"                       | 10 M @ 400 (16)     |                       |            |                       | 10 M @ 400 (16)     |                      |            |            | 10 M @ 400 (16)     |            |            |             |            |            |             |             |            |

**NOTES:**

1.  $S_{a,ICF}$  is equivalent spectral response acceleration for ICF walls as provided in Appendix A.
2. This table is to be used in conjunction with the "Design Limitations."
3. Provide two layers of the indicated horizontal and vertical distributed steel specified for 300mm (12") walls. Place each layer as shown in the rebar placement drawing.
4. All four sides of the building are to have a minimum number and length of shear walls that conforms to this table.
5. Use Table A.6 for buildings that do not meet the required wall length of this table.
6. Provide 2-15M concentrated reinforcement at each end of shear walls as shown in shear wall detail.
7. All concentrated reinforcement is to be continues to the bottom of the foundation wall. Provide lap splices as required.
8. Concentrated reinforcement is to be placed in accordance with Bar Placement Detail.

**INSULATING CONCRETE FORMS MANUFACTURERS ASSOCIATION**



**Table A.8.1600. Above Grade Shear Wall Length for Seismic Zone Classification,  $S_{a,ICF} \leq 0.16$  and Hourly Wind Pressure,  $0.5kPa < q1/50 \leq 0.75kPa$  (in a Building With Walkout Basement), where Building Area  $\leq 1600ft^2$**

| Wall Height m (ft)   | Seismic Zone Classification  |            |                       |            |                       |            |
|--|--|------------|-----------------------|------------|-----------------------|------------|
|  | $S_{a,ICF} \leq 0.07$  |            | $S_{a,ICF} \leq 0.11$ |            | $S_{a,ICF} \leq 0.16$ |            |
| <b>Second Floor Walls of Two Story ICF Structure Supporting Wood Frame Roof (TYPE E)</b> |  |            |                       |            |                       |            |
|  | 6" & 8" Thick Wall   |            | 10" & 12" Thick Wall  |            | 10" & 12" Thick Wall  |            |
|  | Number and length of shear walls provided  |            |                       |            |                       |            |
| 2.44 (8)   | 1 x 6'-5"  | 2 x 3'-2"  | 3 x 2'-8"             | 1 x 6'-5"  | 2 x 3'-2"             | 3 x 2'-8"  |
| 2.75 (9)   | 1 x 6'-5"  | 2 x 3'-2"  | 3 x 2'-8"             | 1 x 6'-5"  | 2 x 3'-2"             | 3 x 2'-8"  |
| 3.05 (10)  | 1 x 6'-5"  | 2 x 3'-2"  | 3 x 2'-8"             | 1 x 6'-5"  | 2 x 4'-0"             | 3 x 3'-2"  |
|  | <b>Main Floor Walls of One Story ICF Structure Supporting Wood Frame Roof (TYPE F)</b>                         |            |                       |            |                       |            |
|  | 6" & 8" Thick Wall   |            | 10" & 12" Thick Wall  |            | 10" & 12" Thick Wall  |            |
|  | Number and length of shear walls provided  |            |                       |            |                       |            |
| 2.44 (8)   | 1 x 6'-5"  | 2 x 3'-2"  | 3 x 2'-8"             | 1 x 6'-5"  | 2 x 3'-2"             | 3 x 2'-8"  |
| 2.75 (9)   | 1 x 6'-5"  | 2 x 3'-2"  | 3 x 2'-8"             | 1 x 6'-5"  | 2 x 3'-2"             | 3 x 2'-8"  |
| 3.05 (10)  | 1 x 6'-5"  | 2 x 3'-2"  | 3 x 2'-8"             | 1 x 6'-5"  | 2 x 3'-7"             | 3 x 2'-10" |
| 3.66 (12)  | 1 x 6'-5"  | 2 x 3'-2"  | 3 x 2'-8"             | 1 x 6'-5"  | 2 x 3'-6"             | 3 x 3'-6"  |
| 4.27 (14)  | 1 x 6'-5"  | 2 x 3'-7"  | 3 x 3'-2"             | 1 x 6'-5"  | 2 x 4'-0"             | 3 x 3'-2"  |
| 4.88 (16)  | 1 x 6'-5"  | 2 x 4'-0"  | 3 x 3'-2"             | 1 x 7'-2"  | 2 x 4'-5"             | 3 x 3'-7"  |
|  | <b>Main Floor Walls of Two Story Structure Supporting 2nd Story Wood Framed Walls, Floor and Roof (TYPE G)</b> |            |                       |            |                       |            |
|  | 6" & 8" Thick Wall   |            | 10" & 12" Thick Wall  |            | 10" & 12" Thick Wall  |            |
|  | Number and length of shear walls provided  |            |                       |            |                       |            |
| 2.44 (8)   | 1 x 6'-5"  | 2 x 4'-0"  | 3 x 3'-2"             | 1 x 6'-5"  | 2 x 4'-0"             | 3 x 3'-2"  |
| 2.75 (9)   | 1 x 6'-5"  | 2 x 4'-0"  | 3 x 3'-2"             | 1 x 8'-3"  | 2 x 5'-4"             | 3 x 4'-3"  |
| 3.05 (10)  | 1 x 6'-11"   | 2 x 4'-6"  | 3 x 3'-6"             | 1 x 8'-5"  | 2 x 5'-4"             | 3 x 4'-0"  |
| 3.66 (12)  | 1 x 7'-6"  | 2 x 5'-1"  | 3 x 4'-0"             | 1 x 9'-2"  | 2 x 6'-0"             | 3 x 4'-10" |
| 4.27 (14)  | 1 x 7'-9"  | 2 x 5'-2"  | 3 x 4'-3"             | 1 x 9'-10" | 2 x 6'-8"             | 3 x 5'-2"  |
| 4.88 (16)  | 1 x 8'-0"  | 2 x 5'-7"  | 3 x 4'-5"             | 1 x 10'-2" | 2 x 6'-10"            | 3 x 5'-7"  |
|  | <b>Main Floor Walls of Two Story ICF Structure Supporting Wood Frame Floors and Roof (TYPE H)</b>              |            |                       |            |                       |            |
|  | 6" & 8" Thick Wall   |            | 10" & 12" Thick Wall  |            | 10" & 12" Thick Wall  |            |
|  | Number and length of shear walls provided  |            |                       |            |                       |            |
| 2.44 (8)   | 1 x 7'-6"  | 2 x 4'-10" | 3 x 3'-9"             | 1 x 8'-0"  | 2 x 5'-1"             | 3 x 4'-0"  |
| 2.75 (9)   | 1 x 7'-9"  | 2 x 5'-2"  | 3 x 3'-9"             | 1 x 10'-5" | 2 x 6'-5"             | 3 x 5'-1"  |
| 3.05 (10)  | 1 x 8'-10"   | 2 x 5'-7"  | 3 x 4'-5"             | 1 x 10'-5" | 2 x 6'-8"             | 3 x 5'-2"  |
| 3.66 (12)  | 1 x 9'-2"  | 2 x 6'-0"  | 3 x 4'-10"            | 1 x 11'-2" | 2 x 7'-7"             | 3 x 5'-10" |
| 4.27 (14)  | 1 x 9'-2"  | 2 x 6'-5"  | 3 x 5'-2"             | 1 x 11'-7" | 2 x 8'-0"             | 3 x 6'-2"  |
| 4.88 (16)  | 1 x 9'-2"  | 2 x 6'-5"  | 3 x 5'-2"             | 1 x 12'-0" | 2 x 8'-0"             | 3 x 6'-5"  |
|  | Vertical Reinforcement   |            | As per table A.1.1.   |            | As per table A.1.1.   |            |
|  | ICF with 6" Tie Spacing  |            | As per table A.1.2.   |            | As per table A.1.2.   |            |
|  | ICF with 8" Tie Spacing  |            | As per table A.1.2.   |            | As per table A.1.2.   |            |
|  | Horizontal Reinforcement   |            | 10 M @ 450 (18)       |            | 10 M @ 450 (18)       |            |
|  | Block Height of 12" and 18"  |            | 10 M @ 400 (16)       |            | 10 M @ 400 (16)       |            |

**NOTES:**

1.  $S_{a,ICF}$  is equivalent spectral response acceleration for ICF walls as provided in Appendix A.
2. This table is to be used in conjunction with the "Design Limitations."
3. Provide two layers of the indicated horizontal and vertical distributed steel specified for 300mm (12") walls. Place each layer as shown in the rebar placement drawing.
4. All four sides of the building are to have a minimum number and length of shear walls that conforms to this table.
5. Use Table A.6 for buildings that do not meet the required wall length of this table.
6. Provide 2-15M concentrated reinforcement at each end of shear walls as shown in shear wall detail.
7. All concentrated reinforcement is to be continues to the bottom of the foundation wall. Provide lap splices as required.
8. Concentrated reinforcement is to be placed in accordance with Bar Placement Detail.

# INSULATING CONCRETE FORMS MANUFACTURERS ASSOCIATION



**Table A.9.1600. Above Grade Shear Wall Length for Seismic Zone Classification,  $S_{a,ICF} \leq 0.16$  and Hourly Wind Pressure,  $0.75kPa < q_{1/50} \leq 1.05kPa$  (in a Building With Walkout Basement), where Building Area  $\leq 1600ft^2$**

| Wall Height m (ft)   | Seismic Zone Classification               |                     |                       |                 |                       |            |
|--|---|---------------------|-----------------------|-----------------|-----------------------|------------|
|  | $S_{a,ICF} \leq 0.07$                     |                     | $S_{a,ICF} \leq 0.11$ |                 | $S_{a,ICF} \leq 0.16$ |            |
| <b>Second Floor Walls of Two Story ICF Structure Supporting Wood Frame Roof (TYPE E)</b>                       |   |                     |                       |                 |                       |            |
|  | 6" & 8" Thick Wall                        |                     | 10" & 12" Thick Wall  |                 | 6" & 8" Thick Wall    |            |
|  | Number and length of shear walls provided |                     |                       |                 |                       |            |
| 2.44 (8)   | 1 x 6'-5"                                 | 2 x 3'-2"           | 3 x 2'-8"             | 1 x 6'-5"       | 2 x 3'-2"             | 3 x 2'-8"  |
| 2.75 (9)   | 1 x 6'-5"                                 | 2 x 3'-2"           | 3 x 2'-8"             | 1 x 6'-5"       | 2 x 3'-6"             | 3 x 2'-8"  |
| 3.05 (10)  | 1 x 6'-5"                                 | 2 x 3'-2"           | 3 x 2'-8"             | 1 x 6'-5"       | 2 x 4'-0"             | 3 x 3'-2"  |
| <b>Main Floor Walls of One Story ICF Structure Supporting Wood Frame Roof (TYPE F)</b>                         |   |                     |                       |                 |                       |            |
|  | 6" & 8" Thick Wall                        |                     | 10" & 12" Thick Wall  |                 | 6" & 8" Thick Wall    |            |
|  | Number and length of shear walls provided |                     |                       |                 |                       |            |
| 2.44 (8)   | 1 x 6'-5"                                 | 2 x 3'-2"           | 3 x 2'-8"             | 1 x 6'-5"       | 2 x 3'-2"             | 3 x 2'-8"  |
| 2.75 (9)   | 1 x 6'-5"                                 | 2 x 3'-2"           | 3 x 2'-8"             | 1 x 6'-5"       | 2 x 3'-2"             | 3 x 2'-8"  |
| 3.05 (10)  | 1 x 6'-5"                                 | 2 x 3'-2"           | 3 x 2'-8"             | 1 x 6'-5"       | 2 x 3'-7"             | 3 x 2'-10" |
| 3.66 (12)  | 1 x 6'-5"                                 | 2 x 3'-2"           | 3 x 2'-8"             | 1 x 6'-5"       | 2 x 3'-6"             | 3 x 3'-6"  |
| 4.27 (14)  | 1 x 6'-5"                                 | 2 x 3'-7"           | 3 x 3'-2"             | 1 x 6'-5"       | 2 x 4'-10"            | 3 x 3'-9"  |
| 4.88 (16)  | 1 x 6'-5"                                 | 2 x 4'-0"           | 3 x 3'-2"             | 1 x 7'-2"       | 2 x 4'-5"             | 3 x 3'-7"  |
| <b>Main Floor Walls of Two Story Structure Supporting 2nd Story Wood Framed Walls, Floor and Roof (TYPE G)</b> |   |                     |                       |                 |                       |            |
|  | 6" & 8" Thick Wall                        |                     | 10" & 12" Thick Wall  |                 | 6" & 8" Thick Wall    |            |
|  | Number and length of shear walls provided |                     |                       |                 |                       |            |
| 2.44 (8)   | 1 x 6'-5"                                 | 2 x 4'-0"           | 3 x 3'-2"             | 1 x 6'-5"       | 2 x 4'-0"             | 3 x 3'-2"  |
| 2.75 (9)   | 1 x 6'-5"                                 | 2 x 4'-0"           | 3 x 3'-2"             | 1 x 6'-8"       | 2 x 4'-3"             | 3 x 3'-2"  |
| 3.05 (10)  | 1 x 6'-11"                                | 2 x 4'-6"           | 3 x 3'-6"             | 1 x 6'-10"      | 2 x 4'-5"             | 3 x 3'-6"  |
| 3.66 (12)  | 1 x 7'-6"                                 | 2 x 5'-1"           | 3 x 4'-0"             | 1 x 7'-6"       | 2 x 5'-1"             | 3 x 4'-0"  |
| 4.27 (14)  | 1 x 7'-9"                                 | 2 x 5'-2"           | 3 x 4'-3"             | 1 x 8'-3"       | 2 x 5'-4"             | 3 x 4'-3"  |
| 4.88 (16)  | 1 x 8'-0"                                 | 2 x 5'-7"           | 3 x 4'-5"             | 1 x 8'-10"      | 2 x 5'-7"             | 3 x 4'-5"  |
| <b>Main Floor Walls of Two Story ICF Structure Supporting Wood Frame Floors and Roof (TYPE H)</b>              |   |                     |                       |                 |                       |            |
|  | 6" & 8" Thick Wall                        |                     | 10" & 12" Thick Wall  |                 | 6" & 8" Thick Wall    |            |
|  | Number and length of shear walls provided |                     |                       |                 |                       |            |
| 2.44 (8)   | 1 x 7'-6"                                 | 2 x 4'-10"          | 3 x 3'-9"             | 1 x 8'-0"       | 2 x 5'-1"             | 3 x 4'-0"  |
| 2.75 (9)   | 1 x 7'-9"                                 | 2 x 5'-2"           | 3 x 3'-9"             | 1 x 8'-10"      | 2 x 5'-7"             | 3 x 4'-3"  |
| 3.05 (10)  | 1 x 8'-10"                                | 2 x 5'-7"           | 3 x 4'-5"             | 1 x 8'-5"       | 2 x 5'-4"             | 3 x 4'-0"  |
| 3.66 (12)  | 1 x 9'-2"                                 | 2 x 6'-0"           | 3 x 4'-10"            | 1 x 9'-2"       | 2 x 6'-0"             | 3 x 4'-10" |
| 4.27 (14)  | 1 x 9'-2"                                 | 2 x 6'-5"           | 3 x 5'-2"             | 1 x 9'-10"      | 2 x 6'-8"             | 3 x 5'-2"  |
| 4.88 (16)  | 1 x 9'-2"                                 | 2 x 6'-5"           | 3 x 5'-2"             | 1 x 10'-0"      | 2 x 6'-10"            | 3 x 5'-7"  |
| Vertical Reinforcement   | ICF with 6" Tie Spacing                   | As per table A.1.1. |                       |                 | As per table A.1.1.   |            |
| Vertical Reinforcement   | ICF with 8" Tie Spacing                   | As per table A.1.2. |                       |                 | As per table A.1.2.   |            |
| Horizontal Reinforcement   | Block Height of 12" and 18"               | 10 M @ 450 (18)     |                       | 10 M @ 450 (18) |                       |            |
| Horizontal Reinforcement   | Block Height of 16"                       | 10 M @ 400 (16)     |                       | 10 M @ 400 (16) |                       |            |

**NOTES:**

1.  $S_{a,ICF}$  is equivalent spectral response acceleration for ICF walls as provided in Appendix A.
2. This table is to be used in conjunction with the "Design Limitations."
3. Provide two layers of the indicated horizontal and vertical distributed steel specified for 300mm (12") walls. Place each layer as shown in the rebar placement drawing.
4. All four sides of the building are to have a minimum number and length of shear walls that conforms to this table.
5. Use Table A.6 for buildings that do not meet the required wall length of this table.
6. Provide 2-15M concentrated reinforcement at each end of shear walls as shown in shear wall detail.
7. All concentrated reinforcement is to be continues to the bottom of the foundation wall. Provide lap splices as required.
8. Concentrated reinforcement is to be placed in accordance with Bar Placement Detail.

INSULATING CONCRETE FORMS MANUFACTURERS ASSOCIATION



**Table A.10.1600. Above Grade Shear Wall Length for Seismic Zone Classification,  $S_{a,ICF} > 0.16$  and Hourly Wind Pressure,  $q_{1/50} \leq 1.05kPa$  (in a Building With Walkout Basement), where Building Area  $\leq 1600ft^2$**

| Wall Height m (ft)   | Seismic Zone Classification               |                               |                                |                                |                                |                                |                                |                                |
|--|---|-------------------------------|--------------------------------|--------------------------------|--------------------------------|--------------------------------|--------------------------------|--------------------------------|
|  | $S_{a,ICF} \leq 0.16$                     |                               | $S_{a,ICF} \leq 0.31$          |                                | $S_{a,ICF} \leq 0.53$          |                                | $S_{a,ICF} \leq 0.79$          |                                |
| <b>Second Floor Walls of Two Story ICF Structure Supporting Wood Frame Roof (TYPE E)</b>                       |   |                               |                                |                                |                                |                                |                                |                                |
|  | 6" & 8" Thick Wall                        | 10" & 12" Thick Wall          | 6" & 8" Thick Wall             | 10" & 12" Thick Wall           | 6" & 8" Thick Wall             | 10" & 12" Thick Wall           | 6" & 8" Thick Wall             | 10" & 12" Thick Wall           |
|  | Number and length of shear walls provided |                               |                                |                                |                                |                                |                                |                                |
| 2.44 (8)   | 1x 6'-5" 2x 3'-2" 3x 2'-8"                | 1x 6'-5" 2x 3'-2" 3x 2'-8"    | 1x 7'-2" 2x 4'-10" 3x 4'-0"    | 1x 7'-2" 2x 4'-10" 3x 4'-0"    | 1x 8'-10" 2x 6'-0" 3x 4'-10"   | 1x 9'-2" 2x 6'-5" 3x 5'-1"     | 1x 10'-0" 2x 6'-10" 3x 5'-7"   | 1x 10'-0" 2x 7'-2" 3x 5'-7"    |
| 2.75 (9)   | 1x 6'-5" 2x 3'-2" 3x 2'-10"               | 1x 6'-5" 2x 3'-2" 3x 2'-10"   | 1x 8'-0" 2x 5'-7" 3x 4'-6"     | 1x 8'-0" 2x 5'-7" 3x 4'-6"     | 1x 10'-0" 2x 6'-10" 3x 5'-7"   | 1x 10'-0" 2x 7'-2" 3x 5'-7"    | 1x 10'-0" 2x 7'-2" 3x 5'-7"    | 1x 12'-0" 2x 8'-5" 3x 6'-10"   |
| 3.05 (10)  | 1x 6'-5" 2x 4'-0" 3x 3'-2"                | 1x 6'-5" 2x 4'-0" 3x 3'-2"    | 1x 8'-10" 2x 6'-0" 3x 5'-0"    | 1x 8'-10" 2x 6'-0" 3x 5'-0"    | 1x 10'-0" 2x 7'-2" 3x 5'-0"    | 1x 11'-2" 2x 7'-7" 3x 6'-0"    | 1x 12'-0" 2x 8'-5" 3x 6'-10"   | 1x 12'-0" 2x 8'-5" 3x 6'-10"   |
| <b>Main Floor Walls of One Story ICF Structure Supporting Wood Frame Roof (TYPE F)</b>                         |   |                               |                                |                                |                                |                                |                                |                                |
|  | 6" & 8" Thick Wall                        | 10" & 12" Thick Wall          | 6" & 8" Thick Wall             | 10" & 12" Thick Wall           | 6" & 8" Thick Wall             | 10" & 12" Thick Wall           | 6" & 8" Thick Wall             | 10" & 12" Thick Wall           |
|  | Number and length of shear walls provided |                               |                                |                                |                                |                                |                                |                                |
| 2.44 (8)   | 1x 6'-5" 2x 3'-2" 3x 2'-8"                | 1x 6'-5" 2x 3'-2" 3x 2'-8"    | 1x 7'-2" 2x 4'-0" --           | 1x 7'-2" 2x 4'-5" 3x 4'-0"     | 1x 8'-0" 2x 5'-7" 3x 4'-5"     | 1x 8'-5" 2x 5'-7" 3x 4'-5"     | 1x 8'-10" 2x 6'-5" 3x 5'-2"    | 1x 9'-7" 2x 6'-5" 3x 5'-2"     |
| 2.75 (9)   | 1x 6'-5" 2x 3'-2" 3x 2'-8"                | 1x 6'-5" 2x 3'-2" 3x 2'-8"    | 1x 7'-2" 2x 4'-10" 3x 4'-6"    | 1x 8'-0" 2x 4'-10" 3x 4'-6"    | 1x 9'-2" 2x 6'-5" 3x 4'-10"    | 1x 9'-2" 2x 6'-5" 3x 5'-2"     | 1x 10'-0" 2x 7'-2" 3x 5'-7"    | 1x 10'-5" 2x 7'-2" 3x 5'-7"    |
| 3.05 (10)  | 1x 6'-5" 2x 3'-7" 3x 2'-10"               | 1x 6'-5" 2x 4'-0" 3x 2'-10"   | 1x 8'-0" 2x 5'-7" 3x 5'-0"     | 1x 8'-10" 2x 5'-7" 3x 5'-0"    | 1x 10'-0" 2x 6'-10" 3x 5'-7"   | 1x 10'-5" 2x 7'-2" 3x 5'-7"    | 1x 11'-2" 2x 8'-0" 3x 6'-5"    | 1x 11'-7" 2x 8'-0" 3x 6'-5"    |
| 3.66 (12)  | 1x 6'-5" 2x 4'-0" 3x 3'-6"                | 1x 7'-7" 2x 5'-1" 3x 4'-0"    | 1x 8'-10" 2x 6'-0" --          | 1x 10'-0" 2x 7'-2" 3x 6'-0"    | 1x 12'-0" 2x 8'-5" 3x 6'-10"   | 1x 12'-5" 2x 8'-5" 3x 6'-10"   | 1x 13'-7" 2x 9'-2" 3x 7'-7"    | 1x 14'-0" 2x 9'-2" 3x 7'-7"    |
| 4.27 (14)  | 1x 7'-2" 2x 5'-1" 3x 4'-0"                | 1x 7'-7" 2x 5'-2" 3x 4'-0"    | 1x 10'-5" 2x 7'-2" 3x 7'-0"    | 1x 10'-10" 2x 7'-4" 3x 7'-0"   | 1x 14'-0" 2x 9'-7" 3x 7'-0"    | 1x 14'-5" 2x 10'-0" 3x 8'-0"   | 1x 15'-4" 2x 10'-10" 3x 8'-0"  | 1x 16'-4" 2x 11'-2" 3x 10'-0"  |
| 4.88 (16)  | 1x 7'-7" 2x 5'-2" 3x 4'-4"                | 1x 8'-6" 2x 5'-10" 3x 4'-6"   | 1x 10'-10" 2x 8'-0" --         | 1x 12'-4" 2x 8'-5" 3x 8'-0"    | 1x 15'-2" 2x 10'-0" 3x 8'-0"   | 1x 16'-6" 2x 11'-6" 3x 9'-2"   | 1x 17'-7" 2x 12'-4" 3x 10'-0"  | 1x 18'-6" 2x 12'-10" 3x 10'-5" |
| <b>Main Floor Walls of Two Story Structure Supporting 2nd Story Wood Framed Walls, Floor and Roof (TYPE G)</b> |   |                               |                                |                                |                                |                                |                                |                                |
|  | 6" & 8" Thick Wall                        | 10" & 12" Thick Wall          | 6" & 8" Thick Wall             | 10" & 12" Thick Wall           | 6" & 8" Thick Wall             | 10" & 12" Thick Wall           | 6" & 8" Thick Wall             | 10" & 12" Thick Wall           |
|  | Number and length of shear walls provided |                               |                                |                                |                                |                                |                                |                                |
| 2.44 (8)   | 1x 8'-0" 2x 5'-2" 3x 4'-0"                | 1x 8'-0" 2x 5'-2" 3x 4'-0"    | 1x 11'-2" 2x 7'-7" 3x 6'-0"    | 1x 11'-2" 2x 7'-7" 3x 6'-0"    | 1x 15'-2" 2x 10'-5" 3x 6'-10"  | 1x 15'-2" 2x 10'-5" 3x 6'-10"  | 1x 16'-0" 2x 11'-2" 3x 9'-7"   | 1x 16'-0" 2x 11'-2" 3x 9'-7"   |
| 2.75 (9)   | 1x 8'-0" 2x 5'-7" 3x 4'-10"               | 1x 8'-10" 2x 5'-7" 3x 4'-10"  | 1x 12'-0" 2x 8'-0" 3x 6'-0"    | 1x 12'-0" 2x 8'-0" 3x 6'-0"    | 1x 16'-5" 2x 11'-2" 3x 8'-10"  | 1x 16'-5" 2x 11'-2" 3x 8'-10"  | 1x 16'-0" 2x 11'-2" 3x 9'-7"   | 1x 16'-0" 2x 11'-2" 3x 9'-7"   |
| 3.05 (10)  | 1x 8'-10" 2x 6'-0" 3x 4'-10"              | 1x 8'-10" 2x 6'-0" 3x 4'-10"  | 1x 12'-10" 2x 8'-10" 3x 6'-10" | 1x 13'-7" 2x 8'-10" 3x 6'-10"  | 1x 17'-2" 2x 11'-7" 3x 9'-2"   | 1x 17'-2" 2x 11'-7" 3x 9'-2"   | 1x 17'-7" 2x 12'-2" 3x 9'-7"   | 1x 17'-7" 2x 12'-2" 3x 9'-7"   |
| 3.66 (12)  | 1x 9'-2" 2x 6'-5" 3x 5'-2"                | 1x 10'-5" 2x 7'-2" 3x 5'-7"   | 1x 12'-10" 2x 9'-2" 3x 7'-2"   | 1x 14'-0" 2x 10'-0" 3x 8'-0"   | 1x 17'-2" 2x 12'-0" 3x 9'-7"   | 1x 17'-2" 2x 12'-0" 3x 9'-7"   | 1x 19'-2" 2x 13'-2" 3x 11'-2"  | 1x 19'-2" 2x 13'-2" 3x 11'-2"  |
| 4.27 (14)  | 1x 10'-0" 2x 6'-10" 3x 5'-7"              | 1x 10'-5" 2x 7'-2" 3x 5'-7"   | 1x 14'-0" 2x 9'-7" 3x 8'-0"    | 1x 14'-10" 2x 10'-0" 3x 8'-0"  | 1x 19'-2" 2x 13'-2" 3x 10'-5"  | 1x 19'-2" 2x 13'-2" 3x 10'-5"  | 1x 20'-10" 2x 14'-5" 3x 12'-0" | 1x 20'-10" 2x 14'-5" 3x 12'-0" |
| 4.88 (16)  | 1x 10'-0" 2x 6'-10" 3x 5'-7"              | 1x 10'-10" 2x 7'-2" 3x 6'-0"  | 1x 14'-0" 2x 9'-7" 3x 8'-0"    | 1x 15'-2" 2x 10'-5" 3x 8'-5"   | 1x 19'-2" 2x 13'-2" 3x 10'-5"  | 1x 20'-10" 2x 14'-5" 3x 11'-7" | 1x 22'-8" 2x 16'-0" 3x 12'-10" | 1x 23'-2" 2x 16'-0" 3x 13'-0"  |
| <b>Main Floor Walls of Two Story ICF Structure Supporting Wood Frame Floors and Roof (TYPE H)</b>              |   |                               |                                |                                |                                |                                |                                |                                |
|  | 6" & 8" Thick Wall                        | 10" & 12" Thick Wall          | 6" & 8" Thick Wall             | 10" & 12" Thick Wall           | 6" & 8" Thick Wall             | 10" & 12" Thick Wall           | 6" & 8" Thick Wall             | 10" & 12" Thick Wall           |
|  | Number and length of shear walls provided |                               |                                |                                |                                |                                |                                |                                |
| 2.44 (8)   | 1x 9'-7" 2x 6'-5" 3x 5'-2"                | 1x 10'-0" 2x 6'-10" 3x 5'-2"  | 1x 13'-7" 2x 9'-7" 3x 7'-2"    | 1x 14'-5" 2x 9'-7" 3x 7'-2"    | 1x 16'-10" 2x 12'-0" 3x 9'-7"  | 1x 17'-7" 2x 12'-0" 3x 9'-7"   | 1x 18'-5" 2x 12'-10" 3x 11'-2" | 1x 19'-4" 2x 13'-7" 3x 11'-2"  |
| 2.75 (9)   | 1x 10'-5" 2x 7'-2" 3x 5'-7"               | 1x 10'-5" 2x 7'-2" 3x 5'-7"   | 1x 14'-5" 2x 10'-5" 3x 8'-0"   | 1x 16'-0" 2x 10'-5" 3x 8'-0"   | 1x 17'-7" 2x 12'-4" 3x 10'-5"  | 1x 18'-5" 2x 12'-10" 3x 10'-5" | 1x 19'-6" 2x 13'-7" 3x 11'-2"  | 1x 20'-4" 2x 14'-5" 3x 11'-6"  |
| 3.05 (10)  | 1x 11'-2" 2x 7'-7" 3x 6'-0"               | 1x 11'-2" 2x 8'-0" 3x 6'-0"   | 1x 15'-2" 2x 10'-5" 3x 8'-10"  | 1x 16'-0" 2x 11'-2" 3x 8'-10"  | 1x 18'-5" 2x 12'-10" 3x 10'-5" | 1x 19'-2" 2x 13'-7" 3x 11'-2"  | 1x 20'-10" 2x 14'-5" 3x 12'-0" | 1x 21'-7" 2x 15'-2" 3x 12'-0"  |
| 3.66 (12)  | 1x 11'-2" 2x 7'-7" 3x 6'-0"               | 1x 12'-10" 2x 8'-10" 3x 7'-0" | 1x 16'-0" 2x 10'-6" 3x 8'-10"  | 1x 18'-5" 2x 12'-10" 3x 10'-0" | 1x 20'-4" 2x 14'-5" 3x 11'-4"  | 1x 21'-0" 2x 14'-8" 3x 12'-0"  | 1x 22'-6" 2x 15'-0" 3x 12'-10" | 1x 24'-0" 2x 16'-6" 3x 13'-7"  |
| 4.27 (14)  | 1x 12'-0" 2x 8'-4" 3x 6'-5"               | 1x 12'-10" 2x 8'-10" 3x 7'-0" | 1x 16'-10" 2x 12'-0" 3x 9'-7"  | 1x 18'-5" 2x 12'-10" 3x 10'-0" | 1x 22'-5" 2x 15'-6" 3x 12'-5"  | 1x 23'-0" 2x 16'-0" 3x 12'-10" | 1x 24'-10" 2x 17'-4" 3x 14'-0" | 1x 26'-0" 2x 18'-0" 3x 14'-6"  |
| 4.88 (16)  | 1x 12'-0" 2x 8'-4" 3x 6'-5"               | 1x 13'-7" 2x 9'-0" 3x 7'-2"   | 1x 16'-10" 2x 12'-0" 3x 9'-7"  | 1x 18'-5" 2x 12'-10" 3x 10'-4" | 1x 22'-5" 2x 15'-6" 3x 12'-5"  | 1x 23'-0" 2x 17'-4" 3x 14'-0"  | 1x 27'-2" 2x 18'-8" 3x 15'-2"  | 1x 28'-0" 2x 19'-6" 3x 16'-0"  |
| Vertical Reinforcement   | ICF with 6" Tie Spacing                   | As per table A.2.1.           | As per table A.2.1.            | As per table A.2.1.            | As per table A.2.1.            | As per table A.2.1.            | As per table A.2.1.            | As per table A.2.1.            |
| ICF with 8" Tie Spacing  | As per table A.2.2.                       | As per table A.2.2.           | As per table A.2.2.            | As per table A.2.2.            | As per table A.2.2.            | As per table A.2.2.            | As per table A.2.2.            | As per table A.2.2.            |
| Horizontal Reinforcement   | Block Height of 12" and 18"               | As per table A.2.1.           | As per table A.2.1.            | As per table A.2.1.            | As per table A.2.1.            | As per table A.2.1.            | As per table A.2.1.            | As per table A.2.1.            |
| Block Height of 10"  | As per table A.2.2.                       | As per table A.2.2.           | As per table A.2.2.            | As per table A.2.2.            | As per table A.2.2.            | As per table A.2.2.            | As per table A.2.2.            | As per table A.2.2.            |

**NOTES:**

1.  $S_{a,ICF}$  is equivalent spectral response acceleration for ICF walls as provided in Appendix A.
2. This table is to be used in conjunction with the "Design Limitations."
3. Provide two layers of the indicated horizontal and vertical distributed steel specified for 300mm (12") walls. Place each layer as shown in the rebar placement drawing.
4. All four sides of the building are to have a minimum number and length of shear walls that conforms to this table.
5. Provide 2-15M concentrated reinforcement at each end of shear walls as shown in shear wall detail.
6. All concentrated reinforcement is to be continues to the bottom of the foundation wall. Provide lap splices as required.
7. Concentrated reinforcement is to be placed in accordance with Bar Placement Detail.
8. Horizontal reinforcement in shear walls where  $S_{a,ICF} > 0.16$  must be anchored using a standard 180° hook around vertical end bars.
9. When using this table for  $S_{a,ICF} \leq 0.16$ , use the vertical and horizontal distributed steel in Tables A.2.1. or A.2.2.

# INSULATING CONCRETE FORMS MANUFACTURERS ASSOCIATION

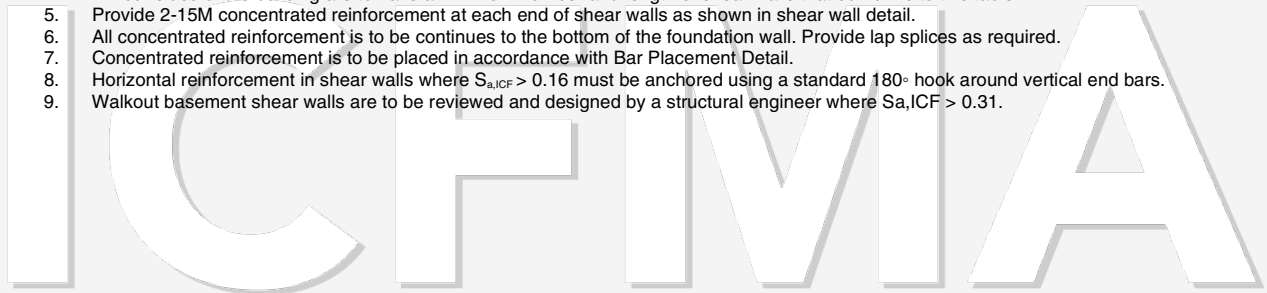

**Table A. 11.1600. – Above Grade Walkout Basement Shear Wall Length for Seismic Zone Classification,  $S_{a,ICF} \leq 0.31$  and Hourly Wind Pressure,  $q/50 \leq 1.05kPa$ , where Building Area  $\leq 1600ft^2$**

| Wall Height m (ft)  | Seismic Zone Classification               |                              |                              |                              |                                |                                |                                |                                |
|---|---|------------------------------|------------------------------|------------------------------|--------------------------------|--------------------------------|--------------------------------|--------------------------------|
|   | $S_{a,ICF} \leq 0.07$                     |                              | $S_{a,ICF} \leq 0.11$        |                              | $S_{a,ICF} \leq 0.16$          |                                | $S_{a,ICF} \leq 0.31$          |                                |
|   | 6" & 8" Thick Wall                        | 10" & 12" Thick Wall         | 6" & 8" Thick Wall           | 10" & 12" Thick Wall         | 6" & 8" Thick Wall             | 10" & 12" Thick Wall           | 6" & 8" Thick Wall             | 10" & 12" Thick Wall           |
| <b>Walkout Basement Wall of a Single Story ICF Structure Supporting Wood Framed Roof (TYPE W1)</b>  |   |                              |                              |                              |                                |                                |                                |                                |
|   | Number and length of shear walls provided |                              |                              |                              |                                |                                |                                |                                |
| 2.44 (8)  | 1x 8'-0" 2x 4'-5" 3x 3'-7"                | 1x 6'-10" 2x 4'-10" 3x 3'-7" | 1x 8'-3" 2x 5'-7" 3x 4'-5"   | 1x 8'-6" 2x 6'-0" 3x 4'-10"  | 1x 10'-0" 2x 6'-10" 3x 5'-7"   | 1x 10'-6" 2x 7'-2" 3x 5'-9"    | 1x 14'-5" 2x 9'-9" 3x 8'-0"    | 1x 15'-2" 2x 10'-5" 3x 8'-3"   |
| 2.75 (9)  | 1x 6'-6" 2x 4'-5" 3x 3'-7"                | 1x 7'-2" 2x 4'-10" 3x 4'-0"  | 1x 8'-5" 2x 5'-9" 3x 4'-10"  | 1x 8'-10" 2x 6'-0" 3x 4'-10" | 1x 10'-3" 2x 7'-2" 3x 5'-7"    | 1x 10'-9" 2x 7'-4" 3x 5'-10"   | 1x 14'-6" 2x 10'-0" 3x 8'-3"   | 1x 15'-6" 2x 10'-8" 3x 8'-6"   |
| 3.05 (10)   | 1x 6'-10" 2x 4'-10" 3x 3'-7"              | 1x 7'-2" 2x 5'-2" 3x 4'-0"   | 1x 8'-8" 2x 6'-0" 3x 4'-10"  | 1x 9'-0" 2x 6'-3" 3x 5'-0"   | 1x 10'-6" 2x 7'-2" 3x 6'-0"    | 1x 11'-3" 2x 7'-7" 3x 6'-3"    | 1x 15'-0" 2x 10'-5" 3x 8'-5"   | 1x 15'-9" 2x 11'-0" 3x 8'-10"  |
| 3.66 (12)   | 1x 7'-2" 2x 5'-0" 3x 4'-0"                | 1x 8'-0" 2x 5'-2" 3x 4'-5"   | 1x 9'-3" 2x 6'-5" 3x 5'-2"   | 1x 9'-7" 2x 6'-6" 3x 5'-2"   | 1x 11'-3" 2x 7'-7" 3x 6'-5"    | 1x 11'-9" 2x 8'-0" 3x 6'-5"    | 1x 15'-9" 2x 11'-0" 3x 8'-5"   | 1x 16'-10" 2x 11'-6" 3x 9'-2"  |
| <b>Walkout Basement Walls of a Two Story Wood Framed Structure Supporting Wood Frame Floors and Roof (TYPE W2)</b>                              |   |                              |                              |                              |                                |                                |                                |                                |
|   | 6" & 8" Thick Wall                        | 10" & 12" Thick Wall         | 6" & 8" Thick Wall           | 10" & 12" Thick Wall         | 6" & 8" Thick Wall             | 10" & 12" Thick Wall           | 6" & 8" Thick Wall             | 10" & 12" Thick Wall           |
|   | Number and length of shear walls provided |                              |                              |                              |                                |                                |                                |                                |
| 2.44 (8)  | 1x 8'-0" 2x 5'-6" 3x 4'-6"                | 1x 7'-7" 2x 5'-2" 3x 4'-6"   | 1x 8'-5" 2x 6'-0" 3x 4'-10"  | 1x 8'-5" 2x 6'-0" 3x 4'-10"  | 1x 10'-5" 2x 7'-2" 3x 5'-7"    | 1x 10'-5" 2x 7'-2" 3x 5'-7"    | 1x 14'-5" 2x 10'-0" 3x 8'-0"   | 1x 14'-5" 2x 10'-0" 3x 8'-0"   |
| 2.75 (9)  | 1x 8'-3" 2x 5'-8" 3x 4'-6"                | 1x 8'-0" 2x 5'-6" 3x 4'-6"   | 1x 8'-10" 2x 6'-5" 3x 4'-10" | 1x 8'-10" 2x 6'-5" 3x 4'-10" | 1x 10'-5" 2x 7'-6" 3x 5'-10"   | 1x 10'-5" 2x 7'-6" 3x 5'-10"   | 1x 14'-10" 2x 10'-5" 3x 8'-3"  | 1x 14'-10" 2x 10'-5" 3x 8'-3"  |
| 3.05 (10)   | 1x 8'-6" 2x 5'-9" 3x 4'-8"                | 1x 8'-0" 2x 5'-7" 3x 4'-8"   | 1x 8'-10" 2x 6'-5" 3x 4'-10" | 1x 8'-10" 2x 6'-5" 3x 4'-10" | 1x 10'-5" 2x 7'-6" 3x 5'-10"   | 1x 10'-5" 2x 7'-6" 3x 5'-10"   | 1x 15'-2" 2x 10'-8" 3x 8'-5"   | 1x 15'-2" 2x 10'-8" 3x 8'-5"   |
| 3.66 (12)   | 1x 9'-0" 2x 6'-3" 3x 5'-0"                | 1x 8'-6" 2x 6'-0" 3x 5'-0"   | 1x 9'-2" 2x 6'-5" 3x 5'-2"   | 1x 9'-2" 2x 6'-5" 3x 5'-2"   | 1x 11'-2" 2x 7'-7" 3x 6'-2"    | 1x 11'-2" 2x 7'-7" 3x 6'-2"    | 1x 15'-7" 2x 10'-10" 3x 8'-10" | 1x 15'-7" 2x 10'-10" 3x 8'-10" |
| <b>Walkout Basement Wall of a Two Story Building with Main Floor ICF Walls Supporting 2nd Story Wood Framed Walls, Floor and Roof (TYPE W3)</b> |   |                              |                              |                              |                                |                                |                                |                                |
|   | 6" & 8" Thick Wall                        | 10" & 12" Thick Wall         | 6" & 8" Thick Wall           | 10" & 12" Thick Wall         | 6" & 8" Thick Wall             | 10" & 12" Thick Wall           | 6" & 8" Thick Wall             | 10" & 12" Thick Wall           |
|   | Number and length of shear walls provided |                              |                              |                              |                                |                                |                                |                                |
| 2.44 (8)  | 1x 8'-0" 2x 5'-7" 3x 4'-6"                | 1x 8'-0" 2x 5'-10" 3x 4'-6"  | 1x 10'-0" 2x 6'-10" 3x 5'-7" | 1x 10'-0" 2x 6'-10" 3x 5'-7" | 1x 12'-0" 2x 8'-5" 3x 6'-11"   | 1x 12'-0" 2x 8'-5" 3x 6'-11"   | 1x 17'-0" 2x 12'-0" 3x 9'-7"   | 1x 17'-0" 2x 12'-0" 3x 9'-7"   |
| 2.75 (9)  | 1x 8'-3" 2x 5'-10" 3x 4'-5"               | 1x 8'-3" 2x 5'-10" 3x 4'-6"  | 1x 10'-3" 2x 7'-2" 3x 5'-7"  | 1x 10'-3" 2x 7'-2" 3x 5'-7"  | 1x 12'-10" 2x 8'-6" 3x 6'-11"  | 1x 12'-10" 2x 8'-10" 3x 6'-11" | 1x 17'-4" 2x 12'-3" 3x 9'-10"  | 1x 17'-9" 2x 12'-5" 3x 10'-0"  |
| 3.05 (10)   | 1x 8'-6" 2x 5'-10" 3x 4'-8"               | 1x 8'-6" 2x 5'-10" 3x 4'-6"  | 1x 10'-5" 2x 7'-2" 3x 5'-10" | 1x 10'-6" 2x 7'-2" 3x 5'-10" | 1x 12'-10" 2x 8'-10" 3x 6'-11" | 1x 12'-10" 2x 8'-10" 3x 6'-11" | 1x 17'-9" 2x 12'-5" 3x 10'-0"  | 1x 18'-3" 2x 12'-9" 3x 10'-3"  |
| 3.66 (12)   | 1x 9'-0" 2x 6'-3" 3x 5'-0"                | 1x 9'-0" 2x 6'-3" 3x 5'-0"   | 1x 10'-10" 2x 7'-7" 3x 6'-0" | 1x 11'-0" 2x 7'-7" 3x 6'-3"  | 1x 13'-1" 2x 9'-1" 3x 7'-3"    | 1x 13'-4" 2x 9'-3" 3x 7'-6"    | 1x 18'-6" 2x 13'-0" 3x 10'-5"  | 1x 19'-0" 2x 13'-2" 3x 10'-8"  |
| <b>Walkout Basement Wall of Two Story ICF Structure Supporting Wood Frame Floors and Roof (TYPE W4)</b>   |   |                              |                              |                              |                                |                                |                                |                                |
|   | 6" & 8" Thick Wall                        | 10" & 12" Thick Wall         | 6" & 8" Thick Wall           | 10" & 12" Thick Wall         | 6" & 8" Thick Wall             | 10" & 12" Thick Wall           | 6" & 8" Thick Wall             | 10" & 12" Thick Wall           |
|   | Number and length of shear walls provided |                              |                              |                              |                                |                                |                                |                                |
| 2.44 (8)  | 1x 9'-0" 2x 6'-3" 3x 5'-1"                | 1x 9'-7" 2x 6'-5" 3x 5'-3"   | 1x 11'-4" 2x 8'-0" 3x 6'-6"  | 1x 12'-0" 2x 8'-3" 3x 6'-8"  | 1x 14'-0" 2x 9'-7" 3x 7'-9"    | 1x 14'-8" 2x 10'-0" 3x 8'-3"   | 1x 19'-8" 2x 13'-7" 3x 11'-0"  | 1x 20'-8" 2x 14'-5" 3x 11'-6"  |
| 2.75 (9)  | 1x 9'-2" 2x 6'-5" 3x 5'-1"                | 1x 9'-7" 2x 6'-6" 3x 5'-3"   | 1x 12'-0" 2x 8'-0" 3x 6'-6"  | 1x 12'-3" 2x 8'-5" 3x 6'-10" | 1x 14'-5" 2x 9'-10" 3x 8'-0"   | 1x 15'-0" 2x 10'-3" 3x 8'-4"   | 1x 20'-0" 2x 14'-0" 3x 11'-2"  | 1x 21'-3" 2x 14'-8" 3x 11'-9"  |
| 3.05 (10)   | 1x 9'-4" 2x 6'-5" 3x 5'-3"                | 1x 9'-9" 2x 6'-8" 3x 5'-4"   | 1x 12'-0" 2x 8'-3" 3x 6'-10" | 1x 12'-6" 2x 8'-6" 3x 7'-0"  | 1x 14'-5" 2x 10'-0" 3x 8'-3"   | 1x 15'-3" 2x 10'-6" 3x 8'-5"   | 1x 20'-6" 2x 14'-5" 3x 11'-6"  | 1x 21'-6" 2x 15'-0" 3x 12'-0"  |
| 3.66 (12)   | 1x 9'-9" 2x 6'-3" 3x 5'-4"                | 1x 10'-3" 2x 7'-0" 3x 5'-7"  | 1x 12'-4" 2x 8'-6" 3x 7'-0"  | 1x 13'-0" 2x 9'-0" 3x 7'-2"  | 1x 15'-0" 2x 10'-11" 3x 8'-10" | 1x 15'-9" 2x 10'-11" 3x 8'-10" | 1x 21'-3" 2x 14'-9" 3x 11'-6"  | 1x 22'-6" 2x 15'-6" 3x 12'-6"  |
| Vertical Reinforcement  | 6", 8" and 10" thick wall                 | 15 M @ 300 (12)              | 10 M @ 300 (12)              | 15 M @ 300 (12)              | 15 M @ 300 (12)                | 10 M @ 300 (12)                | 15 M @ 300 (12)                | 10 M @ 300 (12)                |
| Horizontal Reinforcement  | Block Height of 12" and 18"               | 10 M @ 450 (18)              | 10 M @ 450 (18)              | 10 M @ 450 (18)              | 10 M @ 450 (18)                | 10 M @ 450 (18)                | 10 M @ 450 (18)                | 10 M @ 450 (18)                |
|   | Block Height of 16"                       | 10 M @ 400 (16)              | 10 M @ 400 (16)              | 10 M @ 400 (16)              | 10 M @ 400 (16)                | 10 M @ 400 (16)                | 10 M @ 400 (16)                | 10 M @ 400 (16)                |

**NOTES:**

1.  $S_{a,ICF}$  is equivalent spectral response acceleration for ICF walls as provided in Appendix A.
2. This table is to be used in conjunction with the "Design Limitations."
3. Provide two layers of the indicated horizontal and vertical distributed steel specified for 300mm (12") walls. Place each layer as shown in the rebar placement drawing.
4. All four sides of the building are to have a minimum number and length of shear walls that conforms to this table.
5. Provide 2-15M concentrated reinforcement at each end of shear walls as shown in shear wall detail.
6. All concentrated reinforcement is to be continues to the bottom of the foundation wall. Provide lap splices as required.
7. Concentrated reinforcement is to be placed in accordance with Bar Placement Detail.
8. Horizontal reinforcement in shear walls where  $S_{a,ICF} > 0.16$  must be anchored using a standard 180° hook around vertical end bars.
9. Walkout basement shear walls are to be reviewed and designed by a structural engineer where  $S_{a,ICF} > 0.31$ .



# INSULATING CONCRETE FORMS MANUFACTURERS ASSOCIATION



**Table A.3.800. Above Grade Shear Wall Length for Seismic Zone Classification,  $S_{a,ICF} \leq 0.16$  and Hourly Wind Pressure,  $q_{1/50} \leq 0.5kPa$  (in a Building Without Walkout Basement), where Building Area  $\leq 800ft^2$**

| Wall Height m (ft)   | Seismic Zone Classification               |                                 |                                  |                                 |                                  |                                 |                                 |                                 |
|--|---|---------------------------------|----------------------------------|---------------------------------|----------------------------------|---------------------------------|---------------------------------|---------------------------------|
|  | $S_{a,ICF} \leq 0.07$                     |                                 | $S_{a,ICF} \leq 0.11$            |                                 | $S_{a,ICF} \leq 0.16$            |                                 |                                 |                                 |
| <b>Second Floor Walls of Two Story ICF Structure Supporting Wood Frame Roof (TYPE A)</b>                       |   |                                 |                                  |                                 |                                  |                                 |                                 |                                 |
|  | 6" & 8" Thick Wall                        |                                 | 10" & 12" Thick Wall             |                                 | 6" & 8" Thick Wall               |                                 | 10" & 12" Thick Wall            |                                 |
|  | Number and length of shear walls provided |                                 |                                  |                                 |                                  |                                 |                                 |                                 |
| 2.44 (8)   | 1 x 5'-2" 2 x 2'-8"                       | --                              | 1 x 5'-2" 2 x 2'-8"              | --                              | 1 x 5'-2" 2 x 2'-8"              | --                              | 1 x 5'-2" 2 x 2'-8"             | --                              |
| 2.75 (9)   | 1 x 5'-2" 2 x 2'-8"                       | --                              | 1 x 5'-2" 2 x 2'-8"              | --                              | 1 x 5'-2" 2 x 2'-8"              | --                              | 1 x 5'-2" 2 x 2'-8"             | --                              |
| 3.05 (10)  | 1 x 5'-2" 2 x 2'-8"                       | --                              | 1 x 5'-2" 2 x 2'-8"              | --                              | 1 x 5'-2" 2 x 2'-8"              | --                              | 1 x 5'-2" 2 x 2'-11" 3 x 2'-8"  | 1 x 5'-2" 2 x 3'-3" 3 x 2'-8"   |
| <b>Main Floor Walls of One Story ICF Structure Supporting Wood Frame Roof (TYPE B)</b>                         |   |                                 |                                  |                                 |                                  |                                 |                                 |                                 |
|  | 6" & 8" Thick Wall                        |                                 | 10" & 12" Thick Wall             |                                 | 6" & 8" Thick Wall               |                                 | 10" & 12" Thick Wall            |                                 |
|  | Number and length of shear walls provided |                                 |                                  |                                 |                                  |                                 |                                 |                                 |
| 2.44 (8)   | 1 x 5'-2" 2 x 2'-8"                       | --                              | 1 x 5'-2" 2 x 2'-8"              | --                              | 1 x 5'-2" 2 x 2'-8"              | --                              | 1 x 5'-2" 2 x 2'-8"             | --                              |
| 2.75 (9)   | 1 x 5'-2" 2 x 2'-8"                       | --                              | 1 x 5'-2" 2 x 2'-8"              | --                              | 1 x 5'-2" 2 x 2'-8"              | --                              | 1 x 5'-2" 2 x 2'-8"             | --                              |
| 3.05 (10)  | 1 x 5'-2" 2 x 2'-8"                       | --                              | 1 x 5'-2" 2 x 2'-8"              | --                              | 1 x 5'-2" 2 x 2'-8"              | --                              | 1 x 5'-2" 2 x 2'-11" 3 x 2'-8"  | 1 x 5'-2" 2 x 3'-3" 3 x 2'-8"   |
| 3.66 (12)  | 1 x 5'-2" 2 x 2'-8"                       | --                              | 1 x 5'-2" 2 x 2'-8"              | --                              | 1 x 5'-2" 2 x 2'-11" 3 x 2'-8"   | 1 x 5'-2" 2 x 2'-11" 3 x 2'-8"  | 1 x 5'-10" 2 x 3'-7" 3 x 2'-11" | 1 x 5'-10" 2 x 3'-7" 3 x 2'-11" |
| 4.27 (14)  | 1 x 5'-2" 2 x 2'-8"                       | --                              | 1 x 5'-2" 2 x 2'-8"              | --                              | 1 x 5'-2" 2 x 3'-3" 3 x 2'-8"    | 1 x 5'-2" 2 x 3'-3" 3 x 2'-8"   | 1 x 6'-1" 2 x 3'-11" 3 x 3'-3"  | 1 x 6'-6" 2 x 4'-7" 3 x 3'-7"   |
| 4.88 (16)  | 1 x 5'-2" 2 x 2'-8"                       | --                              | 1 x 5'-2" 2 x 3'-3" 3 x 2'-8"    | 1 x 5'-2" 2 x 3'-3" 3 x 2'-8"   | 1 x 5'-10" 2 x 3'-11" 3 x 2'-11" | 1 x 6'-6" 2 x 4'-3" 3 x 3'-3"   | 1 x 7'-2" 2 x 4'-11" 3 x 3'-11" | 1 x 7'-2" 2 x 4'-11" 3 x 3'-11" |
| <b>Main Floor Walls of Two Story Structure Supporting 2nd Story Wood Framed Walls, Floor and Roof (TYPE C)</b> |   |                                 |                                  |                                 |                                  |                                 |                                 |                                 |
|  | 6" & 8" Thick Wall                        |                                 | 10" & 12" Thick Wall             |                                 | 6" & 8" Thick Wall               |                                 | 10" & 12" Thick Wall            |                                 |
|  | Number and length of shear walls provided |                                 |                                  |                                 |                                  |                                 |                                 |                                 |
| 2.44 (8)   | 1 x 5'-2" 2 x 2'-8"                       | --                              | 1 x 5'-2" 2 x 2'-8"              | --                              | 1 x 5'-10" 2 x 3'-11" 3 x 3'-3"  | 1 x 5'-10" 2 x 4'-3" 3 x 3'-3"  | 1 x 7'-2" 2 x 4'-7" 3 x 3'-7"   | 1 x 7'-6" 2 x 4'-7" 3 x 3'-7"   |
| 2.75 (9)   | 1 x 5'-2" 2 x 2'-11" 3 x 2'-8"            | 1 x 5'-2" 2 x 2'-11" 3 x 2'-8"  | 1 x 5'-10" 2 x 4'-3" 3 x 3'-3"   | 1 x 6'-6" 2 x 4'-7" 3 x 3'-3"   | 1 x 7'-10" 2 x 4'-11" 3 x 3'-11" | 1 x 8'-5" 2 x 5'-2" 3 x 3'-11"  | 1 x 9'-9" 2 x 6'-2" 3 x 5'-2"   | 1 x 10'-5" 2 x 7'-2" 3 x 5'-2"  |
| 3.05 (10)  | 1 x 5'-2" 2 x 3'-3" 3 x 2'-8"             | 1 x 5'-2" 2 x 3'-3" 3 x 2'-8"   | 1 x 6'-2" 2 x 4'-9" 3 x 3'-11"   | 1 x 6'-6" 2 x 4'-9" 3 x 3'-11"  | 1 x 7'-10" 2 x 5'-2" 3 x 4'-3"   | 1 x 8'-5" 2 x 5'-10" 3 x 4'-7"  | 1 x 10'-1" 2 x 7'-2" 3 x 5'-10" | 1 x 11'-1" 2 x 7'-2" 3 x 5'-10" |
| 3.66 (12)  | 1 x 5'-6" 2 x 3'-7" 3 x 2'-8"             | 1 x 5'-6" 2 x 3'-7" 3 x 2'-8"   | 1 x 6'-10" 2 x 5'-5" 3 x 4'-3"   | 1 x 6'-10" 2 x 5'-5" 3 x 4'-3"  | 1 x 8'-9" 2 x 5'-10" 3 x 4'-7"   | 1 x 10'-5" 2 x 7'-2" 3 x 5'-10" | 1 x 11'-1" 2 x 7'-2" 3 x 5'-10" | 1 x 11'-1" 2 x 7'-2" 3 x 5'-10" |
| 4.27 (14)  | 1 x 5'-6" 2 x 3'-7" 3 x 2'-11"            | 1 x 5'-6" 2 x 3'-11" 3 x 2'-11" | 1 x 7'-2" 2 x 5'-6" 3 x 4'-7"    | 1 x 7'-6" 2 x 5'-10" 3 x 4'-7"  | 1 x 8'-5" 2 x 5'-10" 3 x 4'-7"   | 1 x 10'-5" 2 x 7'-2" 3 x 5'-10" | 1 x 11'-8" 2 x 7'-10" 3 x 6'-6" | 1 x 11'-8" 2 x 7'-10" 3 x 6'-6" |
| 4.88 (16)  | 1 x 5'-6" 2 x 3'-7" 3 x 2'-11"            | 1 x 5'-10" 2 x 3'-11" 3 x 3'-3" | 1 x 7'-2" 2 x 5'-10" 3 x 4'-11"  | 1 x 7'-10" 2 x 6'-2" 3 x 4'-11" | 1 x 8'-5" 2 x 5'-10" 3 x 4'-11"  | 1 x 10'-5" 2 x 7'-2" 3 x 5'-10" | 1 x 11'-8" 2 x 8'-2" 3 x 6'-6"  | 1 x 11'-8" 2 x 8'-2" 3 x 6'-6"  |
| <b>Main Floor Walls of Two Story ICF Structure Supporting Wood Frame Floors and Roof (TYPE D)</b>              |   |                                 |                                  |                                 |                                  |                                 |                                 |                                 |
|  | 6" & 8" Thick Wall                        |                                 | 10" & 12" Thick Wall             |                                 | 6" & 8" Thick Wall               |                                 | 10" & 12" Thick Wall            |                                 |
|  | Number and length of shear walls provided |                                 |                                  |                                 |                                  |                                 |                                 |                                 |
| 2.44 (8)   | 1 x 5'-10" 2 x 3'-7" 3 x 2'-8"            | 1 x 5'-10" 2 x 3'-7" 3 x 2'-11" | 1 x 7'-2" 2 x 4'-7" 3 x 3'-7"    | 1 x 7'-10" 2 x 5'-2" 3 x 3'-11" | 1 x 9'-1" 2 x 5'-10" 3 x 4'-7"   | 1 x 10'-5" 2 x 6'-6" 3 x 5'-2"  | 1 x 10'-5" 2 x 6'-6" 3 x 5'-2"  |                                 |
| 2.75 (9)   | 1 x 5'-10" 2 x 3'-11" 3 x 2'-8"           | 1 x 6'-6" 2 x 3'-11" 3 x 3'-3"  | 1 x 7'-10" 2 x 4'-11" 3 x 3'-11" | 1 x 8'-5" 2 x 5'-2" 3 x 3'-11"  | 1 x 9'-9" 2 x 6'-2" 3 x 5'-2"    | 1 x 10'-5" 2 x 7'-2" 3 x 5'-2"  | 1 x 10'-5" 2 x 7'-2" 3 x 5'-2"  |                                 |
| 3.05 (10)  | 1 x 6'-2" 2 x 3'-11" 3 x 2'-11"           | 1 x 6'-6" 2 x 4'-3" 3 x 3'-3"   | 1 x 8'-5" 2 x 5'-2" 3 x 3'-11"   | 1 x 8'-5" 2 x 5'-6" 3 x 4'-7"   | 1 x 10'-1" 2 x 6'-6" 3 x 5'-2"   | 1 x 11'-1" 2 x 7'-2" 3 x 5'-6"  | 1 x 11'-1" 2 x 7'-2" 3 x 5'-6"  |                                 |
| 3.66 (12)  | 1 x 6'-6" 2 x 4'-7" 3 x 3'-3"             | 1 x 6'-6" 2 x 4'-7" 3 x 3'-3"   | 1 x 8'-5" 2 x 5'-10" 3 x 4'-7"   | 1 x 8'-9" 2 x 5'-10" 3 x 4'-7"  | 1 x 10'-5" 2 x 7'-2" 3 x 5'-10"  | 1 x 11'-1" 2 x 7'-2" 3 x 5'-10" | 1 x 11'-1" 2 x 7'-2" 3 x 5'-10" |                                 |
| 4.27 (14)  | 1 x 6'-6" 2 x 4'-7" 3 x 3'-7"             | 1 x 7'-2" 2 x 4'-11" 3 x 3'-11" | 1 x 8'-5" 2 x 5'-10" 3 x 4'-7"   | 1 x 8'-5" 2 x 5'-10" 3 x 4'-7"  | 1 x 9'-5" 2 x 6'-2" 3 x 5'-2"    | 1 x 10'-5" 2 x 7'-2" 3 x 5'-10" | 1 x 11'-8" 2 x 7'-10" 3 x 6'-6" |                                 |
| 4.88 (16)  | 1 x 6'-6" 2 x 4'-7" 3 x 3'-7"             | 1 x 7'-6" 2 x 4'-11" 3 x 3'-11" | 1 x 8'-5" 2 x 5'-10" 3 x 4'-7"   | 1 x 8'-5" 2 x 5'-10" 3 x 4'-7"  | 1 x 9'-5" 2 x 6'-6" 3 x 5'-2"    | 1 x 10'-5" 2 x 7'-2" 3 x 5'-10" | 1 x 11'-8" 2 x 8'-2" 3 x 6'-6"  |                                 |
| Vertical Reinforcement   | ICF with 6" Tie Spacing                   | As per table A.1.1.             |                                  |                                 | As per table A.1.1.              |                                 |                                 | As per table A.1.1.             |
| Vertical Reinforcement   | ICF with 8" Tie Spacing                   | As per table A.1.2.             |                                  |                                 | As per table A.1.2.              |                                 |                                 | As per table A.1.2.             |
| Horizontal Reinforcement   | Block Height of 12" and 18"               | 10 M @ 450 (18)                 | 10 M @ 450 (18)                  |                                 |                                  | 10 M @ 450 (18)                 |                                 |                                 |
| Horizontal Reinforcement   | Block Height of 16"                       | 10 M @ 400 (16)                 | 10 M @ 400 (16)                  |                                 |                                  | 10 M @ 400 (16)                 |                                 |                                 |

**NOTES:**

1.  $S_{a,ICF}$  is equivalent spectral response acceleration for ICF walls as provided in Appendix A.
2. This table is to be used in conjunction with the "Design Limitations."
3. Provide two layers of the indicated horizontal and vertical distributed steel specified for 300mm (12") walls. Place each layer as shown in the rebar placement drawing.
4. All four sides of the building are to have a minimum number and length of shear walls that conforms to this table.
5. Use Table A.6 for buildings that do not meet the required wall length of this table.
6. Provide 2-15M concentrated reinforcement at each end of shear walls as shown in shear wall detail.
7. All concentrated reinforcement is to be continued to the bottom of the foundation wall. Provide lap splices as required.
8. Concentrated reinforcement is to be placed in accordance with Bar Placement Detail.

**INSULATING CONCRETE FORMS MANUFACTURERS ASSOCIATION**



**Table A.4.800. Above Grade Shear Wall Length for Seismic Zone Classification,  $S_{a,ICF} \leq 0.16$  and Hourly Wind Pressure,  $0.5kPa < q1/50 \leq 0.75kPa$  (in a Building Without Walkout Basement), where Building Area  $\leq 800ft^2$**

| Wall Height m (ft)   | Seismic Zone Classification               |                     |                       |            |                       |            |
|--|---|---------------------|-----------------------|------------|-----------------------|------------|
|  | $S_{a,ICF} \leq 0.07$                     |                     | $S_{a,ICF} \leq 0.11$ |            | $S_{a,ICF} \leq 0.16$ |            |
| <b>Second Floor Walls of Two Story ICF Structure Supporting Wood Frame Roof (TYPE A)</b>                       |   |                     |                       |            |                       |            |
|  | 6" & 8" Thick Wall                        |                     | 10" & 12" Thick Wall  |            | 6" & 8" Thick Wall    |            |
|  | Number and length of shear walls provided |                     |                       |            |                       |            |
| 2.44 (8)   | 1 x 5'-2" 2 x 2'-8"                       | --                  | 1 x 5'-2" 2 x 2'-8"   | --         | 1 x 5'-2" 2 x 2'-8"   | --         |
| 2.75 (9)   | 1 x 5'-2" 2 x 2'-8"                       | --                  | 1 x 5'-2" 2 x 2'-8"   | --         | 1 x 5'-2" 2 x 2'-8"   | --         |
| 3.05 (10)  | 1 x 5'-2" 2 x 2'-8"                       | --                  | 1 x 5'-2" 2 x 2'-8"   | --         | 1 x 5'-2" 2 x 2'-8"   | --         |
| 4.27 (14)  | 1 x 5'-2" 2 x 2'-8"                       | --                  | 1 x 5'-2" 2 x 2'-11"  | 3 x 2'-8"  | 1 x 5'-10" 2 x 3'-11" | 3 x 2'-11" |
| 4.88 (16)  | 1 x 5'-2" 2 x 2'-8"                       | --                  | 1 x 5'-2" 2 x 3'-3"   | 3 x 2'-8"  | 1 x 5'-10" 2 x 3'-11" | 3 x 2'-11" |
| <b>Main Floor Walls of One Story ICF Structure Supporting Wood Frame Roof (TYPE B)</b>                         |   |                     |                       |            |                       |            |
|  | 6" & 8" Thick Wall                        |                     | 10" & 12" Thick Wall  |            | 6" & 8" Thick Wall    |            |
|  | Number and length of shear walls provided |                     |                       |            |                       |            |
| 2.44 (8)   | 1 x 5'-2" 2 x 2'-8"                       | --                  | 1 x 5'-2" 2 x 2'-8"   | --         | 1 x 5'-2" 2 x 2'-8"   | --         |
| 2.75 (9)   | 1 x 5'-2" 2 x 2'-8"                       | --                  | 1 x 5'-2" 2 x 2'-8"   | --         | 1 x 5'-2" 2 x 2'-8"   | --         |
| 3.05 (10)  | 1 x 5'-2" 2 x 2'-8"                       | --                  | 1 x 5'-2" 2 x 2'-8"   | --         | 1 x 5'-2" 2 x 3'-3"   | 3 x 2'-8"  |
| 3.66 (12)  | 1 x 5'-2" 2 x 2'-8"                       | --                  | 1 x 5'-2" 2 x 2'-8"   | --         | 1 x 5'-2" 2 x 3'-3"   | 3 x 2'-8"  |
| 4.27 (14)  | 1 x 5'-2" 2 x 2'-8"                       | --                  | 1 x 5'-2" 2 x 2'-8"   | --         | 1 x 5'-2" 2 x 3'-3"   | 3 x 2'-8"  |
| 4.88 (16)  | 1 x 5'-2" 2 x 2'-8"                       | --                  | 1 x 5'-2" 2 x 3'-3"   | 3 x 2'-8"  | 1 x 5'-10" 2 x 3'-11" | 3 x 2'-11" |
| <b>Main Floor Walls of Two Story Structure Supporting 2nd Story Wood Framed Walls, Floor and Roof (TYPE C)</b> |   |                     |                       |            |                       |            |
|  | 6" & 8" Thick Wall                        |                     | 10" & 12" Thick Wall  |            | 6" & 8" Thick Wall    |            |
|  | Number and length of shear walls provided |                     |                       |            |                       |            |
| 2.44 (8)   | 1 x 5'-2" 2 x 2'-11"                      | 3 x 2'-8"           | 1 x 5'-2" 2 x 2'-8"   | --         | 1 x 5'-10" 2 x 3'-11" | 3 x 3'-3"  |
| 2.75 (9)   | 1 x 5'-2" 2 x 2'-11"                      | 3 x 2'-8"           | 1 x 5'-2" 2 x 2'-11"  | 3 x 2'-8"  | 1 x 5'-10" 2 x 4'-3"  | 3 x 3'-3"  |
| 3.05 (10)  | 1 x 5'-2" 2 x 3'-3"                       | 3 x 2'-8"           | 1 x 5'-2" 2 x 3'-3"   | 3 x 2'-8"  | 1 x 6'-6" 2 x 4'-9"   | 3 x 3'-11" |
| 3.66 (12)  | 1 x 5'-6" 2 x 3'-7"                       | 3 x 2'-8"           | 1 x 5'-6" 2 x 3'-7"   | 3 x 2'-8"  | 1 x 6'-10" 2 x 5'-5"  | 3 x 4'-3"  |
| 4.27 (14)  | 1 x 5'-6" 2 x 3'-7"                       | 3 x 2'-11"          | 1 x 5'-6" 2 x 3'-11"  | 3 x 2'-11" | 1 x 7'-2" 2 x 5'-6"   | 3 x 4'-7"  |
| 4.88 (16)  | 1 x 5'-6" 2 x 3'-7"                       | 3 x 2'-11"          | 1 x 5'-10" 2 x 3'-11" | 3 x 3'-3"  | 1 x 7'-2" 2 x 5'-10"  | 3 x 4'-11" |
| <b>Main Floor Walls of Two Story ICF Structure Supporting Wood Frame Floors and Roof (TYPE D)</b>              |   |                     |                       |            |                       |            |
|  | 6" & 8" Thick Wall                        |                     | 10" & 12" Thick Wall  |            | 6" & 8" Thick Wall    |            |
|  | Number and length of shear walls provided |                     |                       |            |                       |            |
| 2.44 (8)   | 1 x 5'-10" 2 x 3'-7"                      | 3 x 2'-11"          | 1 x 5'-10" 2 x 3'-7"  | 3 x 2'-11" | 1 x 7'-10" 2 x 5'-2"  | 3 x 3'-11" |
| 2.75 (9)   | 1 x 5'-10" 2 x 3'-11"                     | 3 x 2'-11"          | 1 x 6'-6" 2 x 3'-11"  | 3 x 3'-3"  | 1 x 7'-10" 2 x 4'-11" | 3 x 3'-11" |
| 3.05 (10)  | 1 x 6'-2" 2 x 4'-3"                       | 3 x 3'-3"           | 1 x 6'-6" 2 x 4'-3"   | 3 x 3'-3"  | 1 x 8'-5" 2 x 5'-6"   | 3 x 4'-7"  |
| 3.66 (12)  | 1 x 6'-6" 2 x 4'-7"                       | 3 x 3'-3"           | 1 x 6'-10" 2 x 4'-7"  | 3 x 3'-7"  | 1 x 8'-5" 2 x 5'-10"  | 3 x 4'-7"  |
| 4.27 (14)  | 1 x 6'-6" 2 x 4'-7"                       | 3 x 3'-7"           | 1 x 7'-2" 2 x 4'-11"  | 3 x 3'-11" | 1 x 8'-5" 2 x 5'-10"  | 3 x 4'-7"  |
| 4.88 (16)  | 1 x 6'-6" 2 x 4'-7"                       | 3 x 3'-7"           | 1 x 7'-6" 2 x 4'-11"  | 3 x 3'-11" | 1 x 8'-5" 2 x 5'-10"  | 3 x 4'-7"  |
| Vertical Reinforcement   | ICF with 6" Tie Spacing                   | As per table A.1.1. |                       |            | As per table A.1.1.   |            |
|  | ICF with 8" Tie Spacing                   | As per table A.1.2. |                       |            | As per table A.1.2.   |            |
| Horizontal Reinforcement   | Block Height of 12" and 18"               | 10 M @ 450 (18)     | 10 M @ 450 (18)       |            | 10 M @ 450 (18)       |            |
|  | Block Height of 16"                       | 10 M @ 400 (16)     | 10 M @ 400 (16)       |            | 10 M @ 400 (16)       |            |

**NOTES:**

1.  $S_{a,ICF}$  is equivalent spectral response acceleration for ICF walls as provided in Appendix A.
2. This table is to be used in conjunction with the "Design Limitations."
3. Provide two layers of the indicated horizontal and vertical distributed steel specified for 300mm (12") walls. Place each layer as shown in the rebar placement drawing.
4. All four sides of the building are to have a minimum number and length of shear walls that conforms to this table.
5. Use Table A.6 for buildings that do not meet the required wall length of this table.
6. Provide 2-15M concentrated reinforcement at each end of shear walls as shown in shear wall detail.
7. All concentrated reinforcement is to be continues to the bottom of the foundation wall. Provide lap splices as required.
8. Concentrated reinforcement is to be placed in accordance with Bar Placement Detail.

INSULATING CONCRETE FORMS MANUFACTURERS ASSOCIATION



**Table A.5.800. Above Grade Shear Wall Length for Seismic Zone Classification,  $S_{a,ICF} \leq 0.16$  and Hourly Wind Pressure,  $0.5kPa < q1/50 \leq 0.75kPa$  (in a Building Without Walkout Basement), where Building Area  $\leq 800ft^2$**

| Wall Height m (ft)   | Seismic Zone Classification               |                                 |                                  |                                 |                                 |                                  |
|--|---|---------------------------------|----------------------------------|---------------------------------|---------------------------------|----------------------------------|
|  | $S_{a,ICF} \leq 0.07$                     |                                 | $S_{a,ICF} \leq 0.11$            |                                 | $S_{a,ICF} \leq 0.16$           |                                  |
| <b>Second Floor Walls of Two Story ICF Structure Supporting Wood Frame Roof (TYPE A)</b>                       |   |                                 |                                  |                                 |                                 |                                  |
|  | 6" & 8" Thick Wall                        |                                 | 10" & 12" Thick Wall             |                                 | 6" & 8" Thick Wall              |                                  |
|  | Number and length of shear walls provided |                                 |                                  |                                 |                                 |                                  |
| 2.44 (8)   | 1 x 5'-2" 2 x 2'-8"                       | --                              | 1 x 5'-2" 2 x 2'-8"              | --                              | 1 x 5'-2" 2 x 2'-8"             | --                               |
| 2.75 (9)   | 1 x 5'-2" 2 x 2'-8"                       | --                              | 1 x 5'-2" 2 x 2'-8"              | --                              | 1 x 5'-2" 2 x 2'-8"             | --                               |
| 3.05 (10)  | 1 x 5'-2" 2 x 2'-8"                       | --                              | 1 x 5'-2" 2 x 2'-8"              | --                              | 1 x 5'-2" 2 x 2'-8"             | --                               |
| <b>Main Floor Walls of One Story ICF Structure Supporting Wood Frame Roof (TYPE B)</b>                         |   |                                 |                                  |                                 |                                 |                                  |
|  | 6" & 8" Thick Wall                        |                                 | 10" & 12" Thick Wall             |                                 | 6" & 8" Thick Wall              |                                  |
|  | Number and length of shear walls provided |                                 |                                  |                                 |                                 |                                  |
| 2.44 (8)   | 1 x 5'-2" 2 x 2'-8"                       | --                              | 1 x 5'-2" 2 x 2'-8"              | --                              | 1 x 5'-2" 2 x 2'-8"             | --                               |
| 2.75 (9)   | 1 x 5'-2" 2 x 2'-8"                       | --                              | 1 x 5'-2" 2 x 2'-8"              | --                              | 1 x 5'-2" 2 x 2'-8"             | --                               |
| 3.05 (10)  | 1 x 5'-2" 2 x 2'-8"                       | --                              | 1 x 5'-2" 2 x 2'-8"              | --                              | 1 x 5'-2" 2 x 2'-8"             | --                               |
| 3.66 (12)  | 1 x 5'-2" 2 x 2'-8"                       | --                              | 1 x 5'-2" 2 x 2'-8"              | --                              | 1 x 5'-2" 2 x 2'-8"             | --                               |
| 4.27 (14)  | 1 x 5'-2" 2 x 2'-8"                       | --                              | 1 x 5'-2" 2 x 2'-8"              | --                              | 1 x 5'-2" 2 x 2'-8"             | --                               |
| 4.88 (16)  | 1 x 5'-2" 2 x 2'-8"                       | --                              | 1 x 5'-2" 2 x 2'-8"              | --                              | 1 x 5'-2" 2 x 2'-8"             | --                               |
| <b>Main Floor Walls of Two Story Structure Supporting 2nd Story Wood Framed Walls, Floor and Roof (TYPE C)</b> |   |                                 |                                  |                                 |                                 |                                  |
|  | 6" & 8" Thick Wall                        |                                 | 10" & 12" Thick Wall             |                                 | 6" & 8" Thick Wall              |                                  |
|  | Number and length of shear walls provided |                                 |                                  |                                 |                                 |                                  |
| 2.44 (8)   | 1 x 5'-2" 2 x 2'-11" 3 x 2'-8"            | 1 x 5'-2" 2 x 2'-8"             | --                               | 1 x 5'-10" 2 x 3'-11" 3 x 3'-3" | 1 x 5'-10" 2 x 4'-3" 3 x 3'-3"  | 1 x 7'-6" 2 x 4'-11" 3 x 3'-11"  |
| 2.75 (9)   | 1 x 5'-2" 2 x 2'-11" 3 x 2'-8"            | 1 x 5'-2" 2 x 3'-3"             | 3 x 2'-8"                        | 1 x 5'-10" 2 x 4'-3" 3 x 3'-3"  | 1 x 6'-6" 2 x 4'-7" 3 x 3'-3"   | 1 x 7'-10" 2 x 4'-11" 3 x 3'-11" |
| 3.05 (10)  | 1 x 5'-2" 2 x 3'-3" 3 x 2'-8"             | 1 x 5'-2" 2 x 3'-3" 3 x 2'-8"   | 1 x 6'-6" 2 x 4'-9" 3 x 3'-11"   | 1 x 6'-6" 2 x 4'-9" 3 x 3'-11"  | 1 x 8'-2" 2 x 5'-6" 3 x 4'-3"   | 1 x 8'-2" 2 x 5'-2" 3 x 4'-3"    |
| 3.66 (12)  | 1 x 5'-6" 2 x 3'-7" 3 x 2'-8"             | 1 x 5'-6" 2 x 3'-7" 3 x 2'-8"   | 1 x 6'-10" 2 x 5'-5" 3 x 4'-3"   | 1 x 6'-10" 2 x 5'-5" 3 x 4'-3"  | 1 x 8'-5" 2 x 5'-10" 3 x 4'-7"  | 1 x 8'-5" 2 x 5'-10" 3 x 4'-7"   |
| 4.27 (14)  | 1 x 5'-6" 2 x 3'-7" 3 x 2'-11"            | 1 x 5'-6" 2 x 3'-11" 3 x 2'-11" | 1 x 7'-2" 2 x 5'-6" 3 x 4'-7"    | 1 x 7'-2" 2 x 5'-6" 3 x 4'-7"   | 1 x 8'-5" 2 x 5'-10" 3 x 4'-7"  | 1 x 9'-1" 2 x 6'-6" 3 x 4'-11"   |
| 4.88 (16)  | 1 x 5'-6" 2 x 3'-7" 3 x 2'-11"            | 1 x 5'-10" 2 x 3'-11" 3 x 3'-3" | 1 x 7'-2" 2 x 5'-10" 3 x 4'-11"  | 1 x 7'-10" 2 x 6'-2" 3 x 4'-11" | 1 x 8'-5" 2 x 5'-10" 3 x 4'-11" | 1 x 9'-5" 2 x 6'-6" 3 x 4'-11"   |
| <b>Main Floor Walls of Two Story ICF Structure Supporting Wood Frame Floors and Roof (TYPE D)</b>              |   |                                 |                                  |                                 |                                 |                                  |
|  | 6" & 8" Thick Wall                        |                                 | 10" & 12" Thick Wall             |                                 | 6" & 8" Thick Wall              |                                  |
|  | Number and length of shear walls provided |                                 |                                  |                                 |                                 |                                  |
| 2.44 (8)   | 1 x 5'-10" 2 x 3'-7" 3 x 2'-11"           | 1 x 5'-10" 2 x 3'-7" 3 x 2'-11" | 1 x 7'-2" 2 x 4'-11" 3 x 3'-11"  | 1 x 7'-10" 2 x 5'-2" 3 x 3'-11" | 1 x 9'-1" 2 x 5'-10" 3 x 4'-7"  | 1 x 10'-5" 2 x 6'-6" 3 x 5'-2"   |
| 2.75 (9)   | 1 x 5'-10" 2 x 3'-11" 3 x 2'-11"          | 1 x 6'-6" 2 x 4'-3" 3 x 3'-3"   | 1 x 7'-10" 2 x 4'-11" 3 x 3'-11" | 1 x 8'-5" 2 x 5'-6" 3 x 4'-3"   | 1 x 9'-9" 2 x 6'-2" 3 x 5'-2"   | 1 x 10'-5" 2 x 7'-2" 3 x 5'-2"   |
| 3.05 (10)  | 1 x 6'-2" 2 x 4'-3" 3 x 3'-3"             | 1 x 6'-6" 2 x 4'-3" 3 x 3'-3"   | 1 x 8'-5" 2 x 5'-6" 3 x 4'-3"    | 1 x 8'-5" 2 x 5'-6" 3 x 4'-7"   | 1 x 10'-1" 2 x 6'-10" 3 x 5'-2" | 1 x 11'-1" 2 x 7'-2" 3 x 5'-6"   |
| 3.66 (12)  | 1 x 6'-6" 2 x 4'-7" 3 x 3'-3"             | 1 x 6'-10" 2 x 4'-7" 3 x 3'-7"  | 1 x 8'-5" 2 x 5'-10" 3 x 4'-7"   | 1 x 8'-9" 2 x 5'-10" 3 x 4'-7"  | 1 x 10'-5" 2 x 7'-2" 3 x 5'-10" | 1 x 11'-1" 2 x 7'-2" 3 x 5'-10"  |
| 4.27 (14)  | 1 x 6'-6" 2 x 4'-7" 3 x 3'-7"             | 1 x 7'-2" 2 x 4'-11" 3 x 3'-11" | 1 x 8'-5" 2 x 5'-10" 3 x 4'-7"   | 1 x 9'-5" 2 x 6'-2" 3 x 5'-2"   | 1 x 10'-5" 2 x 7'-2" 3 x 5'-10" | 1 x 11'-8" 2 x 7'-10" 3 x 6'-6"  |
| 4.88 (16)  | 1 x 6'-6" 2 x 4'-7" 3 x 3'-7"             | 1 x 7'-6" 2 x 4'-11" 3 x 3'-11" | 1 x 8'-5" 2 x 5'-10" 3 x 4'-7"   | 1 x 9'-5" 2 x 6'-6" 3 x 5'-2"   | 1 x 10'-5" 2 x 7'-2" 3 x 5'-10" | 1 x 11'-8" 2 x 8'-2" 3 x 6'-6"   |
| Vertical Reinforcement   | ICF with 6" Tie Spacing                   | As per table A.1.1.             |                                  | As per table A.1.1.             |                                 | As per table A.1.1.              |
|  | ICF with 8" Tie Spacing                   | As per table A.1.2.             |                                  | As per table A.1.2.             |                                 | As per table A.1.2.              |
| Horizontal Reinforcement   | Block Height of 12" and 18"               | 10 M @ 450 (18)                 |                                  | 10 M @ 450 (18)                 |                                 | 10 M @ 450 (18)                  |
|  | Block Height of 16"                       | 10 M @ 400 (16)                 |                                  | 10 M @ 400 (16)                 |                                 | 10 M @ 400 (16)                  |

**NOTES:**

1.  $S_{a,ICF}$  is equivalent spectral response acceleration for ICF walls as provided in Appendix A.
2. This table is to be used in conjunction with the "Design Limitations."
3. Provide two layers of the indicated horizontal and vertical distributed steel specified for 300mm (12") walls. Place each layer as shown in the rebar placement drawing.
4. All four sides of the building are to have a minimum number and length of shear walls that conforms to this table.
5. Use Table A.6 for buildings that do not meet the required wall length of this table.
6. Provide 2-15M concentrated reinforcement at each end of shear walls as shown in shear wall detail.
7. All concentrated reinforcement is to be continues to the bottom of the foundation wall. Provide lap splices as required.
8. Concentrated reinforcement is to be placed in accordance with Bar Placement Detail.

INSULATING CONCRETE FORMS MANUFACTURERS ASSOCIATION



**Table A.6.800. Above Grade Shear Wall Length for Seismic Zone Classification,  $S_{a,ICF} > 0.16$  and Hourly Wind Pressure,  $q_{1/50} \leq 1.05kPa$  (in a Building Without Walkout Basement), where Building Area  $\leq 800ft^2$**

| Wall Height m (ft)   | Seismic Zone Classification               |                     |                       |                     |                       |                     |                       |                     |
|--|---|---------------------|-----------------------|---------------------|-----------------------|---------------------|-----------------------|---------------------|
|  | $S_{a,ICF} \leq 0.16$                     |                     | $S_{a,ICF} \leq 0.31$ |                     | $S_{a,ICF} \leq 0.53$ |                     | $S_{a,ICF} \leq 0.79$ |                     |
| <b>Second Floor Walls of Two Story ICF Structure Supporting Wood Frame Roof (TYPE A)</b>                       |   |                     |                       |                     |                       |                     |                       |                     |
|  | 6" & 8" Thick Wall                        |                     | 10" & 12" Thick Wall  |                     | 6" & 8" Thick Wall    |                     | 10" & 12" Thick Wall  |                     |
|  | Number and length of shear walls provided |                     |                       |                     |                       |                     |                       |                     |
| 2.44 (8)   | 1x5'-2"                                   | 2x2'-8"             | 1x5'-2"               | 2x2'-8"             | 1x5'-2"               | 2x4'-0"             | 1x5'-2"               | 2x4'-0"             |
| 2.75 (9)   | 1x5'-2"                                   | 2x2'-8"             | 1x5'-2"               | 2x2'-8"             | 1x5'-2"               | 2x4'-0"             | 1x5'-2"               | 2x4'-0"             |
| 3.05 (10)  | 1x5'-2"                                   | 2x3'-3"             | 1x5'-2"               | 2x3'-3"             | 1x5'-2"               | 2x5'-0"             | 1x5'-2"               | 2x5'-0"             |
| 3.66 (12)  | 1x5'-2"                                   | 2x3'-3"             | 1x5'-2"               | 2x3'-3"             | 1x5'-2"               | 2x6'-0"             | 1x5'-2"               | 2x6'-0"             |
| 4.27 (14)  | 1x5'-2"                                   | 2x3'-3"             | 1x5'-2"               | 2x3'-3"             | 1x5'-2"               | 2x7'-0"             | 1x5'-2"               | 2x7'-0"             |
| 4.88 (16)  | 1x5'-2"                                   | 2x3'-3"             | 1x5'-2"               | 2x3'-3"             | 1x5'-2"               | 2x8'-0"             | 1x5'-2"               | 2x8'-0"             |
| <b>Main Floor Walls of One Story ICF Structure Supporting Wood Frame Roof (TYPE B)</b>                         |   |                     |                       |                     |                       |                     |                       |                     |
|  | 6" & 8" Thick Wall                        |                     | 10" & 12" Thick Wall  |                     | 6" & 8" Thick Wall    |                     | 10" & 12" Thick Wall  |                     |
|  | Number and length of shear walls provided |                     |                       |                     |                       |                     |                       |                     |
| 2.44 (8)   | 1x5'-2"                                   | 2x2'-8"             | 1x5'-2"               | 2x2'-8"             | 1x5'-2"               | 2x4'-0"             | 1x5'-2"               | 2x4'-0"             |
| 2.75 (9)   | 1x5'-2"                                   | 2x2'-8"             | 1x5'-2"               | 2x2'-8"             | 1x5'-2"               | 2x4'-0"             | 1x5'-2"               | 2x4'-0"             |
| 3.05 (10)  | 1x5'-2"                                   | 2x3'-3"             | 1x5'-2"               | 2x3'-3"             | 1x5'-2"               | 2x5'-0"             | 1x5'-2"               | 2x5'-0"             |
| 3.66 (12)  | 1x5'-2"                                   | 2x3'-3"             | 1x5'-2"               | 2x3'-3"             | 1x5'-2"               | 2x6'-0"             | 1x5'-2"               | 2x6'-0"             |
| 4.27 (14)  | 1x5'-2"                                   | 2x3'-3"             | 1x5'-2"               | 2x3'-3"             | 1x5'-2"               | 2x7'-0"             | 1x5'-2"               | 2x7'-0"             |
| 4.88 (16)  | 1x5'-2"                                   | 2x3'-3"             | 1x5'-2"               | 2x3'-3"             | 1x5'-2"               | 2x8'-0"             | 1x5'-2"               | 2x8'-0"             |
| <b>Main Floor Walls of Two Story Structure Supporting 2nd Story Wood Framed Walls, Floor and Roof (TYPE C)</b> |   |                     |                       |                     |                       |                     |                       |                     |
|  | 6" & 8" Thick Wall                        |                     | 10" & 12" Thick Wall  |                     | 6" & 8" Thick Wall    |                     | 10" & 12" Thick Wall  |                     |
|  | Number and length of shear walls provided |                     |                       |                     |                       |                     |                       |                     |
| 2.44 (8)   | 1x5'-10"                                  | 2x3'-11"            | 1x5'-10"              | 2x3'-11"            | 1x5'-10"              | 2x5'-10"            | 1x5'-10"              | 2x5'-10"            |
| 2.75 (9)   | 1x5'-10"                                  | 2x3'-11"            | 1x5'-10"              | 2x3'-11"            | 1x5'-10"              | 2x5'-10"            | 1x5'-10"              | 2x5'-10"            |
| 3.05 (10)  | 1x6'-6"                                   | 2x4'-3"             | 1x6'-6"               | 2x4'-3"             | 1x6'-6"               | 2x6'-6"             | 1x6'-6"               | 2x6'-6"             |
| 3.66 (12)  | 1x6'-6"                                   | 2x4'-3"             | 1x6'-6"               | 2x4'-3"             | 1x6'-6"               | 2x6'-6"             | 1x6'-6"               | 2x6'-6"             |
| 4.27 (14)  | 1x6'-6"                                   | 2x4'-3"             | 1x6'-6"               | 2x4'-3"             | 1x6'-6"               | 2x7'-10"            | 1x6'-6"               | 2x7'-10"            |
| 4.88 (16)  | 1x6'-6"                                   | 2x4'-3"             | 1x6'-6"               | 2x4'-3"             | 1x6'-6"               | 2x8'-0"             | 1x6'-6"               | 2x8'-0"             |
| <b>Main Floor Walls of Two Story ICF Structure Supporting Wood Frame Floors and Roof (TYPE D)</b>              |   |                     |                       |                     |                       |                     |                       |                     |
|  | 6" & 8" Thick Wall                        |                     | 10" & 12" Thick Wall  |                     | 6" & 8" Thick Wall    |                     | 10" & 12" Thick Wall  |                     |
|  | Number and length of shear walls provided |                     |                       |                     |                       |                     |                       |                     |
| 2.44 (8)   | 1x7'-2"                                   | 2x4'-11"            | 1x7'-10"              | 2x4'-11"            | 1x10'-5"              | 2x7'-2"             | 1x11'-1"              | 2x7'-2"             |
| 2.75 (9)   | 1x7'-10"                                  | 2x5'-2"             | 1x7'-10"              | 2x5'-2"             | 1x11'-1"              | 2x7'-2"             | 1x11'-1"              | 2x7'-2"             |
| 3.05 (10)  | 1x7'-10"                                  | 2x5'-2"             | 1x7'-10"              | 2x5'-2"             | 1x11'-1"              | 2x7'-2"             | 1x11'-1"              | 2x7'-2"             |
| 3.66 (12)  | 1x7'-10"                                  | 2x5'-6"             | 1x7'-10"              | 2x5'-6"             | 1x11'-1"              | 2x7'-10"            | 1x11'-1"              | 2x7'-10"            |
| 4.27 (14)  | 1x7'-10"                                  | 2x5'-6"             | 1x7'-10"              | 2x5'-6"             | 1x11'-1"              | 2x8'-5"             | 1x11'-1"              | 2x8'-5"             |
| 4.88 (16)  | 1x7'-10"                                  | 2x5'-10"            | 1x7'-10"              | 2x5'-10"            | 1x11'-1"              | 2x8'-5"             | 1x11'-1"              | 2x8'-5"             |
| Vertical Reinforcement   | ICF with 6" The Spec'ing                  | As per table A.2.1. | As per table A.2.1.   | As per table A.2.1. | As per table A.2.1.   | As per table A.2.1. | As per table A.2.1.   | As per table A.2.1. |
| Horizontal Reinforcement   | Block Height of 12" and 18"               | As per table A.2.1. | As per table A.2.1.   | As per table A.2.1. | As per table A.2.1.   | As per table A.2.1. | As per table A.2.1.   | As per table A.2.1. |
|  | Block Height of 16"                       | As per table A.2.2. | As per table A.2.2.   | As per table A.2.2. | As per table A.2.2.   | As per table A.2.2. | As per table A.2.2.   | As per table A.2.2. |

**NOTES:**

- $S_{a,ICF}$  is equivalent spectral response acceleration for ICF walls as provided in Appendix A.
- This table is to be used in conjunction with the "Design Limitations."
- Provide two layers of the indicated horizontal and vertical distributed steel specified for 300mm (12") walls. Place each layer as shown in the rebar placement drawing.
- All four sides of the building are to have a minimum number and length of shear walls that conforms to this table.
- Provide 2-15M concentrated reinforcement at each end of shear walls as shown in shear wall detail.
- All concentrated reinforcement is to be continues to the bottom of the foundation wall. Provide lap splices as required.
- Concentrated reinforcement is to be placed in accordance with Bar Placement Detail.
- Horizontal reinforcement in shear walls where  $S_{a,ICF} > 0.16$  must be anchored using a standard 180° hook around vertical end bars.
- When using this table for  $S_{a,ICF} \leq 0.16$ , use the vertical and horizontal distributed steel in Tables A.2.1. or A.2.2.

INSULATING CONCRETE FORMS MANUFACTURERS ASSOCIATION



**Table A.7.800. Above Grade Shear Wall Length for Seismic Zone Classification,  $S_{a,ICF} \leq 0.16$  and Hourly Wind Pressure,  $q_{1/50} \leq 0.5kPa$  (in a Building With Walk Basement), where Building Area  $\leq 800ft^2$**

| Wall Height m (ft)   | Seismic Zone Classification               |                     |                       |                 |                       |                     |                      |                 |            |                     |            |                 |             |            |            |            |            |            |
|--|---|---------------------|-----------------------|-----------------|-----------------------|---------------------|----------------------|-----------------|------------|---------------------|------------|-----------------|-------------|------------|------------|------------|------------|------------|
|  | $S_{a,ICF} \leq 0.07$                     |                     | $S_{a,ICF} \leq 0.11$ |                 | $S_{a,ICF} \leq 0.16$ |                     |                      |                 |            |                     |            |                 |             |            |            |            |            |            |
| <b>Second Floor Walls of Two Story ICF Structure Supporting Wood Frame Roof (TYPE E)</b>                       |   |                     |                       |                 |                       |                     |                      |                 |            |                     |            |                 |             |            |            |            |            |            |
|  | 6" & 8" Thick Wall                        |                     | 10" & 12" Thick Wall  |                 | 6" & 8" Thick Wall    |                     | 10" & 12" Thick Wall |                 |            |                     |            |                 |             |            |            |            |            |            |
|  | Number and length of shear walls provided |                     |                       |                 |                       |                     |                      |                 |            |                     |            |                 |             |            |            |            |            |            |
| 2.44 (8)   | 1 x 5'-2"                                 | 2 x 2'-8"           | --                    | 1 x 5'-2"       | 2 x 2'-8"             | --                  | 1 x 5'-2"            | 2 x 2'-8"       | --         | 1 x 5'-2"           | 2 x 2'-11" | 3 x 2'-8"       | 1 x 5'-2"   | 2 x 3'-3"  | 3 x 2'-8"  |            |            |            |
| 2.75 (9)   | 1 x 5'-2"                                 | 2 x 2'-8"           | --                    | 1 x 5'-2"       | 2 x 2'-8"             | --                  | 1 x 5'-2"            | 2 x 2'-8"       | --         | 1 x 5'-2"           | 2 x 2'-10" | 3 x 2'-8"       | 1 x 5'-6"   | 2 x 3'-6"  | 3 x 2'-10" |            |            |            |
| 3.05 (10)  | 1 x 5'-2"                                 | 2 x 2'-8"           | --                    | 1 x 5'-2"       | 2 x 2'-8"             | --                  | 1 x 5'-2"            | 2 x 2'-11"      | 3 x 2'-8"  | 1 x 5'-2"           | 2 x 2'-11" | 3 x 2'-8"       | 1 x 5'-6"   | 2 x 3'-7"  | 3 x 2'-10" |            |            |            |
| 3.66 (12)  | 1 x 5'-2"                                 | 2 x 2'-8"           | --                    | 1 x 5'-2"       | 2 x 2'-8"             | --                  | 1 x 5'-6"            | 2 x 3'-7"       | 3 x 2'-10" | 1 x 5'-6"           | 2 x 3'-7"  | 3 x 2'-10"      | 1 x 6'-10"  | 2 x 4'-7"  | 3 x 3'-7"  |            |            |            |
| 4.27 (14)  | 1 x 5'-2"                                 | 2 x 2'-11"          | 3 x 2'-8"             | 1 x 5'-2"       | 2 x 3'-3"             | 3 x 2'-8"           | 1 x 6'-6"            | 2 x 3'-11"      | 3 x 3'-0"  | 1 x 6'-10"          | 2 x 4'-7"  | 3 x 3'-6"       | 1 x 7'-6"   | 2 x 4'-11" | 3 x 3'-11" |            |            |            |
| 4.88 (16)  | 1 x 5'-2"                                 | 2 x 3'-3"           | 3 x 2'-8"             | 1 x 5'-10"      | 2 x 3'-7"             | 3 x 2'-11"          | 1 x 6'-6"            | 2 x 4'-3"       | 3 x 3'-3"  | 1 x 7'-2"           | 2 x 4'-11" | 3 x 3'-8"       | 1 x 7'-10"  | 2 x 5'-2"  | 3 x 4'-3"  |            |            |            |
| <b>Main Floor Walls of One Story ICF Structure Supporting Wood Frame Roof (TYPE F)</b>                         |   |                     |                       |                 |                       |                     |                      |                 |            |                     |            |                 |             |            |            |            |            |            |
|  | 6" & 8" Thick Wall                        |                     | 10" & 12" Thick Wall  |                 | 6" & 8" Thick Wall    |                     | 10" & 12" Thick Wall |                 |            |                     |            |                 |             |            |            |            |            |            |
|  | Number and length of shear walls provided |                     |                       |                 |                       |                     |                      |                 |            |                     |            |                 |             |            |            |            |            |            |
| 2.44 (8)   | 1 x 5'-2"                                 | 2 x 2'-8"           | --                    | 1 x 5'-2"       | 2 x 2'-8"             | --                  | 1 x 5'-2"            | 2 x 2'-8"       | --         | 1 x 5'-2"           | 2 x 2'-8"  | --              | 1 x 5'-2"   | 2 x 2'-11" | 3 x 2'-8"  |            |            |            |
| 2.75 (9)   | 1 x 5'-2"                                 | 2 x 2'-8"           | --                    | 1 x 5'-2"       | 2 x 2'-8"             | --                  | 1 x 5'-2"            | 2 x 2'-8"       | --         | 1 x 5'-2"           | 2 x 2'-11" | 3 x 2'-8"       | 1 x 5'-6"   | 2 x 3'-3"  | 3 x 2'-8"  |            |            |            |
| 3.05 (10)  | 1 x 5'-2"                                 | 2 x 2'-8"           | --                    | 1 x 5'-2"       | 2 x 2'-8"             | --                  | 1 x 5'-2"            | 2 x 2'-11"      | 3 x 2'-8"  | 1 x 5'-2"           | 2 x 2'-11" | 3 x 2'-8"       | 1 x 5'-6"   | 2 x 3'-8"  | 3 x 2'-10" |            |            |            |
| 3.66 (12)  | 1 x 5'-2"                                 | 2 x 2'-8"           | --                    | 1 x 5'-2"       | 2 x 2'-8"             | --                  | 1 x 5'-6"            | 2 x 3'-7"       | 3 x 2'-10" | 1 x 5'-6"           | 2 x 3'-7"  | 3 x 2'-10"      | 1 x 6'-10"  | 2 x 4'-7"  | 3 x 3'-7"  |            |            |            |
| 4.27 (14)  | 1 x 5'-2"                                 | 2 x 2'-11"          | 3 x 2'-8"             | 1 x 5'-2"       | 2 x 3'-3"             | 3 x 2'-8"           | 1 x 6'-6"            | 2 x 3'-11"      | 3 x 3'-0"  | 1 x 6'-10"          | 2 x 4'-7"  | 3 x 3'-6"       | 1 x 7'-6"   | 2 x 4'-11" | 3 x 3'-11" |            |            |            |
| 4.88 (16)  | 1 x 5'-2"                                 | 2 x 3'-3"           | 3 x 2'-8"             | 1 x 5'-10"      | 2 x 3'-7"             | 3 x 2'-11"          | 1 x 6'-6"            | 2 x 4'-3"       | 3 x 3'-3"  | 1 x 7'-2"           | 2 x 4'-11" | 3 x 3'-8"       | 1 x 7'-10"  | 2 x 5'-2"  | 3 x 4'-3"  |            |            |            |
| <b>Main Floor Walls of Two Story Structure Supporting 2nd Story Wood Framed Walls, Floor and Roof (TYPE G)</b> |   |                     |                       |                 |                       |                     |                      |                 |            |                     |            |                 |             |            |            |            |            |            |
|  | 6" & 8" Thick Wall                        |                     | 10" & 12" Thick Wall  |                 | 6" & 8" Thick Wall    |                     | 10" & 12" Thick Wall |                 |            |                     |            |                 |             |            |            |            |            |            |
|  | Number and length of shear walls provided |                     |                       |                 |                       |                     |                      |                 |            |                     |            |                 |             |            |            |            |            |            |
| 2.44 (8)   | 1 x 5'-2"                                 | 2 x 3'-3"           | 3 x 2'-8"             | 1 x 5'-2"       | 2 x 3'-3"             | 3 x 2'-8"           | 1 x 6'-6"            | 2 x 3'-11"      | 3 x 3'-3"  | 1 x 6'-6"           | 2 x 4'-3"  | 3 x 3'-3"       | 1 x 8'-2"   | 2 x 5'-2"  | 3 x 3'-11" | 1 x 8'-5"  | 2 x 5'-2"  | 3 x 4'-3"  |
| 2.75 (9)   | 1 x 5'-2"                                 | 2 x 3'-3"           | 3 x 2'-8"             | 1 x 5'-2"       | 2 x 3'-3"             | 3 x 2'-8"           | 1 x 6'-10"           | 2 x 4'-3"       | 3 x 3'-3"  | 1 x 7'-2"           | 2 x 4'-7"  | 3 x 3'-3"       | 1 x 7'-2"   | 2 x 4'-7"  | 3 x 3'-3"  | 1 x 8'-11" | 2 x 5'-10" | 3 x 4'-7"  |
| 3.05 (10)  | 1 x 5'-6"                                 | 2 x 3'-7"           | 3 x 2'-10"            | 1 x 5'-6"       | 2 x 3'-7"             | 3 x 2'-10"          | 1 x 7'-6"            | 2 x 4'-9"       | 3 x 3'-11" | 1 x 7'-6"           | 2 x 4'-9"  | 3 x 3'-11"      | 1 x 9'-1"   | 2 x 5'-10" | 3 x 4'-7"  | 1 x 9'-5"  | 2 x 6'-1"  | 3 x 4'-9"  |
| 3.66 (12)  | 1 x 6'-1"                                 | 2 x 4'-1"           | 3 x 3'-3"             | 1 x 6'-1"       | 2 x 4'-1"             | 3 x 3'-3"           | 1 x 8'-0"            | 2 x 5'-5"       | 3 x 4'-3"  | 1 x 8'-0"           | 2 x 5'-5"  | 3 x 4'-3"       | 1 x 9'-9"   | 2 x 6'-9"  | 3 x 5'-2"  | 1 x 9'-9"  | 2 x 6'-9"  | 3 x 5'-2"  |
| 4.27 (14)  | 1 x 6'-3"                                 | 2 x 4'-3"           | 3 x 3'-6"             | 1 x 6'-9"       | 2 x 4'-7"             | 3 x 3'-6"           | 1 x 8'-3"            | 2 x 5'-6"       | 3 x 4'-7"  | 1 x 8'-9"           | 2 x 5'-10" | 3 x 4'-7"       | 1 x 10'-1"  | 2 x 6'-10" | 3 x 5'-6"  | 1 x 10'-7" | 2 x 7'-4"  | 3 x 5'-10" |
| 4.88 (16)  | 1 x 6'-6"                                 | 2 x 4'-7"           | 3 x 3'-7"             | 1 x 7'-2"       | 2 x 4'-9"             | 3 x 3'-8"           | 1 x 8'-5"            | 2 x 5'-10"      | 3 x 4'-11" | 1 x 9'-1"           | 2 x 6'-2"  | 3 x 4'-11"      | 1 x 10'-1"  | 2 x 6'-10" | 3 x 5'-6"  | 1 x 11'-1" | 2 x 7'-6"  | 3 x 6'-1"  |
| <b>Main Floor Walls of Two Story ICF Structure Supporting Wood Frame Floors and Roof (TYPE H)</b>              |   |                     |                       |                 |                       |                     |                      |                 |            |                     |            |                 |             |            |            |            |            |            |
|  | 6" & 8" Thick Wall                        |                     | 10" & 12" Thick Wall  |                 | 6" & 8" Thick Wall    |                     | 10" & 12" Thick Wall |                 |            |                     |            |                 |             |            |            |            |            |            |
|  | Number and length of shear walls provided |                     |                       |                 |                       |                     |                      |                 |            |                     |            |                 |             |            |            |            |            |            |
| 2.44 (8)   | 1 x 6'-1"                                 | 2 x 3'-11"          | 3 x 2'-11"            | 1 x 6'-6"       | 2 x 4'-1"             | 3 x 3'-3"           | 1 x 8'-2"            | 2 x 5'-2"       | 3 x 3'-11" | 1 x 8'-8"           | 2 x 5'-6"  | 3 x 4'-3"       | 1 x 10'-5"  | 2 x 6'-6"  | 3 x 5'-2"  | 1 x 10'-9" | 2 x 7'-2"  | 3 x 5'-6"  |
| 2.75 (9)   | 1 x 6'-3"                                 | 2 x 4'-3"           | 3 x 3'-0"             | 1 x 7'-2"       | 2 x 4'-3"             | 3 x 3'-3"           | 1 x 8'-5"            | 2 x 5'-5"       | 3 x 4'-3"  | 1 x 9'-1"           | 2 x 5'-10" | 3 x 4'-7"       | 1 x 10'-9"  | 2 x 7'-2"  | 3 x 5'-6"  | 1 x 11'-5" | 2 x 7'-6"  | 3 x 5'-10" |
| 3.05 (10)  | 1 x 6'-9"                                 | 2 x 4'-3"           | 3 x 3'-3"             | 1 x 7'-2"       | 2 x 4'-7"             | 3 x 3'-7"           | 1 x 8'-11"           | 2 x 5'-10"      | 3 x 4'-7"  | 1 x 9'-9"           | 2 x 6'-2"  | 3 x 4'-11"      | 1 x 11'-5"  | 2 x 7'-6"  | 3 x 5'-10" | 1 x 12'-0" | 2 x 7'-10" | 3 x 6'-2"  |
| 3.66 (12)  | 1 x 7'-6"                                 | 2 x 4'-11"          | 3 x 3'-11"            | 1 x 7'-6"       | 2 x 4'-11"            | 3 x 3'-11"          | 1 x 9'-5"            | 2 x 6'-6"       | 3 x 4'-12" | 1 x 9'-9"           | 2 x 6'-6"  | 3 x 4'-12"      | 1 x 11'-8"  | 2 x 8'-0"  | 3 x 6'-3"  | 1 x 12'-4" | 2 x 8'-0"  | 3 x 6'-3"  |
| 4.27 (14)  | 1 x 7'-6"                                 | 2 x 5'-2"           | 3 x 4'-3"             | 1 x 8'-2"       | 2 x 5'-6"             | 3 x 4'-7"           | 1 x 9'-9"            | 2 x 6'-6"       | 3 x 5'-2"  | 1 x 10'-9"          | 2 x 7'-2"  | 3 x 5'-10"      | 1 x 11'-11" | 2 x 8'-2"  | 3 x 6'-6"  | 1 x 13'-8" | 2 x 8'-9"  | 3 x 7'-2"  |
| 4.88 (16)  | 1 x 7'-6"                                 | 2 x 5'-2"           | 3 x 4'-3"             | 1 x 8'-5"       | 2 x 5'-10"            | 3 x 4'-7"           | 1 x 9'-9"            | 2 x 6'-6"       | 3 x 5'-2"  | 1 x 11'-5"          | 2 x 7'-10" | 3 x 5'-10"      | 1 x 11'-11" | 2 x 8'-2"  | 3 x 6'-6"  | 1 x 13'-8" | 2 x 9'-4"  | 3 x 7'-4"  |
| Vertical Reinforcement   | ICF with 6" Tie Spacing                   | As per table A.1.1. |                       |                 |                       | As per table A.1.1. |                      |                 |            | As per table A.1.1. |            |                 |             |            |            |            |            |            |
| Vertical Reinforcement   | ICF with 8" Tie Spacing                   | As per table A.1.2. |                       |                 |                       | As per table A.1.2. |                      |                 |            | As per table A.1.2. |            |                 |             |            |            |            |            |            |
| Horizontal Reinforcement   | Block Height of 12" and 18"               | 10 M @ 450 (18)     |                       | 10 M @ 450 (18) |                       | 10 M @ 450 (18)     |                      | 10 M @ 450 (18) |            | 10 M @ 450 (18)     |            | 10 M @ 450 (18) |             |            |            |            |            |            |
| Horizontal Reinforcement   | Block Height of 16"                       | 10 M @ 400 (16)     |                       | 10 M @ 400 (16) |                       | 10 M @ 400 (16)     |                      | 10 M @ 400 (16) |            | 10 M @ 400 (16)     |            | 10 M @ 400 (16) |             |            |            |            |            |            |

**NOTES:**

1.  $S_{a,ICF}$  is equivalent spectral response acceleration for ICF walls as provided in Appendix A.
2. This table is to be used in conjunction with the "Design Limitations."
3. Provide two layers of the indicated horizontal and vertical distributed steel specified for 300mm (12") walls. Place each layer as shown in the rebar placement drawing.
4. All four sides of the building are to have a minimum number and length of shear walls that conforms to this table.
5. Use Table A.6 for buildings that do not meet the required wall length of this table.
6. Provide 2-15M concentrated reinforcement at each end of shear walls as shown in shear wall detail.
7. All concentrated reinforcement is to be continues to the bottom of the foundation wall. Provide lap splices as required.
8. Concentrated reinforcement is to be placed in accordance with Bar Placement Detail.

INSULATING CONCRETE FORMS MANUFACTURERS ASSOCIATION



**Table A.8.800. Above Grade Shear Wall Length for Seismic Zone Classification,  $S_{a,ICF} \leq 0.16$  and Hourly Wind Pressure,  $0.5kPa < q1/50 \leq 0.75kPa$  (in a Building With Walkout Basement), where Building Area  $\leq 800ft^2$**

| Wall Height m (ft)   | Seismic Zone Classification               |                     |                       |                     |                       |                     |
|--|---|---------------------|-----------------------|---------------------|-----------------------|---------------------|
|  | $S_{a,ICF} \leq 0.07$                     |                     | $S_{a,ICF} \leq 0.11$ |                     | $S_{a,ICF} \leq 0.16$ |                     |
| <b>Second Floor Walls of Two Story ICF Structure Supporting Wood Frame Roof (TYPE E)</b>                       |   |                     |                       |                     |                       |                     |
|  | 6" & 8" Thick Wall                        |                     | 10" & 12" Thick Wall  |                     | 10" & 12" Thick Wall  |                     |
|  | Number and length of shear walls provided |                     |                       |                     |                       |                     |
| 2.44 (8)   | 1 x 5'-2"                                 | 2 x 2'-8"           | --                    | 1 x 5'-2"           | 2 x 2'-8"             | --                  |
| 2.75 (9)   | 1 x 5'-2"                                 | 2 x 2'-8"           | --                    | 1 x 5'-2"           | 2 x 2'-8"             | --                  |
| 3.05 (10)  | 1 x 5'-2"                                 | 2 x 2'-8"           | --                    | 1 x 5'-2"           | 2 x 2'-8"             | --                  |
| <b>Main Floor Walls of One Story ICF Structure Supporting Wood Frame Roof (TYPE F)</b>                         |   |                     |                       |                     |                       |                     |
|  | 6" & 8" Thick Wall                        |                     | 10" & 12" Thick Wall  |                     | 10" & 12" Thick Wall  |                     |
|  | Number and length of shear walls provided |                     |                       |                     |                       |                     |
| 2.44 (8)   | 1 x 5'-2"                                 | 2 x 2'-8"           | --                    | 1 x 5'-2"           | 2 x 2'-8"             | --                  |
| 2.75 (9)   | 1 x 5'-2"                                 | 2 x 2'-8"           | --                    | 1 x 5'-2"           | 2 x 2'-8"             | --                  |
| 3.05 (10)  | 1 x 5'-2"                                 | 2 x 2'-8"           | --                    | 1 x 5'-2"           | 2 x 2'-8"             | --                  |
| 3.66 (12)  | 1 x 5'-2"                                 | 2 x 2'-8"           | --                    | 1 x 5'-2"           | 2 x 2'-8"             | --                  |
| 4.27 (14)  | 1 x 5'-2"                                 | 2 x 2'-11"          | 3 x 2'-8"             | 1 x 5'-2"           | 2 x 3'-3"             | 3 x 2'-8"           |
| 4.88 (16)  | 1 x 5'-2"                                 | 2 x 3'-3"           | 3 x 2'-8"             | 1 x 5'-10"          | 2 x 3'-7"             | 3 x 2'-11"          |
| <b>Main Floor Walls of Two Story Structure Supporting 2nd Story Wood Framed Walls, Floor and Roof (TYPE G)</b> |   |                     |                       |                     |                       |                     |
|  | 6" & 8" Thick Wall                        |                     | 10" & 12" Thick Wall  |                     | 10" & 12" Thick Wall  |                     |
|  | Number and length of shear walls provided |                     |                       |                     |                       |                     |
| 2.44 (8)   | 1 x 5'-2"                                 | 2 x 3'-3"           | 3 x 2'-8"             | 1 x 5'-2"           | 2 x 3'-3"             | 3 x 2'-8"           |
| 2.75 (9)   | 1 x 5'-2"                                 | 2 x 3'-3"           | 3 x 2'-8"             | 1 x 5'-2"           | 2 x 3'-3"             | 3 x 2'-8"           |
| 3.05 (10)  | 1 x 5'-2"                                 | 2 x 3'-3"           | 3 x 2'-8"             | 1 x 5'-2"           | 2 x 3'-3"             | 3 x 2'-8"           |
| 3.66 (12)  | 1 x 6'-1"                                 | 2 x 4'-1"           | 3 x 3'-3"             | 1 x 6'-1"           | 2 x 4'-1"             | 3 x 3'-3"           |
| 4.27 (14)  | 1 x 6'-3"                                 | 2 x 4'-3"           | 3 x 3'-6"             | 1 x 6'-3"           | 2 x 4'-3"             | 3 x 3'-6"           |
| 4.88 (16)  | 1 x 6'-6"                                 | 2 x 4'-7"           | 3 x 3'-7"             | 1 x 7'-2"           | 2 x 4'-9"             | 3 x 3'-8"           |
| <b>Main Floor Walls of Two Story ICF Structure Supporting Wood Frame Floors and Roof (TYPE H)</b>              |   |                     |                       |                     |                       |                     |
|  | 6" & 8" Thick Wall                        |                     | 10" & 12" Thick Wall  |                     | 10" & 12" Thick Wall  |                     |
|  | Number and length of shear walls provided |                     |                       |                     |                       |                     |
| 2.44 (8)   | 1 x 6'-1"                                 | 2 x 3'-11"          | 3 x 3'-0"             | 1 x 6'-6"           | 2 x 4'-1"             | 3 x 3'-3"           |
| 2.75 (9)   | 1 x 6'-3"                                 | 2 x 4'-3"           | 3 x 3'-0"             | 1 x 7'-2"           | 2 x 4'-3"             | 3 x 3'-3"           |
| 3.05 (10)  | 1 x 7'-2"                                 | 2 x 4'-7"           | 3 x 3'-7"             | 1 x 7'-2"           | 2 x 4'-7"             | 3 x 3'-7"           |
| 3.66 (12)  | 1 x 7'-6"                                 | 2 x 4'-11"          | 3 x 3'-11"            | 1 x 7'-6"           | 2 x 4'-11"            | 3 x 3'-11"          |
| 4.27 (14)  | 1 x 7'-6"                                 | 2 x 4'-11"          | 3 x 3'-11"            | 1 x 7'-6"           | 2 x 4'-11"            | 3 x 3'-11"          |
| 4.88 (16)  | 1 x 7'-6"                                 | 2 x 5'-2"           | 3 x 4'-3"             | 1 x 8'-0"           | 2 x 5'-5"             | 3 x 4'-3"           |
| <b>Vertical Reinforcement</b>  |   |                     |                       |                     |                       |                     |
|  | ICF with 6" Tie Spacing                   | As per table A.1.1. |                       | As per table A.1.1. |                       | As per table A.1.1. |
|  | ICF with 8" Tie Spacing                   | As per table A.1.2. |                       | As per table A.1.2. |                       | As per table A.1.2. |
| <b>Horizontal Reinforcement</b>  |   |                     |                       |                     |                       |                     |
|  | Block Height of 12" and 18"               | 10 M @ 450 (18)     |                       | 10 M @ 450 (18)     |                       | 10 M @ 450 (18)     |
|  | Block Height of 16"                       | 10 M @ 400 (16)     |                       | 10 M @ 400 (16)     |                       | 10 M @ 400 (16)     |

**NOTES:**

1.  $S_{a,ICF}$  is equivalent spectral response acceleration for ICF walls as provided in Appendix A.
2. This table is to be used in conjunction with the "Design Limitations."
3. Provide two layers of the indicated horizontal and vertical distributed steel specified for 300mm (12") walls. Place each layer as shown in the rebar placement drawing.
4. All four sides of the building are to have a minimum number and length of shear walls that conforms to this table.
5. Use Table A.6 for buildings that do not meet the required wall length of this table.
6. Provide 2-15M concentrated reinforcement at each end of shear walls as shown in shear wall detail.
7. All concentrated reinforcement is to be continues to the bottom of the foundation wall. Provide lap splices as required.
8. Concentrated reinforcement is to be placed in accordance with Bar Placement Detail.

INSULATING CONCRETE FORMS MANUFACTURERS ASSOCIATION





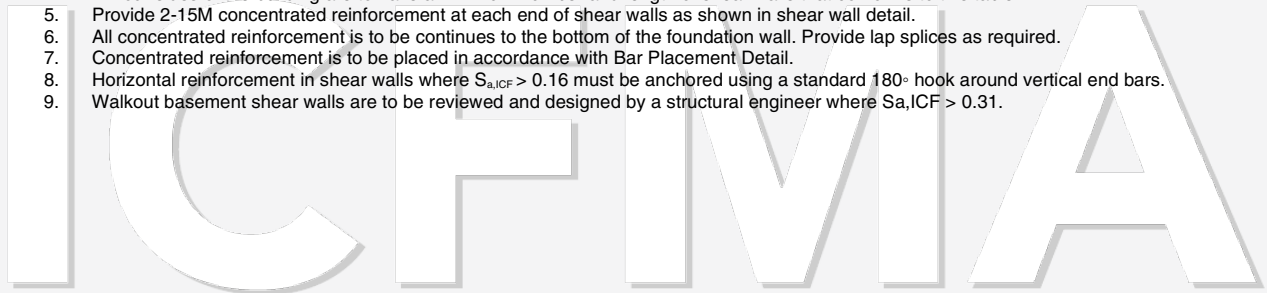

**Table A. 11.800. – Above Grade Walkout Basement Shear Wall Length for Seismic Zone Classification,  $S_{a,ICF} \leq 0.31$  and Hourly Wind Pressure,  $q/50 \leq 1.05kPa$ , where Building Area  $\leq 800ft^2$**

| Wall Height m (ft)  | Seismic Zone Classification               |                      |                       |                      |                       |                      |                       |                      |          |
|---|---|----------------------|-----------------------|----------------------|-----------------------|----------------------|-----------------------|----------------------|----------|
|   | $S_{a,ICF} \leq 0.07$                     |                      | $S_{a,ICF} \leq 0.11$ |                      | $S_{a,ICF} \leq 0.16$ |                      | $S_{a,ICF} \leq 0.31$ |                      |          |
| <b>Walkout Basement Wall of a Single Story ICF Structure Supporting Wood Framed Roof (TYPE W1)</b>  |   |                      |                       |                      |                       |                      |                       |                      |          |
|   | 6" & 8" Thick Wall                        | 10" & 12" Thick Wall | 6" & 8" Thick Wall    | 10" & 12" Thick Wall | 6" & 8" Thick Wall    | 10" & 12" Thick Wall | 6" & 8" Thick Wall    | 10" & 12" Thick Wall |          |
|   | Number and length of shear walls provided |                      |                       |                      |                       |                      |                       |                      |          |
| 2.44 (8)  | 1x5'-2"                                   | 2x3'-7"              | 3x2'-11"              | 1x5'-6"              | 2x3'-11"              | 3x2'-11"             | 1x6'-6"               | 2x4'-7"              | 3x3'-7"  |
| 2.75 (9)  | 1x5'-4"                                   | 2x3'-7"              | 3x2'-11"              | 1x5'-10"             | 2x3'-11"              | 3x3'-3"              | 1x6'-10"              | 2x4'-7"              | 3x3'-11" |
| 3.05 (10)   | 1x5'-6"                                   | 2x3'-11"             | 3x2'-11"              | 1x5'-10"             | 2x4'-3"               | 3x3'-3"              | 1x6'-10"              | 2x4'-11"             | 3x3'-11" |
| 3.66 (12)   | 1x6'-0"                                   | 2x4'-0"              | 3x3'-3"               | 1x6'-6"              | 2x4'-3"               | 3x3'-7"              | 1x7'-4"               | 2x5'-2"              | 3x4'-3"  |
| <b>Walkout Basement Walls of a Two Story Wood Framed Structure Supporting Wood Frame Floors and Roof (TYPE W2)</b>                              |   |                      |                       |                      |                       |                      |                       |                      |          |
|   | 6" & 8" Thick Wall                        | 10" & 12" Thick Wall | 6" & 8" Thick Wall    | 10" & 12" Thick Wall | 6" & 8" Thick Wall    | 10" & 12" Thick Wall | 6" & 8" Thick Wall    | 10" & 12" Thick Wall |          |
|   | Number and length of shear walls provided |                      |                       |                      |                       |                      |                       |                      |          |
| 2.44 (8)  | 1x6'-8"                                   | 2x4'-7"              | 3x3'-8"               | 1x6'-8"              | 2x4'-6"               | 3x3'-8"              | 1x6'-10"              | 2x4'-11"             | 3x3'-11" |
| 2.75 (9)  | 1x7'-0"                                   | 2x4'-8"              | 3x3'-8"               | 1x7'-0"              | 2x4'-8"               | 3x3'-8"              | 1x7'-2"               | 2x5'-2"              | 3x3'-11" |
| 3.05 (10)   | 1x7'-0"                                   | 2x4'-9"              | 3x4'-0"               | 1x7'-0"              | 2x4'-8"               | 3x3'-8"              | 1x7'-2"               | 2x5'-2"              | 3x3'-11" |
| 3.66 (12)   | 1x7'-4"                                   | 2x5'-0"              | 3x4'-0"               | 1x7'-4"              | 2x5'-0"               | 3x4'-0"              | 1x7'-6"               | 2x5'-2"              | 3x4'-3"  |
| <b>Walkout Basement Wall of a Two Story Building with Main Floor ICF Walls Supporting 2nd Story Wood Framed Walls, Floor and Roof (TYPE W3)</b> |   |                      |                       |                      |                       |                      |                       |                      |          |
|   | 6" & 8" Thick Wall                        | 10" & 12" Thick Wall | 6" & 8" Thick Wall    | 10" & 12" Thick Wall | 6" & 8" Thick Wall    | 10" & 12" Thick Wall | 6" & 8" Thick Wall    | 10" & 12" Thick Wall |          |
|   | Number and length of shear walls provided |                      |                       |                      |                       |                      |                       |                      |          |
| 2.44 (8)  | 1x6'-8"                                   | 2x4'-7"              | 3x3'-8"               | 1x6'-6"              | 2x4'-9"               | 3x3'-8"              | 1x8'-2"               | 2x5'-6"              | 3x4'-7"  |
| 2.75 (9)  | 1x7'-0"                                   | 2x4'-9"              | 3x3'-8"               | 1x6'-6"              | 2x4'-9"               | 3x3'-8"              | 1x8'-2"               | 2x5'-10"             | 3x4'-7"  |
| 3.05 (10)   | 1x7'-0"                                   | 2x4'-9"              | 3x4'-0"               | 1x6'-10"             | 2x4'-9"               | 3x4'-0"              | 1x8'-5"               | 2x5'-10"             | 3x4'-9"  |
| 3.66 (12)   | 1x7'-4"                                   | 2x5'-0"              | 3x4'-0"               | 1x7'-2"              | 2x4'-9"               | 3x4'-0"              | 1x8'-9"               | 2x6'-2"              | 3x4'-11" |
| <b>Walkout Basement Wall of Two Story ICF Structure Supporting Wood Frame Floors and Roof (TYPE W4)</b>   |   |                      |                       |                      |                       |                      |                       |                      |          |
|   | 6" & 8" Thick Wall                        | 10" & 12" Thick Wall | 6" & 8" Thick Wall    | 10" & 12" Thick Wall | 6" & 8" Thick Wall    | 10" & 12" Thick Wall | 6" & 8" Thick Wall    | 10" & 12" Thick Wall |          |
|   | Number and length of shear walls provided |                      |                       |                      |                       |                      |                       |                      |          |
| 2.44 (8)  | 1x7'-2"                                   | 2x4'-11"             | 3x4'-1"               | 1x7'-10"             | 2x5'-2"               | 3x4'-1"              | 1x9'-1"               | 2x6'-6"              | 3x5'-2"  |
| 2.75 (9)  | 1x7'-6"                                   | 2x5'-2"              | 3x4'-1"               | 1x7'-10"             | 2x5'-2"               | 3x4'-3"              | 1x9'-9"               | 2x6'-6"              | 3x5'-2"  |
| 3.05 (10)   | 1x7'-6"                                   | 2x5'-2"              | 3x4'-1"               | 1x7'-10"             | 2x5'-5"               | 3x4'-3"              | 1x9'-9"               | 2x6'-6"              | 3x5'-6"  |
| 3.66 (12)   | 1x7'-10"                                  | 2x5'-0"              | 3x4'-4"               | 1x8'-2"              | 2x5'-6"               | 3x4'-7"              | 1x10'-0"              | 2x6'-10"             | 3x5'-6"  |
| Vertical Reinforcement  | 6", 8" and 10" thick wall                 | 15 M @ 300 (12)      |                       | 10 M @ 300 (12)      |                       | 15 M @ 300 (12)      |                       | 10 M @ 300 (12)      |          |
| Horizontal Reinforcement  | Block Height of 12" and 18"               | 10 M @ 450 (18)      |                       | 10 M @ 450 (18)      |                       | 10 M @ 450 (18)      |                       | 10 M @ 450 (18)      |          |
|   | Block Height of 16"                       | 10 M @ 400 (16)      |                       | 10 M @ 400 (16)      |                       | 10 M @ 400 (16)      |                       | 10 M @ 400 (16)      |          |

**NOTES:**

1.  $S_{a,ICF}$  is equivalent spectral response acceleration for ICF walls as provided in Appendix A.
2. This table is to be used in conjunction with the "Design Limitations."
3. Provide two layers of the indicated horizontal and vertical distributed steel specified for 300mm (12") walls. Place each layer as shown in the rebar placement drawing.
4. All four sides of the building are to have a minimum number and length of shear walls that conforms to this table.
5. Provide 2-15M concentrated reinforcement at each end of shear walls as shown in shear wall detail.
6. All concentrated reinforcement is to be continues to the bottom of the foundation wall. Provide lap splices as required.
7. Concentrated reinforcement is to be placed in accordance with Bar Placement Detail.
8. Horizontal reinforcement in shear walls where  $S_{a,ICF} > 0.16$  must be anchored using a standard 180° hook around vertical end bars.
9. Walkout basement shear walls are to be reviewed and designed by a structural engineer where  $S_{a,ICF} > 0.31$ .



# INSULATING CONCRETE FORMS MANUFACTURERS ASSOCIATION



# Lintel Details and Tables

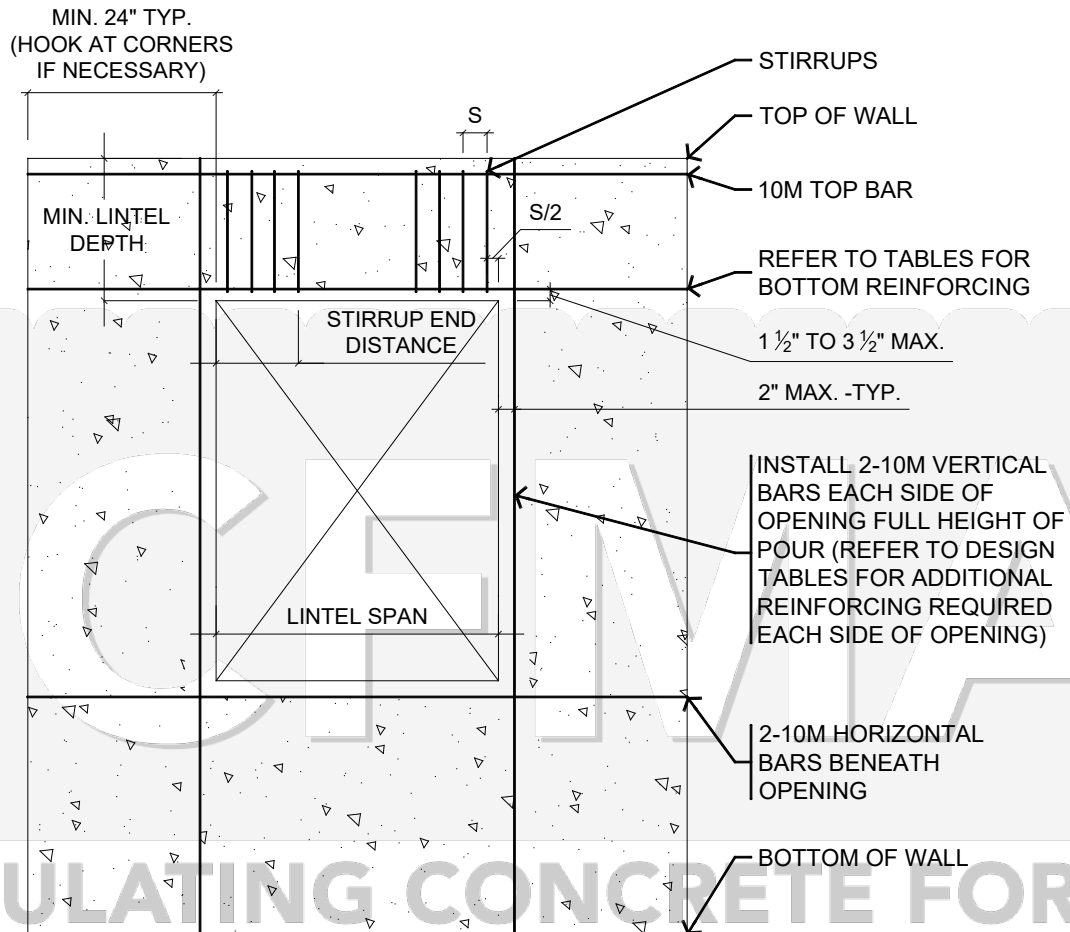

**Detail L. 1. Reinforcing Around Openings.**

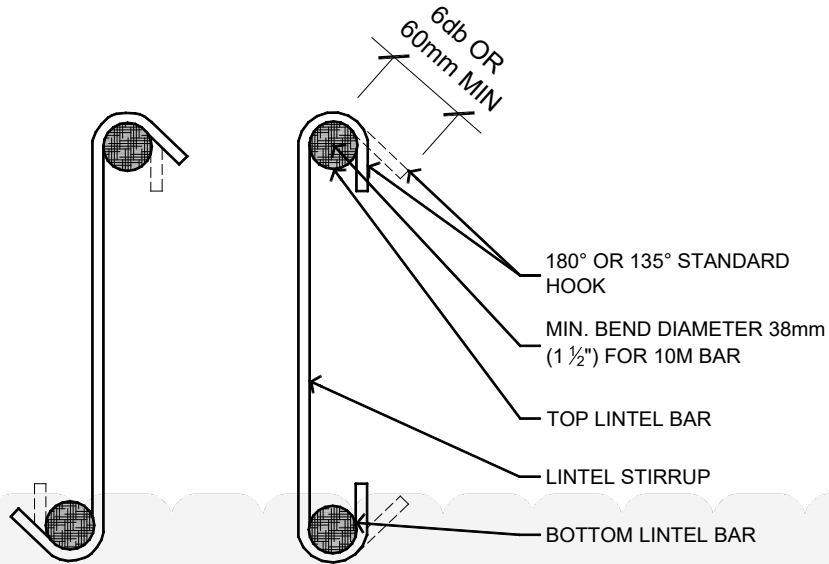

STIRRUP HOOKS IN  
OPPOSITE DIRECTION

STIRRUP HOOKS IN  
SAME DIRECTION

**Detail L. 2. Lintel Stirrup Detail.**

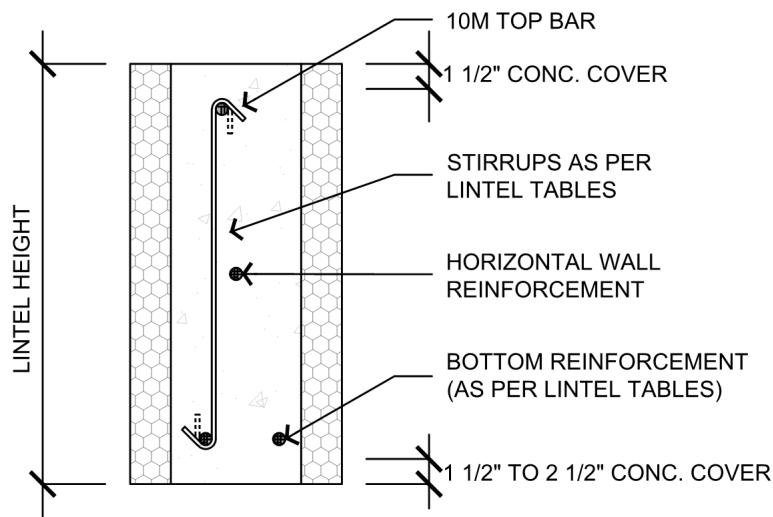

**Detail L. 3. Lintel Section**

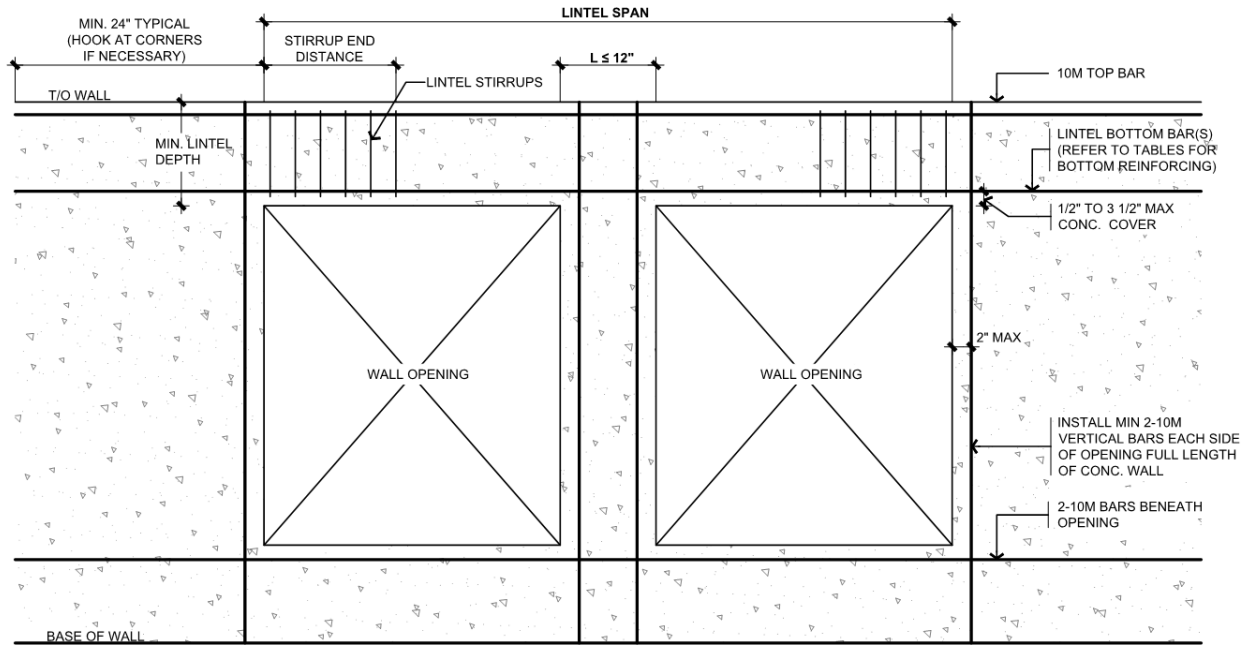

**Detail L. 4. Lintel Span with Less Than 305mm (12") of Wall Between Openings.**

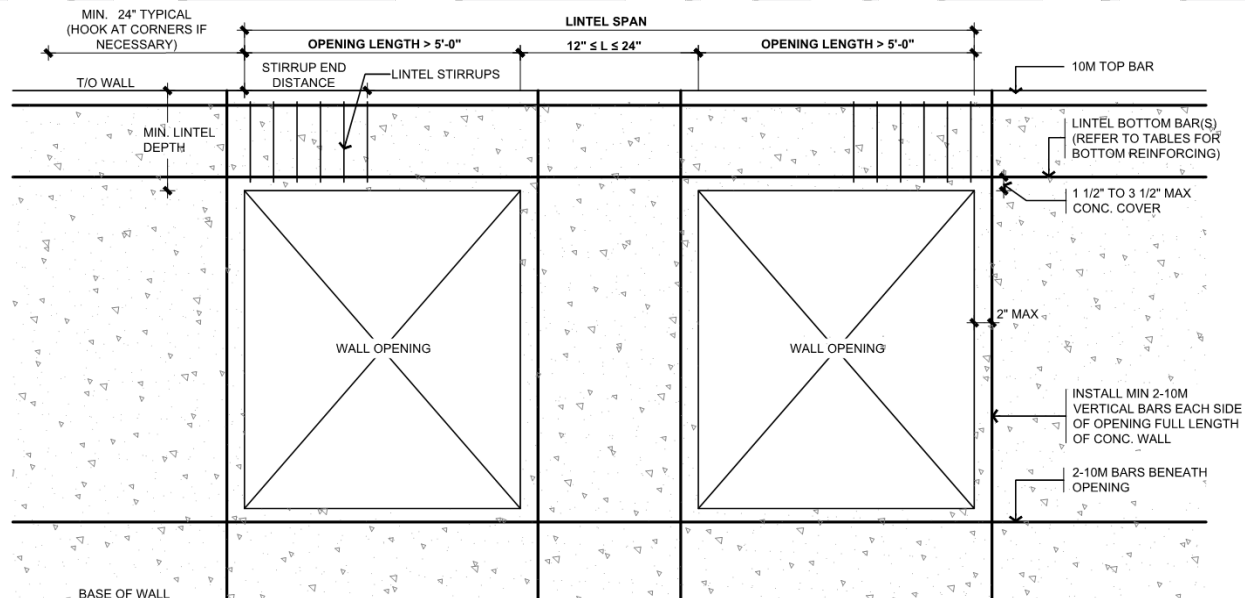

**Detail L. 5. Lintel Span with Less Than 610mm (24") of Wall Between Openings, and Openings Are Greater Than 1.53m (5'-0") in Length.**

**Table L. 1. 6" Lintel Reinforcement with Uniformly Distributed Load**

| Lintel Span, mm (ft) | Lintel - 6" Thick x 8" Deep (150mm Thick x 200mm Deep), s = 3" (75mm) |                   |                     |                   |                     |                   |                     |                   |                     |                   |                     |                   |                     |                   |                     |                   |                     |                   |
|----------------------|---|-------------------|---------------------|-------------------|---------------------|-------------------|---------------------|-------------------|---------------------|-------------------|---------------------|-------------------|---------------------|-------------------|---------------------|-------------------|---------------------|-------------------|
|                      | Uniformly Distributed Load  |                   |                     |                   |                     |                   |                     |                   |                     |                   |                     |                   |                     |                   |                     |                   |                     |                   |
|                      | 7.5 kN/m  |                   | 11 kN/m             |                   | 14.5 kN/m           |                   | 18 kN/m             |                   | 21.5 kN/m           |                   | 25.5 kN/m           |                   | 29 kN/m             |                   | 33 kN/m             |                   | 36.5 kN/m           |                   |
|                      | 500 lb/ft   |                   | 750 lb/ft           |                   | 1000 lb/ft          |                   | 1250 lb/ft          |                   | 1500 lb/ft          |                   | 1750 lb/ft          |                   | 2000 lb/ft          |                   | 2250 lb/ft          |                   | 2500 lb/ft          |                   |
|                      | Bottom Reinf. Steel   | Stirrup End Dist. | Bottom Reinf. Steel | Stirrup End Dist. | Bottom Reinf. Steel | Stirrup End Dist. | Bottom Reinf. Steel | Stirrup End Dist. | Bottom Reinf. Steel | Stirrup End Dist. | Bottom Reinf. Steel | Stirrup End Dist. | Bottom Reinf. Steel | Stirrup End Dist. | Bottom Reinf. Steel | Stirrup End Dist. | Bottom Reinf. Steel | Stirrup End Dist. |
| 900 (3)              | 1-10M   | 0                 | 1-10M               | 0                 | 1-10M               | 0                 | 1-10M               | 0                 | 1-15M               | 150 (6)           | 1-15M               | 150 (6)           | 1-15M               | 225 (9)           | 1-15M               | 225 (9)           | 1-15M               | 300 (12)          |
| 1200 (4)             | 1-10M   | 0                 | 1-15M               | 0                 | 1-15M               | 150 (6)           | 1-15M               | 225 (9)           | 1-20M               | 225 (9)           | 1-20M               | 300 (12)          |                     |                   |                     |                   |                     |                   |
| 1500 (5)             | 1-15M   | 0                 | 1-15M               | 150 (6)           | 1-20M               | 225 (9)           |                     |                   |                     |                   |                     |                   |                     |                   |                     |                   |                     |                   |
| 1800 (6)             | 1-15M   | 0                 | 1-20M               | 225 (9)           |                     |                   |                     |                   |                     |                   |                     |                   |                     |                   |                     |                   |                     |                   |
| 2400 (8)             |   |                   |                     |                   |                     |                   |                     |                   |                     |                   |                     |                   |                     |                   |                     |                   |                     |                   |
| 3000 (10)            |   |                   |                     |                   |                     |                   |                     |                   |                     |                   |                     |                   |                     |                   |                     |                   |                     |                   |
| 3600 (12)            |   |                   |                     |                   |                     |                   |                     |                   |                     |                   |                     |                   |                     |                   |                     |                   |                     |                   |
| 4200 (14)            |   |                   |                     |                   |                     |                   |                     |                   |                     |                   |                     |                   |                     |                   |                     |                   |                     |                   |
| 4800 (16)            |   |                   |                     |                   |                     |                   |                     |                   |                     |                   |                     |                   |                     |                   |                     |                   |                     |                   |
| 5400 (18)            |   |                   |                     |                   |                     |                   |                     |                   |                     |                   |                     |                   |                     |                   |                     |                   |                     |                   |
| 6000 (20)            |   |                   |                     |                   |                     |                   |                     |                   |                     |                   |                     |                   |                     |                   |                     |                   |                     |                   |

**NOTES:**

1. Stirrup spacing (s) and end distance are given in "mm" and "inch"
2. Do not install more than 1-20M bottom bar or equivalent combination of smaller bars.
3. Bottom reinforcement located 89mm (3.5") from bottom of lintel.
4. This table to be used in conjunction with the "Lintel Design Limitations" & "Lintel Drawing".
5. Cells with zero end distance do not require stirrups, except provide a minimum of three stirrups at each end of the lintel where  $S_{a,ICF} > 0.16$ .

| Lintel Span, mm (ft) | Lintel - 6" Thick x 12" Deep (150mm Thick x 300mm Deep), s = 6" (150mm) |                   |                     |                   |                     |                   |                     |                   |                     |                   |                     |                   |                     |                   |                     |                   |                     |                   |
|----------------------|---|-------------------|---------------------|-------------------|---------------------|-------------------|---------------------|-------------------|---------------------|-------------------|---------------------|-------------------|---------------------|-------------------|---------------------|-------------------|---------------------|-------------------|
|                      | Uniformly Distributed Load  |                   |                     |                   |                     |                   |                     |                   |                     |                   |                     |                   |                     |                   |                     |                   |                     |                   |
|                      | 7.5 kN/m  |                   | 11 kN/m             |                   | 14.5 kN/m           |                   | 18 kN/m             |                   | 21.5 kN/m           |                   | 25.5 kN/m           |                   | 29 kN/m             |                   | 33 kN/m             |                   | 36.5 kN/m           |                   |
|                      | 500 lb/ft   |                   | 750 lb/ft           |                   | 1000 lb/ft          |                   | 1250 lb/ft          |                   | 1500 lb/ft          |                   | 1750 lb/ft          |                   | 2000 lb/ft          |                   | 2250 lb/ft          |                   | 2500 lb/ft          |                   |
|                      | Bottom Reinf. Steel   | Stirrup End Dist. | Bottom Reinf. Steel | Stirrup End Dist. | Bottom Reinf. Steel | Stirrup End Dist. | Bottom Reinf. Steel | Stirrup End Dist. | Bottom Reinf. Steel | Stirrup End Dist. | Bottom Reinf. Steel | Stirrup End Dist. | Bottom Reinf. Steel | Stirrup End Dist. | Bottom Reinf. Steel | Stirrup End Dist. | Bottom Reinf. Steel | Stirrup End Dist. |
| 900 (3)              | 1-10M   | 0                 | 1-10M               | 0                 | 1-10M               | 0                 | 1-10M               | 0                 | 1-10M               | 0                 | 1-10M               | 0                 | 1-10M               | 300 (12)          | 1-15M               | 300 (12)          | 1-15M               | 300 (12)          |
| 1200 (4)             | 1-10M   | 0                 | 1-10M               | 0                 | 1-10M               | 0                 | 1-15M               | 0                 | 1-15M               | 300 (12)          | 1-15M               | 300 (12)          | 1-15M               | 300 (12)          | 1-15M               | 300 (12)          | 1-15M               | 450 (18)          |
| 1500 (5)             | 1-10M   | 0                 | 1-15M               | 0                 | 1-15M               | 0                 | 1-15M               | 300 (12)          | 1-15M               | 300 (12)          | 1-15M               | 450 (18)          | 1-20M               | 450 (18)          | 1-20M               | 450 (18)          | 1-20M               | 600 (24)          |
| 1800 (6)             | 1-15M   | 0                 | 1-15M               | 0                 | 1-15M               | 300 (12)          | 1-15M               | 300 (12)          | 1-20M               | 450 (18)          | 1-20M               | 600 (24)          | 2-15M               | 600 (24)          | 2-15M               | 600 (24)          | 1-15M + 1-20M       | 750 (30)          |
| 2400 (8)             | 1-15M   | 0                 | 1-20M               | 300 (12)          | 2-15M               | 600 (24)          | 2-15M               | 600 (24)          | 1-15M + 1-20M       | 750 (30)          |                     |                   |                     |                   |                     |                   |                     |                   |
| 3000 (10)            | 1-20M   | 300 (12)          | 2-15M               | 600 (24)          |                     |                   |                     |                   |                     |                   |                     |                   |                     |                   |                     |                   |                     |                   |
| 3600 (12)            | 1-15M + 1-20M   | 600 (24)          |                     |                   |                     |                   |                     |                   |                     |                   |                     |                   |                     |                   |                     |                   |                     |                   |
| 4200 (14)            |   |                   |                     |                   |                     |                   |                     |                   |                     |                   |                     |                   |                     |                   |                     |                   |                     |                   |
| 4800 (16)            |   |                   |                     |                   |                     |                   |                     |                   |                     |                   |                     |                   |                     |                   |                     |                   |                     |                   |
| 5400 (18)            |   |                   |                     |                   |                     |                   |                     |                   |                     |                   |                     |                   |                     |                   |                     |                   |                     |                   |
| 6000 (20)            |   |                   |                     |                   |                     |                   |                     |                   |                     |                   |                     |                   |                     |                   |                     |                   |                     |                   |

**NOTES:**

1. Stirrup spacing (s) and end distance are given in "mm" and "inch"
2. Do not install more than 1-15M + 1-20M bottom bar or equivalent combination of smaller bars.
3. Bottom reinforcement located 89mm (3.5") from bottom of lintel.
4. This table to be used in conjunction with the "Lintel Design Limitations" & "Lintel Drawing".
5. Cells with zero end distance do not require stirrups, except provide a minimum of three stirrups at each end of the lintel where  $S_{a,ICF} > 0.16$ .



| Lintel Span, mm (ft) | Lintel - 6" Thick x 16" Deep (150mm Thick x 400mm Deep), s = 8" (200mm) |                   |                      |                   |                         |                   |                       |                   |                         |                   |                         |                   |                       |                   |                         |                   |                         |                   |
|----------------------|---|-------------------|----------------------|-------------------|-------------------------|-------------------|-----------------------|-------------------|-------------------------|-------------------|-------------------------|-------------------|-----------------------|-------------------|-------------------------|-------------------|-------------------------|-------------------|
|                      | Uniformly Distributed Load  |                   |                      |                   |                         |                   |                       |                   |                         |                   |                         |                   |                       |                   |                         |                   |                         |                   |
|                      | 7.5 kN/m<br>500 lb/ft   |                   | 11 kN/m<br>750 lb/ft |                   | 14.5 kN/m<br>1000 lb/ft |                   | 18 kN/m<br>1250 lb/ft |                   | 21.5 kN/m<br>1500 lb/ft |                   | 25.5 kN/m<br>1750 lb/ft |                   | 29 kN/m<br>2000 lb/ft |                   | 36.5 kN/m<br>2500 lb/ft |                   | 43.5 kN/m<br>3000 lb/ft |                   |
|                      | Bottom Reinf. Steel   | Stirrup End Dist. | Bottom Reinf. Steel  | Stirrup End Dist. | Bottom Reinf. Steel     | Stirrup End Dist. | Bottom Reinf. Steel   | Stirrup End Dist. | Bottom Reinf. Steel     | Stirrup End Dist. | Bottom Reinf. Steel     | Stirrup End Dist. | Bottom Reinf. Steel   | Stirrup End Dist. | Bottom Reinf. Steel     | Stirrup End Dist. | Bottom Reinf. Steel     | Stirrup End Dist. |
| 900 (3)              | 1-10M   | 0                 | 1-10M                | 0                 | 1-10M                   | 0                 | 1-10M                 | 0                 | 1-10M                   | 0                 | 1-10M                   | 0                 | 1-10M                 | 0                 | 1-10M                   | 0                 | 1-10M                   | 400 (16)          |
| 1200 (4)             | 1-10M   | 0                 | 1-10M                | 0                 | 1-10M                   | 0                 | 1-10M                 | 0                 | 1-10M                   | 0                 | 1-10M                   | 0                 | 1-15M                 | 400 (16)          | 1-15M                   | 400 (16)          | 1-15M                   | 400 (16)          |
| 1500 (5)             | 1-10M   | 0                 | 1-10M                | 0                 | 1-10M                   | 0                 | 1-15M                 | 0                 | 1-15M                   | 400 (16)          | 1-15M                   | 400 (16)          | 1-15M                 | 400 (16)          | 1-15M                   | 600 (24)          | 1-15M                   | 600 (24)          |
| 1800 (6)             | 1-10M   | 0                 | 1-15M                | 0                 | 1-15M                   | 0                 | 1-15M                 | 400 (16)          | 1-15M                   | 400 (16)          | 1-15M                   | 400 (16)          | 1-15M                 | 600 (24)          | 1-20M                   | 600 (24)          | 2-20M                   | 800 (32)          |
| 2400 (8)             | 1-15M   | 0                 | 1-15M                | 0                 | 1-15M                   | 400 (16)          | 1-20M                 | 600 (24)          | 1-20M                   | 600 (24)          | 2-15M                   | 800 (32)          | 2-15M                 | 800 (32)          | 1-15M + 1-20M           | 1000 (40)         |                         |                   |
| 3000 (10)            | 1-15M   | 0                 | 1-20M                | 400 (16)          | 2-15M                   | 600 (24)          | 2-15M                 | 800 (32)          | 1-15M + 1-20M           | 1000 (40)         | 2-20M                   | 1000 (40)         | 1-10M + 2-20M         | 1200 (48)         |                         |                   |                         |                   |
| 3600 (12)            | 1-20M   | 400 (16)          | 2-15M                | 800 (32)          | 1-15M + 1-20M           | 1000 (40)         | 1-10M + 2-20M         | 1200 (48)         | 1-15M + 2-20M           | 1200 (48)         |                         |                   |                       |                   |                         |                   |                         |                   |
| 4200 (14)            | 2-15M   | 600 (24)          | 2-20M                | 1000 (40)         | 1-15M + 2-20M           | 1200 (48)         |                       |                   |                         |                   |                         |                   |                       |                   |                         |                   |                         |                   |
| 4800 (16)            | 2-20M   | 800 (32)          | 1-15M + 2-20M        | 1400 (56)         |                         |                   |                       |                   |                         |                   |                         |                   |                       |                   |                         |                   |                         |                   |
| 5400 (18)            | 1-15M + 2-20M   | 1200 (48)         |                      |                   |                         |                   |                       |                   |                         |                   |                         |                   |                       |                   |                         |                   |                         |                   |
| 6000 (20)            |   |                   |                      |                   |                         |                   |                       |                   |                         |                   |                         |                   |                       |                   |                         |                   |                         |                   |

NOTES:

1. Stirrup spacing (s) and end distance are given in "mm" and "inch"
2. Do not install more than 1-15M + 2-20M bottom bar or equivalent combination of smaller bars.
3. Bottom reinforcement located 89mm (3.5") from bottom of lintel.
4. This table to be used in conjunction with the "Lintel Design Limitations" & "Lintel Drawing".
5. Cells with zero end distance do not require stirrups, except provide a minimum of three stirrups at each end of the lintel where  $S_a(0.2) > 0.16$ .

| Lintel Span, mm (ft) | Lintel - 6" Thick x 24" Deep (150mm Thick x 600mm Deep), s = 12" (300mm) |                   |                      |                   |                         |                   |                       |                   |                         |                   |                       |                   |                         |                   |                         |                   |                       |                   |
|----------------------|--|-------------------|----------------------|-------------------|-------------------------|-------------------|-----------------------|-------------------|-------------------------|-------------------|-----------------------|-------------------|-------------------------|-------------------|-------------------------|-------------------|-----------------------|-------------------|
|                      | Uniformly Distributed Load   |                   |                      |                   |                         |                   |                       |                   |                         |                   |                       |                   |                         |                   |                         |                   |                       |                   |
|                      | 7.5 kN/m<br>500 lb/ft  |                   | 11 kN/m<br>750 lb/ft |                   | 14.5 kN/m<br>1000 lb/ft |                   | 18 kN/m<br>1250 lb/ft |                   | 21.5 kN/m<br>1500 lb/ft |                   | 29 kN/m<br>2000 lb/ft |                   | 36.5 kN/m<br>2500 lb/ft |                   | 43.5 kN/m<br>3000 lb/ft |                   | 51 kN/m<br>3500 lb/ft |                   |
|                      | Bottom Reinf. Steel  | Stirrup End Dist. | Bottom Reinf. Steel  | Stirrup End Dist. | Bottom Reinf. Steel     | Stirrup End Dist. | Bottom Reinf. Steel   | Stirrup End Dist. | Bottom Reinf. Steel     | Stirrup End Dist. | Bottom Reinf. Steel   | Stirrup End Dist. | Bottom Reinf. Steel     | Stirrup End Dist. | Bottom Reinf. Steel     | Stirrup End Dist. | Bottom Reinf. Steel   | Stirrup End Dist. |
| 900 (3)              | 1-10M  | 0                 | 1-10M                | 0                 | 1-10M                   | 0                 | 1-10M                 | 0                 | 1-10M                   | 0                 | 1-10M                 | 0                 | 1-10M                   | 0                 | 1-10M                   | 0                 | 1-10M                 | 0                 |
| 1200 (4)             | 1-10M  | 0                 | 1-10M                | 0                 | 1-10M                   | 0                 | 1-10M                 | 0                 | 1-10M                   | 0                 | 1-10M                 | 0                 | 1-10M                   | 0                 | 1-10M                   | 600 (24)          | 1-15M                 | 600 (24)          |
| 1500 (5)             | 1-10M  | 0                 | 1-10M                | 0                 | 1-10M                   | 0                 | 1-10M                 | 0                 | 1-10M                   | 0                 | 1-15M                 | 0                 | 1-15M                   | 600 (24)          | 1-15M                   | 600 (24)          | 1-15M                 | 600 (24)          |
| 1800 (6)             | 1-10M  | 0                 | 1-10M                | 0                 | 1-10M                   | 0                 | 1-15M                 | 0                 | 1-15M                   | 0                 | 1-15M                 | 600 (24)          | 1-15M                   | 600 (24)          | 1-15M                   | 600 (24)          | 1-15M                 | 600 (24)          |
| 2400 (8)             | 1-10M  | 0                 | 1-15M                | 0                 | 1-15M                   | 0                 | 1-15M                 | 600 (24)          | 1-15M                   | 600 (24)          | 1-20M                 | 600 (24)          | 1-20M                   | 900 (36)          | 2-15M                   | 900 (36)          | 2-15M                 | 900 (36)          |
| 3000 (10)            | 1-15M  | 0                 | 1-15M                | 0                 | 1-15M                   | 600 (24)          | 1-20M                 | 600 (24)          | 1-20M                   | 900 (36)          | 2-15M                 | 900 (36)          | 1-15M + 1-20M           | 1200 (48)         | 2-20M                   | 1200 (48)         |                       |                   |
| 3600 (12)            | 1-15M  | 0                 | 1-20M                | 600 (24)          | 1-20M                   | 600 (24)          | 2-15M                 | 900 (36)          | 2-15M                   | 1200 (48)         | 2-20M                 | 1200 (48)         | 1-10M + 2-20M           | 1500 (60)         |                         |                   |                       |                   |
| 4200 (14)            | 1-20M  | 0                 | 1-20M                | 600 (24)          | 2-15M                   | 900 (36)          | 1-15M + 1-20M         | 1200 (48)         | 2-20M                   | 1500 (60)         | 1-15M + 2-20M         | 1500 (60)         |                         |                   |                         |                   |                       |                   |
| 4800 (16)            | 1-20M  | 600 (24)          | 2-15M                | 900 (36)          | 1-15M + 1-20M           | 1200 (48)         | 1-10M + 2-20M         | 1500 (60)         | 1-15M + 2-20M           | 1800 (72)         | 1-15M + 3-20M         | 1800 (72)         |                         |                   |                         |                   |                       |                   |
| 5400 (18)            | 2-15M  | 600 (24)          | 2-20M                | 1200 (48)         | 1-10M + 2-20M           | 1500 (60)         | 3-20M                 | 1800 (72)         | 1-15M + 3-20M           | 2100 (84)         |                       |                   |                         |                   |                         |                   |                       |                   |
| 6000 (20)            | 1-15M + 1-20M  | 900 (36)          | 1-10M + 2-20M        | 1500 (60)         | 3-20M                   | 1800 (72)         | 1-15M + 3-20M         | 2100 (84)         |                         |                   |                       |                   |                         |                   |                         |                   |                       |                   |

NOTES:

1. Stirrup spacing (s) and end distance are given in "mm" and "inch"
2. Do not install more than 4-20M bottom bar or equivalent combination of smaller bars.
3. Bottom reinforcement located 89mm (3.5") from bottom of lintel.
4. This table to be used in conjunction with the "Lintel Design Limitations" & "Lintel Drawing".
5. Cells with zero end distance do not require stirrups, except provide a minimum of three stirrups at each end of the lintel where  $S_{a,ICF} > 0.16$ .



| Lintel Span, mm (ft) | Lintel - 6" Thick x 32" Deep (150mm Thick x 800mm Deep), s = 16" (400mm) |                   |                      |                   |                         |                   |                       |                   |                         |                   |                       |                   |                         |                   |                         |                   |                       |                   |
|----------------------|--|-------------------|----------------------|-------------------|-------------------------|-------------------|-----------------------|-------------------|-------------------------|-------------------|-----------------------|-------------------|-------------------------|-------------------|-------------------------|-------------------|-----------------------|-------------------|
|                      | Uniformly Distributed Load   |                   |                      |                   |                         |                   |                       |                   |                         |                   |                       |                   |                         |                   |                         |                   |                       |                   |
|                      | 7.5 kN/m<br>500 lb/ft  |                   | 11 kN/m<br>750 lb/ft |                   | 14.5 kN/m<br>1000 lb/ft |                   | 18 kN/m<br>1250 lb/ft |                   | 21.5 kN/m<br>1500 lb/ft |                   | 29 kN/m<br>2000 lb/ft |                   | 36.5 kN/m<br>2500 lb/ft |                   | 43.5 kN/m<br>3000 lb/ft |                   | 51 kN/m<br>3500 lb/ft |                   |
|                      | Bottom Reinf. Steel  | Stirrup End Dist. | Bottom Reinf. Steel  | Stirrup End Dist. | Bottom Reinf. Steel     | Stirrup End Dist. | Bottom Reinf. Steel   | Stirrup End Dist. | Bottom Reinf. Steel     | Stirrup End Dist. | Bottom Reinf. Steel   | Stirrup End Dist. | Bottom Reinf. Steel     | Stirrup End Dist. | Bottom Reinf. Steel     | Stirrup End Dist. | Bottom Reinf. Steel   | Stirrup End Dist. |
| 900 (3)              | 1-10M  | 0                 | 1-10M                | 0                 | 1-10M                   | 0                 | 1-10M                 | 0                 | 1-10M                   | 0                 | 1-10M                 | 0                 | 1-10M                   | 0                 | 1-10M                   | 0                 | 1-10M                 | 0                 |
| 1200 (4)             | 1-10M  | 0                 | 1-10M                | 0                 | 1-10M                   | 0                 | 1-10M                 | 0                 | 1-10M                   | 0                 | 1-10M                 | 0                 | 1-10M                   | 0                 | 1-10M                   | 0                 | 1-10M                 | 400 (16)          |
| 1500 (5)             | 1-10M  | 0                 | 1-10M                | 0                 | 1-10M                   | 0                 | 1-10M                 | 0                 | 1-10M                   | 0                 | 1-10M                 | 0                 | 1-10M                   | 0                 | 1-15M                   | 400 (16)          | 1-15M                 | 400 (16)          |
| 1800 (6)             | 1-10M  | 0                 | 1-10M                | 0                 | 1-10M                   | 0                 | 1-10M                 | 0                 | 1-10M                   | 0                 | 1-15M                 | 0                 | 1-15M                   | 800 (32)          | 1-15M                   | 800 (32)          | 1-15M                 | 800 (32)          |
| 2400 (8)             | 1-10M  | 0                 | 1-10M                | 0                 | 1-15M                   | 0                 | 1-15M                 | 0                 | 1-15M                   | 0                 | 1-20M                 | 800 (32)          | 1-20M                   | 800 (32)          | 1-20M                   | 800 (32)          | 1-20M                 | 1200 (48)         |
| 3000 (10)            | 1-15M  | 0                 | 1-15M                | 0                 | 1-15M                   | 0                 | 1-20M                 | 800 (32)          | 1-20M                   | 800 (32)          | 1-20M                 | 800 (32)          | 2-15M                   | 1200 (48)         | 2-15M                   | 1200 (48)         | 1-15M+                | 1200 (48)         |
| 3600 (12)            | 1-15M  | 0                 | 1-20M                | 0                 | 1-20M                   | 800 (32)          | 1-20M                 | 800 (32)          | 1-20M                   | 800 (32)          | 2-15M                 | 1200 (48)         | 1-15M+                  | 1600 (64)         |                         |                   |                       |                   |
| 4200 (14)            | 1-20M  | 0                 | 1-20M                | 0                 | 1-20M                   | 800 (32)          | 2-15M                 | 1200 (48)         | 2-15M                   | 1200 (48)         | 1-15M+                | 1600 (64)         | 1-20M+                  | 2000 (80)         |                         |                   |                       |                   |
| 4800 (16)            | 1-20M  | 0                 | 1-20M                | 800 (32)          | 2-15M                   | 1200 (48)         | 1-15M+                | 1200 (48)         | 1-15M+                  | 1600 (64)         | 1-10M+                | 2000 (80)         | 2-20M                   | 800 (32)          |                         |                   |                       |                   |
| 5400 (18)            | 1-20M  | 0                 | 2-15M                | 800 (32)          | 1-15M+                  | 1200 (48)         | 2-20M                 | 1600 (64)         | 1-10M+                  | 2000 (80)         |                       |                   |                         |                   |                         |                   |                       |                   |
| 6000 (20)            | 2-15M  | 800 (32)          | 1-15M+               | 1200 (48)         | 2-20M                   | 1600 (64)         | 1-10M+                | 2000 (80)         | 3-20M                   | 2000 (80)         |                       |                   |                         |                   |                         |                   |                       |                   |

NOTES:

1. Stirrup spacing (s) and end distance are given in "mm" and "inch"
2. Do not install more than 4-20M bottom bar or equivalent combination of smaller bars.
3. Bottom reinforcement located 89mm (3.5") from bottom of lintel.
4. This table to be used in conjunction with the "Lintel Design Limitations" & "Lintel Drawing".
5. Cells with zero end distance do not require stirrups, except provide a minimum of three stirrups at each end of the lintel where  $S_{a,ICF} > 0.16$ .



# INSULATING CONCRETE FORMS MANUFACTURERS ASSOCIATION



**Table L. 2. 8" Lintel Reinforcement with Uniformly Distributed Load**

| Lintel Span, mm (ft) | Lintel - 8" Thick x 8" Deep (200mm Thick x 200mm Deep), s = 3" (75mm) |                   |                     |                   |                     |                   |                     |                   |                     |                   |                     |                   |                     |                   |                     |                   |                     |                   |
|----------------------|---|-------------------|---------------------|-------------------|---------------------|-------------------|---------------------|-------------------|---------------------|-------------------|---------------------|-------------------|---------------------|-------------------|---------------------|-------------------|---------------------|-------------------|
|                      | Uniformly Distributed Load  |                   |                     |                   |                     |                   |                     |                   |                     |                   |                     |                   |                     |                   |                     |                   |                     |                   |
|                      | 7.5 kN/m  |                   | 11 kN/m             |                   | 14.5 kN/m           |                   | 18 kN/m             |                   | 21.5 kN/m           |                   | 25.5 kN/m           |                   | 29 kN/m             |                   | 33 kN/m             |                   | 36.5 kN/m           |                   |
|                      | 500 lb/ft   |                   | 750 lb/ft           |                   | 1000 lb/ft          |                   | 1250 lb/ft          |                   | 1500 lb/ft          |                   | 1750 lb/ft          |                   | 2000 lb/ft          |                   | 2250 lb/ft          |                   | 2500 lb/ft          |                   |
|                      | Bottom Reinf. Steel   | Stirrup End Dist. | Bottom Reinf. Steel | Stirrup End Dist. | Bottom Reinf. Steel | Stirrup End Dist. | Bottom Reinf. Steel | Stirrup End Dist. | Bottom Reinf. Steel | Stirrup End Dist. | Bottom Reinf. Steel | Stirrup End Dist. | Bottom Reinf. Steel | Stirrup End Dist. | Bottom Reinf. Steel | Stirrup End Dist. | Bottom Reinf. Steel | Stirrup End Dist. |
| 900 (3)              | 1-10M   | 0                 | 1-10M               | 0                 | 1-10M               | 0                 | 1-15M               | 0                 | 1-15M               | 0                 | 1-15M               | 150 (6)           | 1-15M               | 150 (6)           | 1-15M               | 225 (9)           | 1-15M               | 225 (9)           |
| 1200 (4)             | 1-15M   | 0                 | 1-15M               | 0                 | 1-15M               | 0                 | 1-15M               | 150 (6)           | 1-15M               | 150 (6)           | 1-20M               | 225 (9)           | 1-20M               | 300 (12)          |                     |                   |                     |                   |
| 1500 (5)             | 1-15M   | 0                 | 1-15M               | 0                 | 1-20M               | 150 (6)           | 1-20M               | 225 (9)           |                     |                   |                     |                   |                     |                   |                     |                   |                     |                   |
| 1800 (6)             | 1-15M   | 0                 | 1-20M               | 150 (6)           |                     |                   |                     |                   |                     |                   |                     |                   |                     |                   |                     |                   |                     |                   |
| 2400 (8)             |   |                   |                     |                   |                     |                   |                     |                   |                     |                   |                     |                   |                     |                   |                     |                   |                     |                   |
| 3000 (10)            |   |                   |                     |                   |                     |                   |                     |                   |                     |                   |                     |                   |                     |                   |                     |                   |                     |                   |
| 3600 (12)            |   |                   |                     |                   |                     |                   |                     |                   |                     |                   |                     |                   |                     |                   |                     |                   |                     |                   |
| 4200 (14)            |   |                   |                     |                   |                     |                   |                     |                   |                     |                   |                     |                   |                     |                   |                     |                   |                     |                   |
| 4800 (16)            |   |                   |                     |                   |                     |                   |                     |                   |                     |                   |                     |                   |                     |                   |                     |                   |                     |                   |
| 5400 (18)            |   |                   |                     |                   |                     |                   |                     |                   |                     |                   |                     |                   |                     |                   |                     |                   |                     |                   |
| 6000 (20)            |   |                   |                     |                   |                     |                   |                     |                   |                     |                   |                     |                   |                     |                   |                     |                   |                     |                   |

NOTES:

1. Stirrup spacing (s) and end distance are given in "mm" and "inch"
2. Do not install more than 1-20M bottom bar or equivalent combination of smaller bars.
3. Bottom reinforcement located 89mm (3.5") from bottom of lintel.
4. This table to be used in conjunction with the "Lintel Design Limitations" & "Lintel Drawing".
5. Cells with zero end distance do not require stirrups, except provide a minimum of three stirrups at each end of the lintel where  $S_{a,ICF} > 0.16$ .

| Lintel Span, mm (ft) | Lintel - 8" Thick x 12" Deep (200mm Thick x 300mm Deep), s = 6" (150mm) |                   |                     |                   |                     |                   |                     |                   |                     |                   |                     |                   |                     |                   |                     |                   |                     |                   |
|----------------------|---|-------------------|---------------------|-------------------|---------------------|-------------------|---------------------|-------------------|---------------------|-------------------|---------------------|-------------------|---------------------|-------------------|---------------------|-------------------|---------------------|-------------------|
|                      | Uniformly Distributed Load  |                   |                     |                   |                     |                   |                     |                   |                     |                   |                     |                   |                     |                   |                     |                   |                     |                   |
|                      | 7.5 kN/m  |                   | 11 kN/m             |                   | 14.5 kN/m           |                   | 18 kN/m             |                   | 21.5 kN/m           |                   | 25.5 kN/m           |                   | 29 kN/m             |                   | 33 kN/m             |                   | 36.5 kN/m           |                   |
|                      | 500 lb/ft   |                   | 750 lb/ft           |                   | 1000 lb/ft          |                   | 1250 lb/ft          |                   | 1500 lb/ft          |                   | 1750 lb/ft          |                   | 2000 lb/ft          |                   | 2250 lb/ft          |                   | 2500 lb/ft          |                   |
|                      | Bottom Reinf. Steel   | Stirrup End Dist. | Bottom Reinf. Steel | Stirrup End Dist. | Bottom Reinf. Steel | Stirrup End Dist. | Bottom Reinf. Steel | Stirrup End Dist. | Bottom Reinf. Steel | Stirrup End Dist. | Bottom Reinf. Steel | Stirrup End Dist. | Bottom Reinf. Steel | Stirrup End Dist. | Bottom Reinf. Steel | Stirrup End Dist. | Bottom Reinf. Steel | Stirrup End Dist. |
| 900 (3)              | 1-10M   | 0                 | 1-10M               | 0                 | 1-10M               | 0                 | 1-10M               | 0                 | 1-10M               | 0                 | 1-10M               | 0                 | 1-10M               | 0                 | 1-15M               | 0                 | 1-15M               | 300 (12)          |
| 1200 (4)             | 1-10M   | 0                 | 1-10M               | 0                 | 1-10M               | 0                 | 1-15M               | 0                 | 1-15M               | 0                 | 1-15M               | 300 (12)          | 1-15M               | 300 (12)          | 1-15M               | 300 (12)          | 1-15M               | 300 (12)          |
| 1500 (5)             | 1-10M   | 0                 | 1-15M               | 0                 | 1-15M               | 0                 | 1-15M               | 0                 | 1-15M               | 300 (12)          | 1-15M               | 300 (12)          | 1-15M               | 300 (12)          | 1-20M               | 450 (18)          | 1-20M               | 450 (18)          |
| 1800 (6)             | 1-15M   | 0                 | 1-15M               | 0                 | 1-15M               | 0                 | 1-15M               | 300 (12)          | 1-20M               | 300 (12)          | 1-20M               | 450 (18)          | 2-15M               | 600 (24)          | 2-15M               | 600 (24)          | 2-15M               | 600 (24)          |
| 2400 (8)             | 1-15M   | 0                 | 1-20M               | 0                 | 1-20M               | 450 (18)          | 2-15M               | 600 (24)          | 1-15M+1-20M         | 600 (24)          | 2-20M               | 750 (30)          |                     |                   |                     |                   |                     |                   |
| 3000 (10)            | 1-20M   | 0                 | 2-15M               | 450 (18)          | 2-20M               | 750 (30)          |                     |                   |                     |                   |                     |                   |                     |                   |                     |                   |                     |                   |
| 3600 (12)            | 1-15M+1-20M   | 300 (12)          |                     |                   |                     |                   |                     |                   |                     |                   |                     |                   |                     |                   |                     |                   |                     |                   |
| 4200 (14)            |   |                   |                     |                   |                     |                   |                     |                   |                     |                   |                     |                   |                     |                   |                     |                   |                     |                   |
| 4800 (16)            |   |                   |                     |                   |                     |                   |                     |                   |                     |                   |                     |                   |                     |                   |                     |                   |                     |                   |
| 5400 (18)            |   |                   |                     |                   |                     |                   |                     |                   |                     |                   |                     |                   |                     |                   |                     |                   |                     |                   |
| 6000 (20)            |   |                   |                     |                   |                     |                   |                     |                   |                     |                   |                     |                   |                     |                   |                     |                   |                     |                   |

NOTES:

1. Stirrup spacing (s) and end distance are given in "mm" and "inch"
2. Do not install more than 2-20M bottom bar or equivalent combination of smaller bars.
3. Bottom reinforcement located 89mm (3.5") from bottom of lintel.
4. This table to be used in conjunction with the "Lintel Design Limitations" & "Lintel Drawing".
5. Cells with zero end distance do not require stirrups, except provide a minimum of three stirrups at each end of the lintel where  $S_{a,ICF} > 0.16$ .



| Lintel Span, mm (ft) | Lintel - 8" Thick x 16" Deep (200mm Thick x 400mm Deep), s = 8" (200mm) |                   |                     |                   |                     |                   |                     |                   |                     |                   |                     |                   |                     |                   |                     |                   |                     |                   |
|----------------------|---|-------------------|---------------------|-------------------|---------------------|-------------------|---------------------|-------------------|---------------------|-------------------|---------------------|-------------------|---------------------|-------------------|---------------------|-------------------|---------------------|-------------------|
|                      | Uniformly Distributed Load  |                   |                     |                   |                     |                   |                     |                   |                     |                   |                     |                   |                     |                   |                     |                   |                     |                   |
|                      | 7.5 kN/m  |                   | 11 kN/m             |                   | 14.5 kN/m           |                   | 18 kN/m             |                   | 21.5 kN/m           |                   | 25.5 kN/m           |                   | 29 kN/m             |                   | 36.5 kN/m           |                   | 43.5 kN/m           |                   |
|                      | 500 lb/ft   |                   | 750 lb/ft           |                   | 1000 lb/ft          |                   | 1250 lb/ft          |                   | 1500 lb/ft          |                   | 1750 lb/ft          |                   | 2000 lb/ft          |                   | 2500 lb/ft          |                   | 3000 lb/ft          |                   |
|                      | Bottom Reinf. Steel   | Stirrup End Dist. | Bottom Reinf. Steel | Stirrup End Dist. | Bottom Reinf. Steel | Stirrup End Dist. | Bottom Reinf. Steel | Stirrup End Dist. | Bottom Reinf. Steel | Stirrup End Dist. | Bottom Reinf. Steel | Stirrup End Dist. | Bottom Reinf. Steel | Stirrup End Dist. | Bottom Reinf. Steel | Stirrup End Dist. | Bottom Reinf. Steel | Stirrup End Dist. |
| 900 (3)              | 1-10M   | 0                 | 1-10M               | 0                 | 1-10M               | 0                 | 1-10M               | 0                 | 1-10M               | 0                 | 1-10M               | 0                 | 1-10M               | 0                 | 1-10M               | 0                 | 1-10M               | 0                 |
| 1200 (4)             | 1-10M   | 0                 | 1-10M               | 0                 | 1-10M               | 0                 | 1-10M               | 0                 | 1-10M               | 0                 | 1-10M               | 0                 | 1-15M               | 0                 | 1-15M               | 400 (16)          | 1-15M               | 400 (16)          |
| 1500 (5)             | 1-10M   | 0                 | 1-10M               | 0                 | 1-10M               | 0                 | 1-15M               | 0                 | 1-15M               | 0                 | 1-15M               | 400 (16)          | 1-15M               | 400 (16)          | 1-15M               | 400 (16)          | 1-15M               | 400 (16)          |
| 1800 (6)             | 1-10M   | 0                 | 1-15M               | 0                 | 1-15M               | 0                 | 1-15M               | 0                 | 1-15M               | 400 (16)          | 1-15M               | 400 (16)          | 1-15M               | 400 (16)          | 1-20M               | 600 (24)          | 1-20M               | 600 (24)          |
| 2400 (8)             | 1-15M   | 0                 | 1-15M               | 0                 | 1-15M               | 0                 | 1-20M               | 400 (16)          | 1-20M               | 600 (24)          | 2-15M               | 600 (24)          | 2-15M               | 800 (32)          | 1-15M + 1-20M       | 800 (32)          | 2-20M               | 1000 (40)         |
| 3000 (10)            | 1-15M   | 0                 | 1-20M               | 0                 | 2-15M               | 400 (16)          | 2-15M               | 800 (32)          | 1-15M + 1-20M       | 800 (32)          | 2-20M               | 1000 (40)         | 1-10M + 2-20M       | 1000 (40)         |                     |                   |                     |                   |
| 3600 (12)            | 1-20M   | 0                 | 2-15M               | 600 (24)          | 1-15M + 1-20M       | 800 (32)          | 2-20M               | 1000 (40)         | 1-10M + 2-20M       | 1200 (48)         | 3-20M               | 1200 (48)         |                     |                   |                     |                   |                     |                   |
| 4200 (14)            | 2-15M   | 400 (16)          | 2-20M               | 800 (32)          | 1-10M + 2-20M       | 1200 (48)         | 3-20M               | 1400 (56)         |                     |                   |                     |                   |                     |                   |                     |                   |                     |                   |
| 4800 (16)            | 2-20M   | 600 (24)          | 1-15M + 2-20M       | 1200 (48)         |                     |                   |                     |                   |                     |                   |                     |                   |                     |                   |                     |                   |                     |                   |
| 5400 (18)            | 1-10M + 2-20M   | 1000 (40)         |                     |                   |                     |                   |                     |                   |                     |                   |                     |                   |                     |                   |                     |                   |                     |                   |
| 6000 (20)            | 3-20M   | 1200 (48)         |                     |                   |                     |                   |                     |                   |                     |                   |                     |                   |                     |                   |                     |                   |                     |                   |

NOTES:

1. Stirrup spacing (s) and end distance are given in "mm" and "inch"
2. Do not install more than 3-20M bottom bar or equivalent combination of smaller bars.
3. Bottom reinforcement located 89mm (3.5") from bottom of lintel.
4. This table to be used in conjunction with the "Lintel Design Limitations" & "Lintel Drawing".
5. Cells with zero end distance do not require stirrups, except provide a minimum of three stirrups at each end of the lintel where  $S_{a,ICF} > 0.16$ .

| Lintel Span, mm (ft) | Lintel - 8" Thick x 24" Deep (200mm Thick x 600mm Deep), s = 12" (300mm) |                   |                     |                   |                     |                   |                     |                   |                     |                   |                     |                   |                     |                   |                     |                   |                     |                   |
|----------------------|--|-------------------|---------------------|-------------------|---------------------|-------------------|---------------------|-------------------|---------------------|-------------------|---------------------|-------------------|---------------------|-------------------|---------------------|-------------------|---------------------|-------------------|
|                      | Uniformly Distributed Load   |                   |                     |                   |                     |                   |                     |                   |                     |                   |                     |                   |                     |                   |                     |                   |                     |                   |
|                      | 7.5 kN/m   |                   | 11 kN/m             |                   | 14.5 kN/m           |                   | 18 kN/m             |                   | 21.5 kN/m           |                   | 29 kN/m             |                   | 36.5 kN/m           |                   | 43.5 kN/m           |                   | 51 kN/m             |                   |
|                      | 500 lb/ft  |                   | 750 lb/ft           |                   | 1000 lb/ft          |                   | 1250 lb/ft          |                   | 1500 lb/ft          |                   | 2000 lb/ft          |                   | 2500 lb/ft          |                   | 3000 lb/ft          |                   | 3500 lb/ft          |                   |
|                      | Bottom Reinf. Steel  | Stirrup End Dist. | Bottom Reinf. Steel | Stirrup End Dist. | Bottom Reinf. Steel | Stirrup End Dist. | Bottom Reinf. Steel | Stirrup End Dist. | Bottom Reinf. Steel | Stirrup End Dist. | Bottom Reinf. Steel | Stirrup End Dist. | Bottom Reinf. Steel | Stirrup End Dist. | Bottom Reinf. Steel | Stirrup End Dist. | Bottom Reinf. Steel | Stirrup End Dist. |
| 900 (3)              | 1-10M  | 0                 | 1-10M               | 0                 | 1-10M               | 0                 | 1-10M               | 0                 | 1-10M               | 0                 | 1-10M               | 0                 | 1-10M               | 0                 | 1-10M               | 0                 | 1-10M               | 0                 |
| 1200 (4)             | 1-10M  | 0                 | 1-10M               | 0                 | 1-10M               | 0                 | 1-10M               | 0                 | 1-10M               | 0                 | 1-10M               | 0                 | 1-10M               | 0                 | 1-10M               | 0                 | 1-15M               | 600 (24)          |
| 1500 (5)             | 1-10M  | 0                 | 1-10M               | 0                 | 1-10M               | 0                 | 1-10M               | 0                 | 1-10M               | 0                 | 1-15M               | 0                 | 1-15M               | 0                 | 1-15M               | 600 (24)          | 1-15M               | 600 (24)          |
| 1800 (6)             | 1-10M  | 0                 | 1-10M               | 0                 | 1-10M               | 0                 | 1-15M               | 0                 | 1-15M               | 0                 | 1-15M               | 0                 | 1-15M               | 600 (24)          | 1-20M               | 600 (24)          | 1-20M               | 600 (24)          |
| 2400 (8)             | 1-10M  | 0                 | 1-15M               | 0                 | 1-15M               | 0                 | 1-15M               | 0                 | 1-20M               | 600 (24)          | 1-20M               | 600 (24)          | 1-20M               | 900 (36)          | 2-15M               | 900 (36)          | 2-15M               | 900 (36)          |
| 3000 (10)            | 1-15M  | 0                 | 1-20M               | 0                 | 1-20M               | 0                 | 1-20M               | 600 (24)          | 1-20M               | 600 (24)          | 2-15M               | 900 (36)          | 1-15M + 1-20M       | 1200 (48)         | 1-15M + 1-20M       | 1200 (48)         | 2-20M               | 1200 (48)         |
| 3600 (12)            | 1-20M  | 0                 | 1-20M               | 0                 | 1-20M               | 600 (24)          | 2-15M               | 600 (24)          | 2-15M               | 900 (36)          | 1-15M + 1-20M       | 1200 (48)         | 1-10M + 2-20M       | 1500 (60)         |                     |                   |                     |                   |
| 4200 (14)            | 1-20M  | 0                 | 2-15M               | 600 (24)          | 2-15M               | 900 (36)          | 1-15M + 1-20M       | 900 (36)          | 2-20M               | 1200 (48)         | 1-15M + 2-20M       | 1500 (60)         | 1-10M + 3-20M       | 1800 (72)         |                     |                   |                     |                   |
| 4800 (16)            | 2-15M  | 0                 | 2-15M               | 600 (24)          | 2-20M               | 1200 (48)         | 1-10M + 2-20M       | 1200 (48)         | 1-15M + 2-20M       | 1500 (60)         | 1-10M + 3-20M       | 1800 (72)         |                     |                   |                     |                   |                     |                   |
| 5400 (18)            | 2-15M  | 600 (24)          | 2-20M               | 900 (36)          | 1-10M + 2-20M       | 1500 (60)         | 1-15M + 2-20M       | 1500 (60)         | 1-10M + 3-20M       | 1800 (72)         |                     |                   |                     |                   |                     |                   |                     |                   |
| 6000 (20)            | 1-15M + 1-20M  | 600 (24)          | 1-10M + 2-20M       | 1200 (48)         | 3-20M               | 1800 (72)         | 3-20M               | 1800 (72)         |                     |                   |                     |                   |                     |                   |                     |                   |                     |                   |

NOTES:

1. Stirrup spacing (s) and end distance are given in "mm" and "inch"
2. Do not install more than 4-20M bottom bar or equivalent combination of smaller bars.
3. Bottom reinforcement located 89mm (3.5") from bottom of lintel.
4. This table to be used in conjunction with the "Lintel Design Limitations" & "Lintel Drawing".
5. Cells with zero end distance do not require stirrups, except provide a minimum of three stirrups at each end of the lintel where  $S_{a,ICF} > 0.16$ .



| Lintel Span, mm (ft) | Lintel - 8" Thick x 32" Deep (200mm Thick x 800mm Deep), s = 16" (400mm) |                   |                      |                   |                         |                   |                       |                   |                         |                   |                       |                   |                         |                   |                         |                   |                       |                   |
|----------------------|--|-------------------|----------------------|-------------------|-------------------------|-------------------|-----------------------|-------------------|-------------------------|-------------------|-----------------------|-------------------|-------------------------|-------------------|-------------------------|-------------------|-----------------------|-------------------|
|                      | Uniformly Distributed Load   |                   |                      |                   |                         |                   |                       |                   |                         |                   |                       |                   |                         |                   |                         |                   |                       |                   |
|                      | 7.5 kN/m<br>500 lb/ft  |                   | 11 kN/m<br>750 lb/ft |                   | 14.5 kN/m<br>1000 lb/ft |                   | 18 kN/m<br>1250 lb/ft |                   | 21.5 kN/m<br>1500 lb/ft |                   | 29 kN/m<br>2000 lb/ft |                   | 36.5 kN/m<br>2500 lb/ft |                   | 43.5 kN/m<br>3000 lb/ft |                   | 51 kN/m<br>3500 lb/ft |                   |
|                      | Bottom Reinf. Steel  | Stirrup End Dist. | Bottom Reinf. Steel  | Stirrup End Dist. | Bottom Reinf. Steel     | Stirrup End Dist. | Bottom Reinf. Steel   | Stirrup End Dist. | Bottom Reinf. Steel     | Stirrup End Dist. | Bottom Reinf. Steel   | Stirrup End Dist. | Bottom Reinf. Steel     | Stirrup End Dist. | Bottom Reinf. Steel     | Stirrup End Dist. | Bottom Reinf. Steel   | Stirrup End Dist. |
| 900 (3)              | 1-10M  | 0                 | 1-10M                | 0                 | 1-10M                   | 0                 | 1-10M                 | 0                 | 1-10M                   | 0                 | 1-10M                 | 0                 | 1-10M                   | 0                 | 1-10M                   | 0                 | 1-10M                 | 0                 |
| 1200 (4)             | 1-10M  | 0                 | 1-10M                | 0                 | 1-10M                   | 0                 | 1-10M                 | 0                 | 1-10M                   | 0                 | 1-10M                 | 0                 | 1-10M                   | 0                 | 1-10M                   | 0                 | 1-10M                 | 0                 |
| 1500 (5)             | 1-10M  | 0                 | 1-10M                | 0                 | 1-10M                   | 0                 | 1-10M                 | 0                 | 1-10M                   | 0                 | 1-10M                 | 0                 | 1-10M                   | 0                 | 1-15M                   | 0                 | 1-15M                 | 400 (16)          |
| 1800 (6)             | 1-10M  | 0                 | 1-10M                | 0                 | 1-10M                   | 0                 | 1-10M                 | 0                 | 1-10M                   | 0                 | 1-15M                 | 0                 | 1-15M                   | 0                 | 1-15M                   | 800 (32)          | 1-15M                 | 800 (32)          |
| 2400 (8)             | 1-10M  | 0                 | 1-10M                | 0                 | 1-15M                   | 0                 | 1-15M                 | 0                 | 1-15M                   | 0                 | 1-20M                 | 800 (32)          | 1-20M                   | 800 (32)          | 2-15M                   | 800 (32)          | 2-15M                 | 800 (32)          |
| 3000 (10)            | 1-15M  | 0                 | 1-15M                | 0                 | 1-15M                   | 0                 | 1-20M                 | 0                 | 1-20M                   | 800 (32)          | 2-15M                 | 800 (32)          | 2-15M                   | 800 (32)          | 2-15M                   | 1200 (48)         | 2-15M                 | 1200 (48)         |
| 3600 (12)            | 1-15M  | 0                 | 1-20M                | 0                 | 1-20M                   | 0                 | 2-15M                 | 800 (32)          | 2-15M                   | 800 (32)          | 2-15M                 | 1200 (48)         | 1-15M+<br>1-20M         | 1200 (48)         | 2-20M                   | 1600 (64)         |                       |                   |
| 4200 (14)            | 1-20M  | 0                 | 2-15M                | 0                 | 2-15M                   | 800 (32)          | 2-15M                 | 800 (32)          | 2-15M                   | 1200 (48)         | 1-15M+<br>1-20M       | 1200 (48)         | 1-10M+<br>2-20M         | 1600 (64)         |                         |                   |                       |                   |
| 4800 (16)            | 2-15M  | 0                 | 2-15M                | 0                 | 2-15M                   | 800 (32)          | 1-15M+<br>1-20M       | 1200 (48)         | 2-20M                   | 1200 (48)         | 1-10M+<br>2-20M       | 1600 (64)         |                         |                   |                         |                   |                       |                   |
| 5400 (18)            | 2-15M  | 0                 | 2-15M                | 800 (32)          | 1-15M+<br>1-20M         | 1200 (48)         | 2-20M                 | 1600 (64)         | 1-10M+<br>2-20M         | 1600 (64)         | 3-20M                 | 2000 (80)         |                         |                   |                         |                   |                       |                   |
| 6000 (20)            | 2-15M  | 0                 | 1-15M+<br>1-20M      | 800 (32)          | 2-20M                   | 1600 (64)         | 1-10M+<br>2-20M       | 1600 (64)         | 3-20M                   | 2000 (80)         |                       |                   |                         |                   |                         |                   |                       |                   |

NOTES:

1. Stirrup spacing (s) and end distance are given in "mm" and "inch"
2. Do not install more than 4-20M bottom bar or equivalent combination of smaller bars.
3. Bottom reinforcement located 89mm (3.5") from bottom of lintel.
4. This table to be used in conjunction with the "Lintel Design Limitations" & "Lintel Drawing".
5. Cells with zero end distance do not require stirrups, except provide a minimum of three stirrups at each end of the lintel where  $S_{a,ICF} > 0.16$ .

# ICFMA

## INSULATING CONCRETE FORMS MANUFACTURERS ASSOCIATION



**Table L. 3. 10" Lintel Reinforcement with Uniformly Distributed Load**

| Lintel Span, mm (ft) | Lintel - 10" Thick x 8" Deep (250mm Thick x 200mm Deep), s = 3" (75mm) |                   |                     |                   |                     |                   |                     |                   |                     |                   |                     |                   |                     |                   |                     |                   |                     |                   |
|----------------------|--|-------------------|---------------------|-------------------|---------------------|-------------------|---------------------|-------------------|---------------------|-------------------|---------------------|-------------------|---------------------|-------------------|---------------------|-------------------|---------------------|-------------------|
|                      | Uniformly Distributed Load   |                   |                     |                   |                     |                   |                     |                   |                     |                   |                     |                   |                     |                   |                     |                   |                     |                   |
|                      | 7.5 kN/m   |                   | 11 kN/m             |                   | 14.5 kN/m           |                   | 18 kN/m             |                   | 21.5 kN/m           |                   | 25.5 kN/m           |                   | 29 kN/m             |                   | 33 kN/m             |                   | 36.5 kN/m           |                   |
|                      | 500 lb/ft  |                   | 750 lb/ft           |                   | 1000 lb/ft          |                   | 1250 lb/ft          |                   | 1500 lb/ft          |                   | 1750 lb/ft          |                   | 2000 lb/ft          |                   | 2250 lb/ft          |                   | 2500 lb/ft          |                   |
|                      | Bottom Reinf. Steel  | Stirrup End Dist. | Bottom Reinf. Steel | Stirrup End Dist. | Bottom Reinf. Steel | Stirrup End Dist. | Bottom Reinf. Steel | Stirrup End Dist. | Bottom Reinf. Steel | Stirrup End Dist. | Bottom Reinf. Steel | Stirrup End Dist. | Bottom Reinf. Steel | Stirrup End Dist. | Bottom Reinf. Steel | Stirrup End Dist. | Bottom Reinf. Steel | Stirrup End Dist. |
| 900 (3)              | 1-10M  | 0                 | 1-10M               | 0                 | 1-10M               | 0                 | 1-15M               | 0                 | 1-15M               | 0                 | 1-15M               | 0                 | 1-15M               | 0                 | 2-15M               | 150 (6)           | 2-15M               | 150 (6)           |
| 1200 (4)             | 1-15M  | 0                 | 1-15M               | 0                 | 1-15M               | 0                 | 1-15M               | 0                 | 1-15M               | 0                 | 1-20M               | 150 (6)           | 2-15M               | 225 (9)           |                     |                   |                     |                   |
| 1500 (5)             | 1-15M  | 0                 | 1-15M               | 0                 | 1-20M               | 0                 | 1-20M               | 150 (6)           | 2-15M               | 225 (9)           |                     |                   |                     |                   |                     |                   |                     |                   |
| 1800 (6)             | 1-15M  | 0                 | 1-20M               | 0                 | 2-15M               | 150 (6)           |                     |                   |                     |                   |                     |                   |                     |                   |                     |                   |                     |                   |
| 2400 (8)             | 2-15M  | 0                 |                     |                   |                     |                   |                     |                   |                     |                   |                     |                   |                     |                   |                     |                   |                     |                   |
| 3000 (10)            |  |                   |                     |                   |                     |                   |                     |                   |                     |                   |                     |                   |                     |                   |                     |                   |                     |                   |
| 3600 (12)            |  |                   |                     |                   |                     |                   |                     |                   |                     |                   |                     |                   |                     |                   |                     |                   |                     |                   |
| 4200 (14)            |  |                   |                     |                   |                     |                   |                     |                   |                     |                   |                     |                   |                     |                   |                     |                   |                     |                   |
| 4800 (16)            |  |                   |                     |                   |                     |                   |                     |                   |                     |                   |                     |                   |                     |                   |                     |                   |                     |                   |
| 5400 (18)            |  |                   |                     |                   |                     |                   |                     |                   |                     |                   |                     |                   |                     |                   |                     |                   |                     |                   |
| 6000 (20)            |  |                   |                     |                   |                     |                   |                     |                   |                     |                   |                     |                   |                     |                   |                     |                   |                     |                   |

NOTES:

1. Stirrup spacing (s) and end distance are given in "mm" and "inch"
2. Do not install more than 2-15M bottom bar or equivalent combination of smaller bars.
3. Bottom reinforcement located 89mm (3.5") from bottom of lintel.
4. This table to be used in conjunction with the "Lintel Design Limitations" & "Lintel Drawing".
5. Cells with zero end distance do not require stirrups, except provide a minimum of three stirrups at each end of the lintel where  $S_{a,ICF} > 0.16$ .

| Lintel Span, mm (ft) | Lintel - 10" Thick x 12" Deep (250mm Thick x 300mm Deep), s = 6" (150mm) |                   |                     |                   |                     |                   |                     |                   |                     |                   |                     |                   |                     |                   |                     |                   |                     |                   |
|----------------------|--|-------------------|---------------------|-------------------|---------------------|-------------------|---------------------|-------------------|---------------------|-------------------|---------------------|-------------------|---------------------|-------------------|---------------------|-------------------|---------------------|-------------------|
|                      | Uniformly Distributed Load   |                   |                     |                   |                     |                   |                     |                   |                     |                   |                     |                   |                     |                   |                     |                   |                     |                   |
|                      | 7.5 kN/m   |                   | 11 kN/m             |                   | 14.5 kN/m           |                   | 18 kN/m             |                   | 21.5 kN/m           |                   | 25.5 kN/m           |                   | 29 kN/m             |                   | 33 kN/m             |                   | 36.5 kN/m           |                   |
|                      | 500 lb/ft  |                   | 750 lb/ft           |                   | 1000 lb/ft          |                   | 1250 lb/ft          |                   | 1500 lb/ft          |                   | 1750 lb/ft          |                   | 2000 lb/ft          |                   | 2250 lb/ft          |                   | 2500 lb/ft          |                   |
|                      | Bottom Reinf. Steel  | Stirrup End Dist. | Bottom Reinf. Steel | Stirrup End Dist. | Bottom Reinf. Steel | Stirrup End Dist. | Bottom Reinf. Steel | Stirrup End Dist. | Bottom Reinf. Steel | Stirrup End Dist. | Bottom Reinf. Steel | Stirrup End Dist. | Bottom Reinf. Steel | Stirrup End Dist. | Bottom Reinf. Steel | Stirrup End Dist. | Bottom Reinf. Steel | Stirrup End Dist. |
| 900 (3)              | 1-10M  | 0                 | 1-10M               | 0                 | 1-10M               | 0                 | 1-10M               | 0                 | 1-10M               | 0                 | 1-10M               | 0                 | 1-10M               | 0                 | 1-15M               | 0                 | 1-15M               | 0                 |
| 1200 (4)             | 1-10M  | 0                 | 1-10M               | 0                 | 1-10M               | 0                 | 1-15M               | 0                 | 1-15M               | 0                 | 1-15M               | 0                 | 1-15M               | 0                 | 1-15M               | 300 (12)          | 1-15M               | 300 (12)          |
| 1500 (5)             | 1-10M  | 0                 | 1-15M               | 0                 | 1-15M               | 0                 | 1-15M               | 0                 | 1-15M               | 0                 | 1-15M               | 300 (12)          | 1-15M               | 300 (12)          | 1-20M               | 300 (12)          | 1-20M               | 300 (12)          |
| 1800 (6)             | 1-15M  | 0                 | 1-15M               | 0                 | 1-15M               | 0                 | 1-15M               | 0                 | 1-20M               | 300 (12)          | 1-20M               | 300 (12)          | 2-15M               | 450 (18)          | 2-15M               | 450 (18)          | 2-15M               | 450 (18)          |
| 2400 (8)             | 1-15M  | 0                 | 1-20M               | 0                 | 1-20M               | 0                 | 2-15M               | 300 (12)          | 1-15M + 1-20M       | 450 (18)          | 2-20M               | 600 (24)          | 2-20M               | 750 (30)          | 1-10M + 2-20M       | 750 (30)          |                     |                   |
| 3000 (10)            | 1-20M  | 0                 | 2-15M               | 0                 | 1-15M + 1-20M       | 450 (18)          | 1-10M + 2-20M       | 600 (24)          |                     |                   |                     |                   |                     |                   |                     |                   |                     |                   |
| 3600 (12)            | 1-15M + 1-20M  | 0                 | 2-20M               | 450 (18)          |                     |                   |                     |                   |                     |                   |                     |                   |                     |                   |                     |                   |                     |                   |
| 4200 (14)            | 1-10M + 2-20M  | 300 (12)          |                     |                   |                     |                   |                     |                   |                     |                   |                     |                   |                     |                   |                     |                   |                     |                   |
| 4800 (16)            |  |                   |                     |                   |                     |                   |                     |                   |                     |                   |                     |                   |                     |                   |                     |                   |                     |                   |
| 5400 (18)            |  |                   |                     |                   |                     |                   |                     |                   |                     |                   |                     |                   |                     |                   |                     |                   |                     |                   |
| 6000 (20)            |  |                   |                     |                   |                     |                   |                     |                   |                     |                   |                     |                   |                     |                   |                     |                   |                     |                   |

NOTES:

1. Stirrup spacing (s) and end distance are given in "mm" and "inch"
2. Do not install more than 1-10M + 2-20M bottom bar or equivalent combination of smaller bars.
3. Bottom reinforcement located 89mm (3.5") from bottom of lintel.
4. This table to be used in conjunction with the "Lintel Design Limitations" & "Lintel Drawing".
5. Cells with zero end distance do not require stirrups, except provide a minimum of three stirrups at each end of the lintel where  $S_{a,ICF} > 0.16$ .



| Lintel - 10" Thick x 16" Deep (250mm Thick x 400mm Deep), s = 8" (200mm) |                     |                   |                     |                   |                     |                   |                     |                   |                     |                   |                     |                   |                     |                   |                     |                   |                     |                   |
|--|---------------------|-------------------|---------------------|-------------------|---------------------|-------------------|---------------------|-------------------|---------------------|-------------------|---------------------|-------------------|---------------------|-------------------|---------------------|-------------------|---------------------|-------------------|
| Uniformly Distributed Load   |                     |                   |                     |                   |                     |                   |                     |                   |                     |                   |                     |                   |                     |                   |                     |                   |                     |                   |
| Lintel Span, mm (ft)   | 7.5 kN/m            |                   | 11 kN/m             |                   | 14.5 kN/m           |                   | 18 kN/m             |                   | 21.5 kN/m           |                   | 25.5 kN/m           |                   | 29 kN/m             |                   | 36.5 kN/m           |                   | 43.5 kN/m           |                   |
|  | 500 lb/ft           |                   | 750 lb/ft           |                   | 1000 lb/ft          |                   | 1250 lb/ft          |                   | 1500 lb/ft          |                   | 1750 lb/ft          |                   | 2000 lb/ft          |                   | 2500 lb/ft          |                   | 3000 lb/ft          |                   |
|  | Bottom Reinf. Steel | Stirrup End Dist. | Bottom Reinf. Steel | Stirrup End Dist. | Bottom Reinf. Steel | Stirrup End Dist. | Bottom Reinf. Steel | Stirrup End Dist. | Bottom Reinf. Steel | Stirrup End Dist. | Bottom Reinf. Steel | Stirrup End Dist. | Bottom Reinf. Steel | Stirrup End Dist. | Bottom Reinf. Steel | Stirrup End Dist. | Bottom Reinf. Steel | Stirrup End Dist. |
| 900 (3)  | 1-10M               | 0                 | 1-10M               | 0                 | 1-10M               | 0                 | 1-10M               | 0                 | 1-10M               | 0                 | 1-10M               | 0                 | 1-10M               | 0                 | 1-10M               | 0                 | 1-10M               | 0                 |
| 1200 (4)   | 1-10M               | 0                 | 1-10M               | 0                 | 1-10M               | 0                 | 1-10M               | 0                 | 1-10M               | 0                 | 1-10M               | 0                 | 1-15M               | 0                 | 1-15M               | 0                 | 1-15M               | 400 (16)          |
| 1500 (5)   | 1-10M               | 0                 | 1-10M               | 0                 | 1-10M               | 0                 | 1-15M               | 0                 | 1-15M               | 0                 | 1-15M               | 0                 | 1-15M               | 0                 | 1-20M               | 400 (16)          | 1-20M               | 400 (16)          |
| 1800 (6)   | 1-10M               | 0                 | 1-15M               | 0                 | 1-15M               | 0                 | 1-15M               | 0                 | 1-20M               | 0                 | 1-20M               | 0                 | 1-20M               | 400 (16)          | 1-20M               | 400 (16)          | 1-20M               | 600 (24)          |
| 2400 (8)   | 1-15M               | 0                 | 1-20M               | 0                 | 1-20M               | 0                 | 1-20M               | 0                 | 1-20M               | 400 (16)          | 2-15M               | 400 (16)          | 2-15M               | 600 (24)          | 1-15M + 1-20M       | 800 (32)          | 2-20M               | 800 (32)          |
| 3000 (10)  | 1-20M               | 0                 | 1-20M               | 0                 | 2-15M               | 400 (16)          | 2-15M               | 400 (16)          | 1-15M + 1-20M       | 600 (24)          | 2-20M               | 800 (32)          | 1-10M + 2-20M       | 800 (32)          | 1-15M + 2-20M       | 1000 (40)         | 1-10M + 3-20M       | 1200 (48)         |
| 3600 (12)  | 1-20M               | 0                 | 2-15M               | 0                 | 1-15M + 1-20M       | 600 (24)          | 2-20M               | 800 (32)          | 1-10M + 2-20M       | 1000 (40)         | 3-20M               | 1000 (40)         | 1-10M + 3-20M       | 1200 (48)         |                     |                   |                     |                   |
| 4200 (14)  | 2-15M               | 0                 | 2-20M               | 400 (16)          | 1-10M + 2-20M       | 800 (32)          | 3-20M               | 1000 (40)         | 1-10M + 3-20M       | 1200 (48)         |                     |                   |                     |                   |                     |                   |                     |                   |
| 4800 (16)  | 2-20M               | 0                 | 1-10M + 2-20M       | 800 (32)          | 1-10M + 3-20M       | 1200 (48)         |                     |                   |                     |                   |                     |                   |                     |                   |                     |                   |                     |                   |
| 5400 (18)  | 1-10M + 2-20M       | 400 (16)          | 1-10M + 3-20M       | 1000 (40)         |                     |                   |                     |                   |                     |                   |                     |                   |                     |                   |                     |                   |                     |                   |
| 6000 (20)  | 3-20M               | 800 (32)          |                     |                   |                     |                   |                     |                   |                     |                   |                     |                   |                     |                   |                     |                   |                     |                   |

NOTES:

1. Stirrup spacing (s) and end distance are given in "mm" and "inch"
2. Do not install more than 1-10M + 3-20M bottom bar or equivalent combination of smaller bars.
3. Bottom reinforcement located 89mm (3.5") from bottom of lintel.
4. This table to be used in conjunction with the "Lintel Design Limitations" & "Lintel Drawing".
5. Cells with zero end distance do not require stirrups, except provide a minimum of three stirrups at each end of the lintel where  $S_{a,ICF} > 0.16$ .

| Lintel - 10" Thick x 24" Deep (250mm Thick x 600mm Deep), s = 12" (300mm) |                     |                   |                     |                   |                     |                   |                     |                   |                     |                   |                     |                   |                     |                   |                     |                   |                     |                   |
|---|---------------------|-------------------|---------------------|-------------------|---------------------|-------------------|---------------------|-------------------|---------------------|-------------------|---------------------|-------------------|---------------------|-------------------|---------------------|-------------------|---------------------|-------------------|
| Uniformly Distributed Load  |                     |                   |                     |                   |                     |                   |                     |                   |                     |                   |                     |                   |                     |                   |                     |                   |                     |                   |
| Lintel Span, mm (ft)  | 7.5 kN/m            |                   | 11 kN/m             |                   | 14.5 kN/m           |                   | 18 kN/m             |                   | 21.5 kN/m           |                   | 29 kN/m             |                   | 36.5 kN/m           |                   | 43.5 kN/m           |                   | 51 kN/m             |                   |
|   | 500 lb/ft           |                   | 750 lb/ft           |                   | 1000 lb/ft          |                   | 1250 lb/ft          |                   | 1500 lb/ft          |                   | 2000 lb/ft          |                   | 2500 lb/ft          |                   | 3000 lb/ft          |                   | 3500 lb/ft          |                   |
|   | Bottom Reinf. Steel | Stirrup End Dist. | Bottom Reinf. Steel | Stirrup End Dist. | Bottom Reinf. Steel | Stirrup End Dist. | Bottom Reinf. Steel | Stirrup End Dist. | Bottom Reinf. Steel | Stirrup End Dist. | Bottom Reinf. Steel | Stirrup End Dist. | Bottom Reinf. Steel | Stirrup End Dist. | Bottom Reinf. Steel | Stirrup End Dist. | Bottom Reinf. Steel | Stirrup End Dist. |
| 900 (3)   | 1-10M               | 0                 | 1-10M               | 0                 | 1-10M               | 0                 | 1-10M               | 0                 | 1-10M               | 0                 | 1-10M               | 0                 | 1-10M               | 0                 | 1-10M               | 0                 | 1-10M               | 0                 |
| 1200 (4)  | 1-10M               | 0                 | 1-10M               | 0                 | 1-10M               | 0                 | 1-10M               | 0                 | 1-10M               | 0                 | 1-10M               | 0                 | 1-10M               | 0                 | 1-10M               | 0                 | 1-15M               | 0                 |
| 1500 (5)  | 1-10M               | 0                 | 1-10M               | 0                 | 1-10M               | 0                 | 1-10M               | 0                 | 1-10M               | 0                 | 1-15M               | 0                 | 1-15M               | 0                 | 1-15M               | 0                 | 1-15M               | 600 (24)          |
| 1800 (6)  | 1-10M               | 0                 | 1-10M               | 0                 | 1-10M               | 0                 | 1-15M               | 0                 | 1-15M               | 0                 | 1-15M               | 0                 | 1-15M               | 0                 | 1-20M               | 600 (24)          | 1-20M               | 600 (24)          |
| 2400 (8)  | 1-15M               | 0                 | 1-15M               | 0                 | 1-15M               | 0                 | 1-15M               | 0                 | 1-20M               | 0                 | 1-20M               | 600 (24)          | 2-15M               | 600 (24)          | 2-15M               | 600 (24)          | 2-15M               | 900 (36)          |
| 3000 (10)   | 1-15M               | 0                 | 1-20M               | 0                 | 1-20M               | 0                 | 2-15M               | 0                 | 2-15M               | 600 (24)          | 2-15M               | 600 (24)          | 1-15M + 1-20M       | 900 (36)          | 1-15M + 1-20M       | 900 (36)          | 2-20M               | 1200 (48)         |
| 3600 (12)   | 1-20M               | 0                 | 2-15M               | 0                 | 2-15M               | 0                 | 2-15M               | 600 (24)          | 2-15M               | 600 (24)          | 2-20M               | 900 (36)          | 1-10M + 2-20M       | 1200 (48)         | 1-15M + 2-20M       | 1200 (48)         |                     |                   |
| 4200 (14)   | 2-15M               | 0                 | 2-15M               | 0                 | 2-15M               | 600 (24)          | 1-15M + 1-20M       | 600 (24)          | 2-20M               | 900 (36)          | 1-10M + 2-20M       | 1200 (48)         | 3-20M               | 1500 (60)         |                     |                   |                     |                   |
| 4800 (16)   | 2-15M               | 0                 | 1-15M + 1-20M       | 0                 | 2-20M               | 600 (24)          | 1-10M + 2-20M       | 900 (36)          | 1-15M + 2-20M       | 1200 (48)         | 1-10M + 3-20M       | 1500 (60)         |                     |                   |                     |                   |                     |                   |
| 5400 (18)   | 1-15M + 1-20M       | 0                 | 2-20M               | 600 (24)          | 1-10M + 2-20M       | 900 (36)          | 1-15M + 2-20M       | 1200 (48)         | 1-10M + 3-20M       | 1500 (60)         |                     |                   |                     |                   |                     |                   |                     |                   |
| 6000 (20)   | 2-20M               | 0                 | 1-10M + 2-20M       | 900 (36)          | 3-20M               | 1200 (48)         | 1-15M + 3-20M       | 1500 (60)         |                     |                   |                     |                   |                     |                   |                     |                   |                     |                   |

NOTES:

1. Stirrup spacing (s) and end distance are given in "mm" and "inch"
2. Do not install more than 4-20M bottom bar or equivalent combination of smaller bars.
3. Bottom reinforcement located 89mm (3.5") from bottom of lintel.
4. This table to be used in conjunction with the "Lintel Design Limitations" & "Lintel Drawing".
5. Cells with zero end distance do not require stirrups, except provide a minimum of three stirrups at each end of the lintel where  $S_{a,ICF} > 0.16$ .



| Lintel Span, mm (ft) | Lintel - 10" Thick x 32" Deep (250mm Thick x 800mm Deep), s = 16" (400mm) |                   |                      |                   |                         |                   |                       |                   |                         |                   |                       |                   |                         |                   |                         |                   |                       |                   |
|----------------------|---|-------------------|----------------------|-------------------|-------------------------|-------------------|-----------------------|-------------------|-------------------------|-------------------|-----------------------|-------------------|-------------------------|-------------------|-------------------------|-------------------|-----------------------|-------------------|
|                      | Uniformly Distributed Load  |                   |                      |                   |                         |                   |                       |                   |                         |                   |                       |                   |                         |                   |                         |                   |                       |                   |
|                      | 7.5 kN/m<br>500 lb/ft   |                   | 11 kN/m<br>750 lb/ft |                   | 14.5 kN/m<br>1000 lb/ft |                   | 18 kN/m<br>1250 lb/ft |                   | 21.5 kN/m<br>1500 lb/ft |                   | 29 kN/m<br>2000 lb/ft |                   | 36.5 kN/m<br>2500 lb/ft |                   | 43.5 kN/m<br>3000 lb/ft |                   | 51 kN/m<br>3500 lb/ft |                   |
|                      | Bottom Reinf. Steel   | Stirrup End Dist. | Bottom Reinf. Steel  | Stirrup End Dist. | Bottom Reinf. Steel     | Stirrup End Dist. | Bottom Reinf. Steel   | Stirrup End Dist. | Bottom Reinf. Steel     | Stirrup End Dist. | Bottom Reinf. Steel   | Stirrup End Dist. | Bottom Reinf. Steel     | Stirrup End Dist. | Bottom Reinf. Steel     | Stirrup End Dist. | Bottom Reinf. Steel   | Stirrup End Dist. |
| 900 (3)              | 1-10M   | 0                 | 1-10M                | 0                 | 1-10M                   | 0                 | 1-10M                 | 0                 | 1-10M                   | 0                 | 1-10M                 | 0                 | 1-10M                   | 0                 | 1-10M                   | 0                 | 1-10M                 | 0                 |
| 1200 (4)             | 1-10M   | 0                 | 1-10M                | 0                 | 1-10M                   | 0                 | 1-10M                 | 0                 | 1-10M                   | 0                 | 1-10M                 | 0                 | 1-10M                   | 0                 | 1-10M                   | 0                 | 1-10M                 | 0                 |
| 1500 (5)             | 1-10M   | 0                 | 1-10M                | 0                 | 1-10M                   | 0                 | 1-10M                 | 0                 | 1-10M                   | 0                 | 1-10M                 | 0                 | 1-15M                   | 0                 | 1-15M                   | 0                 | 1-15M                 | 0                 |
| 1800 (6)             | 1-10M   | 0                 | 1-10M                | 0                 | 1-10M                   | 0                 | 1-10M                 | 0                 | 1-10M                   | 0                 | 1-15M                 | 0                 | 1-15M                   | 0                 | 1-15M                   | 0                 | 1-15M                 | 800 (32)          |
| 2400 (8)             | 1-10M   | 0                 | 1-10M                | 0                 | 1-15M                   | 0                 | 1-15M                 | 0                 | 1-15M                   | 0                 | 1-20M                 | 0                 | 2-15M                   | 800 (32)          | 2-15M                   | 800 (32)          | 2-15M                 | 800 (32)          |
| 3000 (10)            | 1-15M   | 0                 | 1-15M                | 0                 | 1-15M                   | 0                 | 1-20M                 | 0                 | 1-20M                   | 0                 | 2-15M                 | 800 (32)          | 2-15M                   | 800 (32)          | 2-15M                   | 800 (32)          | 1-15M + 1-20M         | 1200 (48)         |
| 3600 (12)            | 1-15M   | 0                 | 1-20M                | 0                 | 1-20M                   | 0                 | 2-15M                 | 0                 | 2-15M                   | 800 (32)          | 2-15M                 | 800 (32)          | 2-20M                   | 1200 (48)         | 2-20M                   | 1200 (48)         | 1-10M + 2-20M         | 1200 (48)         |
| 4200 (14)            | 1-20M   | 0                 | 2-15M                | 0                 | 2-15M                   | 0                 | 2-15M                 | 800 (32)          | 2-15M                   | 800 (32)          | 1-15M + 1-20M         | 1200 (48)         | 1-10M + 2-20M           | 1600 (64)         |                         |                   |                       |                   |
| 4800 (16)            | 2-15M   | 0                 | 2-15M                | 0                 | 2-15M                   | 800 (32)          | 1-15M + 1-20M         | 800 (32)          | 2-20M                   | 1200 (48)         | 1-10M + 2-20M         | 1200 (48)         | 3-20M                   | 1600 (64)         |                         |                   |                       |                   |
| 5400 (18)            | 2-15M   | 0                 | 2-15M                | 0                 | 1-15M + 1-20M           | 800 (32)          | 2-20M                 | 1200 (48)         | 1-10M + 2-20M           | 1200 (48)         | 3-20M                 | 1600 (64)         |                         |                   |                         |                   |                       |                   |
| 6000 (20)            | 2-15M   | 0                 | 1-15M + 1-20M        | 800 (32)          | 1-10M + 2-20M           | 1200 (48)         | 1-15M + 2-20M         | 1200 (48)         | 3-20M                   | 1600 (64)         | 1-15M + 3-20M         | 2000 (80)         |                         |                   |                         |                   |                       |                   |

NOTES:

1. Stirrup spacing (s) and end distance are given in "mm" and "inch"
2. Do not install more than 4-20M bottom bar or equivalent combination of smaller bars.
3. Bottom reinforcement located 89mm (3.5") from bottom of lintel.
4. This table to be used in conjunction with the "Lintel Design Limitations" & "Lintel Drawing".
5. Cells with zero end distance do not require stirrups, except provide a minimum of three stirrups at each end of the lintel where  $S_{a,ICF} > 0.16$ .

# ICFMA

## INSULATING CONCRETE FORMS MANUFACTURERS ASSOCIATION



**Table L. 4. 12" Lintel Reinforcement with Uniformly Distributed Load**

| Lintel Span, mm (ft) | Lintel - 12" Thick x 8" Deep (300mm Thick x 200mm Deep), s = 3" (75mm) |                   |                      |                   |                         |                   |                       |                   |                         |                   |                         |                   |                       |                   |                       |                   |                         |                   |
|----------------------|--|-------------------|----------------------|-------------------|-------------------------|-------------------|-----------------------|-------------------|-------------------------|-------------------|-------------------------|-------------------|-----------------------|-------------------|-----------------------|-------------------|-------------------------|-------------------|
|                      | Uniformly Distributed Load   |                   |                      |                   |                         |                   |                       |                   |                         |                   |                         |                   |                       |                   |                       |                   |                         |                   |
|                      | 7.5 kN/m<br>500 lb/ft  |                   | 11 kN/m<br>750 lb/ft |                   | 14.5 kN/m<br>1000 lb/ft |                   | 18 kN/m<br>1250 lb/ft |                   | 21.5 kN/m<br>1500 lb/ft |                   | 25.5 kN/m<br>1750 lb/ft |                   | 29 kN/m<br>2000 lb/ft |                   | 33 kN/m<br>2250 lb/ft |                   | 36.5 kN/m<br>2500 lb/ft |                   |
|                      | Bottom Reinf. Steel  | Stirrup End Dist. | Bottom Reinf. Steel  | Stirrup End Dist. | Bottom Reinf. Steel     | Stirrup End Dist. | Bottom Reinf. Steel   | Stirrup End Dist. | Bottom Reinf. Steel     | Stirrup End Dist. | Bottom Reinf. Steel     | Stirrup End Dist. | Bottom Reinf. Steel   | Stirrup End Dist. | Bottom Reinf. Steel   | Stirrup End Dist. | Bottom Reinf. Steel     | Stirrup End Dist. |
| 900 (3)              | 1-10M  | 0                 | 1-10M                | 0                 | 1-10M                   | 0                 | 1-15M                 | 0                 | 1-15M                   | 0                 | 1-15M                   | 0                 | 1-15M                 | 0                 | 1-15M                 | 0                 | 1-15M                   | 0                 |
| 1200 (4)             | 1-15M  | 0                 | 1-15M                | 0                 | 1-15M                   | 0                 | 1-15M                 | 0                 | 1-15M                   | 0                 | 1-20M                   | 0                 | 1-20M                 | 150 (6)           | 2-15M                 | 150 (6)           | 2-15M                   | 225 (9)           |
| 1500 (5)             | 1-15M  | 0                 | 1-15M                | 0                 | 1-20M                   | 0                 | 1-20M                 | 0                 | 2-15M                   | 150 (6)           | 2-15M                   | 225 (9)           | 1-15M+<br>1-20M       | 225 (9)           |                       |                   |                         |                   |
| 1800 (6)             | 1-15M  | 0                 | 1-20M                | 0                 | 2-15M                   | 0                 | 2-15M                 | 150 (6)           |                         |                   |                         |                   |                       |                   |                       |                   |                         |                   |
| 2400 (8)             | 2-15M  | 0                 |                      |                   |                         |                   |                       |                   |                         |                   |                         |                   |                       |                   |                       |                   |                         |                   |
| 3000 (10)            |  |                   |                      |                   |                         |                   |                       |                   |                         |                   |                         |                   |                       |                   |                       |                   |                         |                   |
| 3600 (12)            |  |                   |                      |                   |                         |                   |                       |                   |                         |                   |                         |                   |                       |                   |                       |                   |                         |                   |
| 4200 (14)            |  |                   |                      |                   |                         |                   |                       |                   |                         |                   |                         |                   |                       |                   |                       |                   |                         |                   |
| 4800 (16)            |  |                   |                      |                   |                         |                   |                       |                   |                         |                   |                         |                   |                       |                   |                       |                   |                         |                   |
| 5400 (18)            |  |                   |                      |                   |                         |                   |                       |                   |                         |                   |                         |                   |                       |                   |                       |                   |                         |                   |
| 6000 (20)            |  |                   |                      |                   |                         |                   |                       |                   |                         |                   |                         |                   |                       |                   |                       |                   |                         |                   |

**NOTES:**

1. Stirrup spacing (s) and end distance are given in "mm" and "inch"
2. Do not install more than 1-15M + 1-20M bottom bar or equivalent combination of smaller bars.
3. Bottom reinforcement located 89mm (3.5") from bottom of lintel.
4. This table to be used in conjunction with the "Lintel Design Limitations" & "Lintel Drawing".
5. Cells with zero end distance do not require stirrups, except provide a minimum of three stirrups at each end of the lintel where  $S_{a,ICF} > 0.16$ .

| Lintel Span, mm (ft) | Lintel - 12" Thick x 12" Deep (300mm Thick x 300mm Deep), s = 6" (150mm) |                   |                      |                   |                         |                   |                       |                   |                         |                   |                         |                   |                       |                   |                       |                   |                         |                   |
|----------------------|--|-------------------|----------------------|-------------------|-------------------------|-------------------|-----------------------|-------------------|-------------------------|-------------------|-------------------------|-------------------|-----------------------|-------------------|-----------------------|-------------------|-------------------------|-------------------|
|                      | Uniformly Distributed Load   |                   |                      |                   |                         |                   |                       |                   |                         |                   |                         |                   |                       |                   |                       |                   |                         |                   |
|                      | 7.5 kN/m<br>500 lb/ft  |                   | 11 kN/m<br>750 lb/ft |                   | 14.5 kN/m<br>1000 lb/ft |                   | 18 kN/m<br>1250 lb/ft |                   | 21.5 kN/m<br>1500 lb/ft |                   | 25.5 kN/m<br>1750 lb/ft |                   | 29 kN/m<br>2000 lb/ft |                   | 33 kN/m<br>2250 lb/ft |                   | 36.5 kN/m<br>2500 lb/ft |                   |
|                      | Bottom Reinf. Steel  | Stirrup End Dist. | Bottom Reinf. Steel  | Stirrup End Dist. | Bottom Reinf. Steel     | Stirrup End Dist. | Bottom Reinf. Steel   | Stirrup End Dist. | Bottom Reinf. Steel     | Stirrup End Dist. | Bottom Reinf. Steel     | Stirrup End Dist. | Bottom Reinf. Steel   | Stirrup End Dist. | Bottom Reinf. Steel   | Stirrup End Dist. | Bottom Reinf. Steel     | Stirrup End Dist. |
| 900 (3)              | 1-10M  | 0                 | 1-10M                | 0                 | 1-10M                   | 0                 | 1-10M                 | 0                 | 1-10M                   | 0                 | 1-10M                   | 0                 | 1-10M                 | 0                 | 1-15M                 | 0                 | 1-15M                   | 0                 |
| 1200 (4)             | 1-10M  | 0                 | 1-10M                | 0                 | 1-10M                   | 0                 | 1-15M                 | 0                 | 1-15M                   | 0                 | 1-15M                   | 0                 | 1-15M                 | 0                 | 1-15M                 | 0                 | 1-20M                   | 0                 |
| 1500 (5)             | 1-10M  | 0                 | 1-15M                | 0                 | 1-15M                   | 0                 | 1-15M                 | 0                 | 1-15M                   | 0                 | 1-20M                   | 0                 | 1-20M                 | 0                 | 1-20M                 | 300 (12)          | 1-20M                   | 300 (12)          |
| 1800 (6)             | 1-15M  | 0                 | 1-15M                | 0                 | 1-20M                   | 0                 | 1-20M                 | 0                 | 1-20M                   | 0                 | 1-20M                   | 300 (12)          | 2-15M                 | 300 (12)          | 2-15M                 | 300 (12)          | 2-15M                   | 450 (18)          |
| 2400 (8)             | 1-20M  | 0                 | 1-20M                | 0                 | 1-20M                   | 0                 | 2-15M                 | 300 (12)          | 1-15M+<br>1-20M         | 300 (12)          | 1-15M+<br>1-20M         | 450 (18)          | 2-20M                 | 600 (24)          | 1-10M+<br>2-20M       | 600 (24)          | 1-15M+<br>2-20M         | 750 (30)          |
| 3000 (10)            | 1-20M  | 0                 | 2-15M                | 0                 | 1-15M+<br>1-20M         | 300 (12)          | 2-20M                 | 450 (18)          | 1-15M+<br>2-20M         | 600 (24)          | 3-20M                   | 750 (30)          |                       |                   |                       |                   |                         |                   |
| 3600 (12)            | 2-15M  | 0                 | 2-20M                | 300 (12)          | 1-15M+<br>2-20M         | 600 (24)          |                       |                   |                         |                   |                         |                   |                       |                   |                       |                   |                         |                   |
| 4200 (14)            | 2-20M  | 0                 | 3-20M                | 450 (18)          |                         |                   |                       |                   |                         |                   |                         |                   |                       |                   |                       |                   |                         |                   |
| 4800 (16)            |  |                   |                      |                   |                         |                   |                       |                   |                         |                   |                         |                   |                       |                   |                       |                   |                         |                   |
| 5400 (18)            |  |                   |                      |                   |                         |                   |                       |                   |                         |                   |                         |                   |                       |                   |                       |                   |                         |                   |
| 6000 (20)            |  |                   |                      |                   |                         |                   |                       |                   |                         |                   |                         |                   |                       |                   |                       |                   |                         |                   |

**NOTES:**

1. Stirrup spacing (s) and end distance are given in "mm" and "inch"
2. Do not install more than 3-20M bottom bar or equivalent combination of smaller bars.
3. Bottom reinforcement located 89mm (3.5") from bottom of lintel.
4. This table to be used in conjunction with the "Lintel Design Limitations" & "Lintel Drawing".
5. Cells with zero end distance do not require stirrups, except provide a minimum of three stirrups at each end of the lintel where  $S_{a,ICF} > 0.16$ .



| Lintel - 12" Thick x 16" Deep (300mm Thick x 400mm Deep), s = 8" (200mm) |                     |                   |                     |                   |                     |                   |                     |                   |                     |                   |                     |                   |                     |                   |                     |                   |                     |                   |
|--|---------------------|-------------------|---------------------|-------------------|---------------------|-------------------|---------------------|-------------------|---------------------|-------------------|---------------------|-------------------|---------------------|-------------------|---------------------|-------------------|---------------------|-------------------|
| Uniformly Distributed Load   |                     |                   |                     |                   |                     |                   |                     |                   |                     |                   |                     |                   |                     |                   |                     |                   |                     |                   |
| Lintel Span, mm (ft)   | 7.5 kN/m            |                   | 11 kN/m             |                   | 14.5 kN/m           |                   | 18 kN/m             |                   | 21.5 kN/m           |                   | 25.5 kN/m           |                   | 29 kN/m             |                   | 36.5 kN/m           |                   | 43.5 kN/m           |                   |
|  | 500 lb/ft           |                   | 750 lb/ft           |                   | 1000 lb/ft          |                   | 1250 lb/ft          |                   | 1500 lb/ft          |                   | 1750 lb/ft          |                   | 2000 lb/ft          |                   | 2500 lb/ft          |                   | 3000 lb/ft          |                   |
|  | Bottom Reinf. Steel | Stirrup End Dist. | Bottom Reinf. Steel | Stirrup End Dist. | Bottom Reinf. Steel | Stirrup End Dist. | Bottom Reinf. Steel | Stirrup End Dist. | Bottom Reinf. Steel | Stirrup End Dist. | Bottom Reinf. Steel | Stirrup End Dist. | Bottom Reinf. Steel | Stirrup End Dist. | Bottom Reinf. Steel | Stirrup End Dist. | Bottom Reinf. Steel | Stirrup End Dist. |
| 900 (3)  | 1-10M               | 0                 | 1-10M               | 0                 | 1-10M               | 0                 | 1-10M               | 0                 | 1-10M               | 0                 | 1-10M               | 0                 | 1-10M               | 0                 | 1-10M               | 0                 | 1-10M               | 0                 |
| 1200 (4)   | 1-10M               | 0                 | 1-10M               | 0                 | 1-10M               | 0                 | 1-10M               | 0                 | 1-10M               | 0                 | 1-10M               | 0                 | 1-15M               | 0                 | 1-15M               | 0                 | 1-15M               | 0                 |
| 1500 (5)   | 1-10M               | 0                 | 1-10M               | 0                 | 1-10M               | 0                 | 1-15M               | 0                 | 1-15M               | 0                 | 1-15M               | 0                 | 1-15M               | 0                 | 1-20M               | 0                 | 1-20M               | 400 (16)          |
| 1800 (6)   | 1-10M               | 0                 | 1-15M               | 0                 | 1-15M               | 0                 | 1-15M               | 0                 | 1-20M               | 0                 | 1-20M               | 0                 | 1-20M               | 0                 | 1-20M               | 400 (16)          | 1-20M               | 400 (16)          |
| 2400 (8)   | 1-15M               | 0                 | 1-20M               | 0                 | 1-20M               | 0                 | 1-20M               | 0                 | 1-20M               | 0                 | 2-15M               | 400 (16)          | 2-15M               | 400 (16)          | 1-15M + 1-20M       | 600 (24)          | 2-20M               | 800 (32)          |
| 3000 (10)  | 1-20M               | 0                 | 1-20M               | 0                 | 2-15M               | 0                 | 2-15M               | 400 (16)          | 1-15M + 1-20M       | 400 (16)          | 2-20M               | 600 (24)          | 2-20M               | 800 (32)          | 1-15M + 2-20M       | 1000 (40)         | 1-10M + 3-20M       | 1000 (40)         |
| 3600 (12)  | 1-20M               | 0                 | 2-15M               | 0                 | 1-15M + 1-20M       | 400 (16)          | 2-20M               | 600 (24)          | 1-10M + 2-20M       | 800 (32)          | 1-15M + 2-20M       | 1000 (40)         | 1-10M + 3-20M       | 1000 (40)         | 4-20M               | 1200 (48)         |                     |                   |
| 4200 (14)  | 2-15M               | 0                 | 2-20M               | 0                 | 1-10M + 2-20M       | 600 (24)          | 1-15M + 2-20M       | 800 (32)          | 1-10M + 3-20M       | 1000 (40)         | 4-20M               | 1200 (48)         |                     |                   |                     |                   |                     |                   |
| 4800 (16)  | 2-20M               | 0                 | 1-10M + 2-20M       | 400 (16)          | 1-10M + 3-20M       | 800 (32)          | 4-20M               | 1200 (48)         |                     |                   |                     |                   |                     |                   |                     |                   |                     |                   |
| 5400 (18)  | 1-10M + 2-20M       | 0                 | 1-10M + 3-20M       | 800 (32)          |                     |                   |                     |                   |                     |                   |                     |                   |                     |                   |                     |                   |                     |                   |
| 6000 (20)  | 3-20M               | 400 (16)          |                     |                   |                     |                   |                     |                   |                     |                   |                     |                   |                     |                   |                     |                   |                     |                   |

NOTES:

1. Stirrup spacing (s) and end distance are given in "mm" and "inch"
2. Do not install more than 4-20M bottom bar or equivalent combination of smaller bars.
3. Bottom reinforcement located 89mm (3.5") from bottom of lintel.
4. This table to be used in conjunction with the "Lintel Design Limitations" & "Lintel Drawing".
5. Cells with zero end distance do not require stirrups, except provide a minimum of three stirrups at each end of the lintel where  $S_{a,ICF} > 0.16$ .

| Lintel - 12" Thick x 24" Deep (300mm Thick x 600mm Deep), s = 12" (300mm) |                     |                   |                     |                   |                     |                   |                     |                   |                     |                   |                     |                   |                     |                   |                     |                   |                     |                   |
|---|---------------------|-------------------|---------------------|-------------------|---------------------|-------------------|---------------------|-------------------|---------------------|-------------------|---------------------|-------------------|---------------------|-------------------|---------------------|-------------------|---------------------|-------------------|
| Uniformly Distributed Load  |                     |                   |                     |                   |                     |                   |                     |                   |                     |                   |                     |                   |                     |                   |                     |                   |                     |                   |
| Lintel Span, mm (ft)  | 7.5 kN/m            |                   | 11 kN/m             |                   | 14.5 kN/m           |                   | 18 kN/m             |                   | 21.5 kN/m           |                   | 29 kN/m             |                   | 36.5 kN/m           |                   | 43.5 kN/m           |                   | 51 kN/m             |                   |
|   | 500 lb/ft           |                   | 750 lb/ft           |                   | 1000 lb/ft          |                   | 1250 lb/ft          |                   | 1500 lb/ft          |                   | 2000 lb/ft          |                   | 2500 lb/ft          |                   | 3000 lb/ft          |                   | 3500 lb/ft          |                   |
|   | Bottom Reinf. Steel | Stirrup End Dist. | Bottom Reinf. Steel | Stirrup End Dist. | Bottom Reinf. Steel | Stirrup End Dist. | Bottom Reinf. Steel | Stirrup End Dist. | Bottom Reinf. Steel | Stirrup End Dist. | Bottom Reinf. Steel | Stirrup End Dist. | Bottom Reinf. Steel | Stirrup End Dist. | Bottom Reinf. Steel | Stirrup End Dist. | Bottom Reinf. Steel | Stirrup End Dist. |
| 900 (3)   | 1-10M               | 0                 | 1-10M               | 0                 | 1-10M               | 0                 | 1-10M               | 0                 | 1-10M               | 0                 | 1-10M               | 0                 | 1-10M               | 0                 | 1-10M               | 0                 | 1-10M               | 0                 |
| 1200 (4)  | 1-10M               | 0                 | 1-10M               | 0                 | 1-10M               | 0                 | 1-10M               | 0                 | 1-10M               | 0                 | 1-10M               | 0                 | 1-10M               | 0                 | 1-10M               | 0                 | 1-15M               | 0                 |
| 1500 (5)  | 1-10M               | 0                 | 1-10M               | 0                 | 1-10M               | 0                 | 1-10M               | 0                 | 1-10M               | 0                 | 1-15M               | 0                 | 1-15M               | 0                 | 1-15M               | 0                 | 1-15M               | 0                 |
| 1800 (6)  | 1-10M               | 0                 | 1-10M               | 0                 | 1-10M               | 0                 | 1-15M               | 0                 | 1-15M               | 0                 | 1-15M               | 0                 | 1-15M               | 0                 | 1-20M               | 0                 | 1-20M               | 600 (24)          |
| 2400 (8)  | 1-15M               | 0                 | 1-15M               | 0                 | 1-15M               | 0                 | 1-15M               | 0                 | 1-20M               | 0                 | 1-20M               | 0                 | 2-15M               | 600 (24)          | 2-15M               | 600 (24)          | 2-15M               | 600 (24)          |
| 3000 (10)   | 1-15M               | 0                 | 1-20M               | 0                 | 1-20M               | 0                 | 2-15M               | 0                 | 2-15M               | 0                 | 2-15M               | 600 (24)          | 1-15M + 1-20M       | 600 (24)          | 1-15M + 1-20M       | 900 (36)          | 2-20M               | 900 (36)          |
| 3600 (12)   | 1-20M               | 0                 | 2-15M               | 0                 | 2-15M               | 0                 | 2-15M               | 0                 | 2-15M               | 600 (24)          | 2-20M               | 900 (36)          | 1-10M + 2-20M       | 900 (36)          | 1-15M + 2-20M       | 1200 (48)         | 3-20M               | 1200 (48)         |
| 4200 (14)   | 2-15M               | 0                 | 2-15M               | 0                 | 2-15M               | 0                 | 1-15M + 1-20M       | 600 (24)          | 2-20M               | 600 (24)          | 1-10M + 2-20M       | 1200 (48)         | 3-20M               | 1200 (48)         | 1-15M + 3-20M       | 1500 (60)         |                     |                   |
| 4800 (16)   | 2-15M               | 0                 | 1-15M + 1-20M       | 0                 | 2-20M               | 600 (24)          | 1-10M + 2-20M       | 600 (24)          | 1-15M + 2-20M       | 900 (36)          | 1-10M + 3-20M       | 1500 (60)         |                     |                   |                     |                   |                     |                   |
| 5400 (18)   | 1-15M + 1-20M       | 0                 | 2-20M               | 0                 | 1-10M + 2-20M       | 600 (24)          | 3-20M               | 900 (36)          | 1-10M + 3-20M       | 1200 (48)         |                     |                   |                     |                   |                     |                   |                     |                   |
| 6000 (20)   | 2-20M               | 0                 | 1-10M + 2-20M       | 600 (24)          | 3-20M               | 900 (36)          | 1-15M + 3-20M       | 1200 (48)         |                     |                   |                     |                   |                     |                   |                     |                   |                     |                   |

NOTES:

1. Stirrup spacing (s) and end distance are given in "mm" and "inch"
2. Do not install more than 4-20M bottom bar or equivalent combination of smaller bars.
3. Bottom reinforcement located 89mm (3.5") from bottom of lintel.
4. This table to be used in conjunction with the "Lintel Design Limitations" & "Lintel Drawing".
5. Cells with zero end distance do not require stirrups, except provide a minimum of three stirrups at each end of the lintel where  $S_{a,ICF} > 0.16$ .



| Lintel Span, mm (ft) | Lintel - 12" Thick x 32" Deep (300mm Thick x 800mm Deep), s = 16" (400mm) |                   |                     |                   |                     |                   |                     |                   |                     |                   |                     |                   |                     |                   |                     |                   |                     |                   |
|----------------------|---|-------------------|---------------------|-------------------|---------------------|-------------------|---------------------|-------------------|---------------------|-------------------|---------------------|-------------------|---------------------|-------------------|---------------------|-------------------|---------------------|-------------------|
|                      | Uniformly Distributed Load  |                   |                     |                   |                     |                   |                     |                   |                     |                   |                     |                   |                     |                   |                     |                   |                     |                   |
|                      | 7.5 kN/m  |                   | 11 kN/m             |                   | 14.5 kN/m           |                   | 18 kN/m             |                   | 21.5 kN/m           |                   | 29 kN/m             |                   | 36.5 kN/m           |                   | 43.5 kN/m           |                   | 51 kN/m             |                   |
|                      | 500 lb/ft   |                   | 750 lb/ft           |                   | 1000 lb/ft          |                   | 1250 lb/ft          |                   | 1500 lb/ft          |                   | 2000 lb/ft          |                   | 2500 lb/ft          |                   | 3000 lb/ft          |                   | 3500 lb/ft          |                   |
|                      | Bottom Reinf. Steel   | Stirrup End Dist. | Bottom Reinf. Steel | Stirrup End Dist. | Bottom Reinf. Steel | Stirrup End Dist. | Bottom Reinf. Steel | Stirrup End Dist. | Bottom Reinf. Steel | Stirrup End Dist. | Bottom Reinf. Steel | Stirrup End Dist. | Bottom Reinf. Steel | Stirrup End Dist. | Bottom Reinf. Steel | Stirrup End Dist. | Bottom Reinf. Steel | Stirrup End Dist. |
| 900 (3)              | 1-10M   | 0                 | 1-10M               | 0                 | 1-10M               | 0                 | 1-10M               | 0                 | 1-10M               | 0                 | 1-10M               | 0                 | 1-10M               | 0                 | 1-10M               | 0                 | 1-10M               | 0                 |
| 1200 (4)             | 1-10M   | 0                 | 1-10M               | 0                 | 1-10M               | 0                 | 1-10M               | 0                 | 1-10M               | 0                 | 1-10M               | 0                 | 1-10M               | 0                 | 1-10M               | 0                 | 1-10M               | 0                 |
| 1500 (5)             | 1-10M   | 0                 | 1-10M               | 0                 | 1-10M               | 0                 | 1-10M               | 0                 | 1-10M               | 0                 | 1-10M               | 0                 | 1-10M               | 0                 | 1-15M               | 0                 | 1-15M               | 0                 |
| 1800 (6)             | 1-10M   | 0                 | 1-10M               | 0                 | 1-10M               | 0                 | 1-10M               | 0                 | 1-10M               | 0                 | 1-15M               | 0                 | 1-15M               | 0                 | 1-15M               | 0                 | 1-15M               | 0                 |
| 2400 (8)             | 1-10M   | 0                 | 1-15M               | 0                 | 1-15M               | 0                 | 1-15M               | 0                 | 1-15M               | 0                 | 1-20M               | 0                 | 1-20M               | 0                 | 2-15M               | 800 (32)          | 2-15M               | 800 (32)          |
| 3000 (10)            | 1-15M   | 0                 | 1-15M               | 0                 | 1-15M               | 0                 | 1-20M               | 0                 | 1-20M               | 0                 | 2-15M               | 0                 | 2-15M               | 800 (32)          | 1-15M + 1-20M       | 800 (32)          | 1-15M + 1-20M       | 800 (32)          |
| 3600 (12)            | 1-15M   | 0                 | 1-20M               | 0                 | 1-20M               | 0                 | 2-15M               | 0                 | 2-15M               | 0                 | 1-15M + 1-20M       | 800 (32)          | 1-15M + 1-20M       | 800 (32)          | 2-20M               | 1200 (48)         | 1-10M + 2-20M       | 1200 (48)         |
| 4200 (14)            | 1-20M   | 0                 | 2-15M               | 0                 | 2-15M               | 0                 | 1-15M + 1-20M       | 0                 | 1-15M + 1-20M       | 800 (32)          | 2-20M               | 800 (32)          | 1-10M + 2-20M       | 1200 (48)         | 1-10M + 2-20M       | 1200 (48)         |                     |                   |
| 4800 (16)            | 2-15M   | 0                 | 1-15M + 1-20M       | 0                 | 1-15M + 1-20M       | 0                 | 1-15M + 1-20M       | 800 (32)          | 2-20M               | 800 (32)          | 1-10M + 2-20M       | 1200 (48)         | 3-20M               | 1600 (64)         |                     |                   |                     |                   |
| 5400 (18)            | 1-15M + 1-20M   | 0                 | 1-15M + 1-20M       | 0                 | 1-15M + 1-20M       | 0                 | 2-20M               | 800 (32)          | 1-10M + 2-20M       | 1200 (48)         | 3-20M               | 1600 (64)         | 1-15M + 3-20M       | 1600 (64)         |                     |                   |                     |                   |
| 6000 (20)            | 1-15M + 1-20M   | 0                 | 2-20M               | 0                 | 1-10M + 2-20M       | 800 (32)          | 1-15M + 2-20M       | 1200 (48)         | 3-20M               | 1200 (48)         | 1-15M + 3-20M       | 1600 (64)         |                     |                   |                     |                   |                     |                   |

NOTES:

1. Stirrup spacing (s) and end distance are given in "mm" and "inch"
2. Do not install more than 4-20M bottom bar or equivalent combination of smaller bars.
3. Bottom reinforcement located 89mm (3.5") from bottom of lintel.
4. This table to be used in conjunction with the "Lintel Design Limitations" & "Lintel Drawing".
5. Cells with zero end distance do not require stirrups, except provide a minimum of three stirrups at each end of the lintel where  $S_{a,ICF} > 0.16$ .

# ICFMA

## INSULATING CONCRETE FORMS MANUFACTURERS ASSOCIATION



**Table L. 5. 6" Lintel Reinforcement with Concentrated Load**

| Lintel Span, mm (ft) | Lintel - 6" Thick x 8" Deep (150mm Thick x 200mm Deep), s = 3" (75mm) |                     |                     |                     |                     |                     |                     |                     |                     |                     |                     |                     |                     |                     |                     |                     |                     |                     |
|----------------------|---|---------------------|---------------------|---------------------|---------------------|---------------------|---------------------|---------------------|---------------------|---------------------|---------------------|---------------------|---------------------|---------------------|---------------------|---------------------|---------------------|---------------------|
|                      | Unfactored Point Load   |                     |                     |                     |                     |                     |                     |                     |                     |                     |                     |                     |                     |                     |                     |                     |                     |                     |
|                      | 4 kN<br>800 lb  |                     | 6 kN<br>1300 lb     |                     | 8 kN<br>1700 lb     |                     | 10 kN<br>2200 lb    |                     | 12 kN<br>2600 lb    |                     | 14 kN<br>3100 lb    |                     | 16 kN<br>3500 lb    |                     | 18 kN<br>4000 lb    |                     | 20 kN<br>4400 lb    |                     |
|                      | Bottom Reinf. Steel   | Stirrups Required ? | Bottom Reinf. Steel | Stirrups Required ? | Bottom Reinf. Steel | Stirrups Required ? | Bottom Reinf. Steel | Stirrups Required ? | Bottom Reinf. Steel | Stirrups Required ? | Bottom Reinf. Steel | Stirrups Required ? | Bottom Reinf. Steel | Stirrups Required ? | Bottom Reinf. Steel | Stirrups Required ? | Bottom Reinf. Steel | Stirrups Required ? |
| 900 (3)              | 1-10M   | NO                  | 1-10M               | NO                  | 1-10M               | YES                 | 1-15M               | YES                 | 1-15M               | YES                 | 1-15M               | YES                 | 1-15M               | YES                 | 1-20M               | YES                 | 1-20M               | YES                 |
| 1200 (4)             | 1-10M   | NO                  | 1-10M               | NO                  | 1-15M               | YES                 | 1-15M               | YES                 | 1-20M               | YES                 | 1-20M               | YES                 |                     |                     |                     |                     |                     |                     |
| 1500 (5)             | 1-15M   | NO                  | 1-15M               | NO                  | 1-20M               | YES                 |                     |                     |                     |                     |                     |                     |                     |                     |                     |                     |                     |                     |
| 1800 (6)             | 1-15M   | NO                  |                     |                     |                     |                     |                     |                     |                     |                     |                     |                     |                     |                     |                     |                     |                     |                     |
| 2400 (8)             |   |                     |                     |                     |                     |                     |                     |                     |                     |                     |                     |                     |                     |                     |                     |                     |                     |                     |
| 3000 (10)            |   |                     |                     |                     |                     |                     |                     |                     |                     |                     |                     |                     |                     |                     |                     |                     |                     |                     |
| 3600 (12)            |   |                     |                     |                     |                     |                     |                     |                     |                     |                     |                     |                     |                     |                     |                     |                     |                     |                     |
| 4200 (14)            |   |                     |                     |                     |                     |                     |                     |                     |                     |                     |                     |                     |                     |                     |                     |                     |                     |                     |
| 4800 (16)            |   |                     |                     |                     |                     |                     |                     |                     |                     |                     |                     |                     |                     |                     |                     |                     |                     |                     |
| 5400 (18)            |   |                     |                     |                     |                     |                     |                     |                     |                     |                     |                     |                     |                     |                     |                     |                     |                     |                     |
| 6000 (20)            |   |                     |                     |                     |                     |                     |                     |                     |                     |                     |                     |                     |                     |                     |                     |                     |                     |                     |

**NOTES:**

1. Stirrup spacing (s) is given in "inch" and "mm"
2. Do not install more than 1-20M bottom bar or equivalent combination of smaller bars.
3. Bottom reinforcement located 89mm (3.5") from bottom of lintel.
4. This table to be used in conjunction with the "Lintel Design Limitations" & "Lintel Drawing".
5. Beams with "NO Stirrups Required" do not require stirrups, except provide a minimum of three stirrups at each end of the lintel where  $S_{a,ICF} > 0.16$ .

| Lintel Span, mm (ft) | Lintel - 6" Thick x 12" Deep (150mm Thick x 300mm Deep), s = 6" (150mm) |                     |                     |                     |                     |                     |                     |                     |                     |                     |                     |                     |                     |                     |                     |                     |                     |                     |
|----------------------|---|---------------------|---------------------|---------------------|---------------------|---------------------|---------------------|---------------------|---------------------|---------------------|---------------------|---------------------|---------------------|---------------------|---------------------|---------------------|---------------------|---------------------|
|                      | Unfactored Point Load   |                     |                     |                     |                     |                     |                     |                     |                     |                     |                     |                     |                     |                     |                     |                     |                     |                     |
|                      | 4 kN<br>800 lb  |                     | 6.5 kN<br>1400 lb   |                     | 9 kN<br>2000 lb     |                     | 11.5 kN<br>2500 lb  |                     | 14 kN<br>3100 lb    |                     | 16.5 kN<br>3700 lb  |                     | 19 kN<br>4200 lb    |                     | 21.5 kN<br>4800 lb  |                     | 24 kN<br>5300 lb    |                     |
|                      | Bottom Reinf. Steel   | Stirrups Required ? | Bottom Reinf. Steel | Stirrups Required ? | Bottom Reinf. Steel | Stirrups Required ? | Bottom Reinf. Steel | Stirrups Required ? | Bottom Reinf. Steel | Stirrups Required ? | Bottom Reinf. Steel | Stirrups Required ? | Bottom Reinf. Steel | Stirrups Required ? | Bottom Reinf. Steel | Stirrups Required ? | Bottom Reinf. Steel | Stirrups Required ? |
| 900 (3)              | 1-10M   | NO                  | 1-10M               | NO                  | 1-10M               | NO                  | 1-10M               | YES                 | 1-15M               | YES                 | 1-15M               | YES                 | 1-15M               | YES                 | 1-15M               | YES                 | 1-15M               | YES                 |
| 1200 (4)             | 1-10M   | NO                  | 1-10M               | NO                  | 1-10M               | NO                  | 1-15M               | YES                 | 1-15M               | YES                 | 1-15M               | YES                 | 1-15M               | YES                 | 1-15M               | YES                 | 1-15M               | YES                 |
| 1500 (5)             | 1-10M   | NO                  | 1-15M               | NO                  | 1-15M               | NO                  | 1-15M               | YES                 | 1-15M               | YES                 | 1-15M               | YES                 | 1-20M               | YES                 | 1-20M               | YES                 | 2-15M               | YES                 |
| 1800 (6)             | 1-15M   | NO                  | 1-15M               | NO                  | 1-15M               | NO                  | 1-15M               | YES                 | 1-20M               | YES                 | 1-20M               | YES                 | 2-15M               | YES                 |                     |                     |                     |                     |
| 2400 (8)             | 1-15M   | NO                  | 1-15M               | NO                  | 2-15M               | NO                  | 2-15M               | YES                 | 1-15M + 1-20M       | YES                 |                     |                     |                     |                     |                     |                     |                     |                     |
| 3000 (10)            | 1-20M   | NO                  | 2-15M               | NO                  |                     |                     |                     |                     |                     |                     |                     |                     |                     |                     |                     |                     |                     |                     |
| 3600 (12)            | 1-15M + 1-20M   | NO                  |                     |                     |                     |                     |                     |                     |                     |                     |                     |                     |                     |                     |                     |                     |                     |                     |
| 4200 (14)            |   |                     |                     |                     |                     |                     |                     |                     |                     |                     |                     |                     |                     |                     |                     |                     |                     |                     |
| 4800 (16)            |   |                     |                     |                     |                     |                     |                     |                     |                     |                     |                     |                     |                     |                     |                     |                     |                     |                     |
| 5400 (18)            |   |                     |                     |                     |                     |                     |                     |                     |                     |                     |                     |                     |                     |                     |                     |                     |                     |                     |
| 6000 (20)            |   |                     |                     |                     |                     |                     |                     |                     |                     |                     |                     |                     |                     |                     |                     |                     |                     |                     |

**NOTES:**

1. Stirrup spacing (s) is given in "inch" and "mm"
2. Do not install more than 1-15M + 1-20M bottom bar or equivalent combination of smaller bars.
3. Bottom reinforcement located 89mm (3.5") from bottom of lintel.
4. This table to be used in conjunction with the "Lintel Design Limitations" & "Lintel Drawing".
5. Beams with "NO Stirrups Required" do not require stirrups, except provide a minimum of three stirrups at each end of the lintel where  $S_{a,ICF} > 0.16$ .



| Lintel Span, mm (ft) | Lintel - 6" Thick x 16" Deep (150mm Thick x 400mm Deep), s = 8" (200mm) |                     |                     |                     |                     |                     |                     |                     |                     |                     |                     |                     |                     |                     |                     |                     |                     |                     |
|----------------------|---|---------------------|---------------------|---------------------|---------------------|---------------------|---------------------|---------------------|---------------------|---------------------|---------------------|---------------------|---------------------|---------------------|---------------------|---------------------|---------------------|---------------------|
|                      | Unfactored Point Load   |                     |                     |                     |                     |                     |                     |                     |                     |                     |                     |                     |                     |                     |                     |                     |                     |                     |
|                      | 4 kN<br>800 lb  |                     | 7 kN<br>1500 lb     |                     | 10 kN<br>2200 lb    |                     | 13 kN<br>2900 lb    |                     | 16 kN<br>3500 lb    |                     | 19 kN<br>4200 lb    |                     | 21 kN<br>4700 lb    |                     | 24 kN<br>5300 lb    |                     | 27 kN<br>6000 lb    |                     |
|                      | Bottom Reinf. Steel   | Stirrups Required ? | Bottom Reinf. Steel | Stirrups Required ? | Bottom Reinf. Steel | Stirrups Required ? | Bottom Reinf. Steel | Stirrups Required ? | Bottom Reinf. Steel | Stirrups Required ? | Bottom Reinf. Steel | Stirrups Required ? | Bottom Reinf. Steel | Stirrups Required ? | Bottom Reinf. Steel | Stirrups Required ? | Bottom Reinf. Steel | Stirrups Required ? |
| 900 (3)              | 1-10M   | NO                  | 1-10M               | NO                  | 1-10M               | NO                  | 1-10M               | NO                  | 1-10M               | YES                 | 1-10M               | YES                 | 1-10M               | YES                 | 1-15M               | YES                 | 1-15M               | YES                 |
| 1200 (4)             | 1-10M   | NO                  | 1-10M               | NO                  | 1-10M               | NO                  | 1-10M               | NO                  | 1-15M               | YES                 | 1-15M               | YES                 | 1-15M               | YES                 | 1-15M               | YES                 | 1-15M               | YES                 |
| 1500 (5)             | 1-10M   | NO                  | 1-10M               | NO                  | 1-10M               | NO                  | 1-15M               | YES                 | 1-15M               | YES                 | 1-15M               | YES                 | 1-15M               | YES                 | 1-15M               | YES                 | 1-20M               | YES                 |
| 1800 (6)             | 1-10M   | NO                  | 1-15M               | NO                  | 1-15M               | NO                  | 1-15M               | YES                 | 1-15M               | YES                 | 1-15M               | YES                 | 1-20M               | YES                 | 2-15M               | YES                 |                     |                     |
| 2400 (8)             | 1-15M   | NO                  | 1-15M               | NO                  | 1-15M               | NO                  | 1-20M               | YES                 | 1-20M               | YES                 | 2-15M               | YES                 | 2-20M               | YES                 |                     |                     |                     |                     |
| 3000 (10)            | 1-15M   | NO                  | 1-20M               | NO                  | 2-15M               | NO                  | 2-15M               | YES                 | 1-15M + 1-20M       | YES                 |                     |                     |                     |                     |                     |                     |                     |                     |
| 3600 (12)            | 1-20M   | NO                  | 2-15M               | NO                  | 1-15M + 1-20M       | NO                  | 1-10M + 2-20M       | YES                 | 1-15M + 2-20M       | YES                 |                     |                     |                     |                     |                     |                     |                     |                     |
| 4200 (14)            | 2-15M   | NO                  | 2-20M               | NO                  | 1-15M + 2-20M       | YES                 |                     |                     |                     |                     |                     |                     |                     |                     |                     |                     |                     |                     |
| 4800 (16)            | 2-20M   | NO                  | 1-15M + 2-20M       | NO                  |                     |                     |                     |                     |                     |                     |                     |                     |                     |                     |                     |                     |                     |                     |
| 5400 (18)            | 1-15M + 2-20M   | NO                  |                     |                     |                     |                     |                     |                     |                     |                     |                     |                     |                     |                     |                     |                     |                     |                     |
| 6000 (20)            |   |                     |                     |                     |                     |                     |                     |                     |                     |                     |                     |                     |                     |                     |                     |                     |                     |                     |

NOTES:

1. Stirrup spacing (s) is given in "inch" and "mm"
2. Do not install more than 1-15M + 2-20M bottom bar or equivalent combination of smaller bars.
3. Bottom reinforcement located 89mm (3.5") from bottom of lintel.
4. This table to be used in conjunction with the "Lintel Design Limitations" & "Lintel Drawing".
5. Beams with "NO Stirrups Required" do not require stirrups, except provide a minimum of three stirrups at each end of the lintel where  $S_{a,ICF} > 0.16$ .

| Lintel Span, mm (ft) | Lintel - 6" Thick x 24" Deep (150mm Thick x 600mm Deep), s = 12" (300mm) |                     |                     |                     |                     |                     |                     |                     |                     |                     |                     |                     |                     |                     |                     |                     |                     |                     |
|----------------------|--|---------------------|---------------------|---------------------|---------------------|---------------------|---------------------|---------------------|---------------------|---------------------|---------------------|---------------------|---------------------|---------------------|---------------------|---------------------|---------------------|---------------------|
|                      | Unfactored Point Load  |                     |                     |                     |                     |                     |                     |                     |                     |                     |                     |                     |                     |                     |                     |                     |                     |                     |
|                      | 4 kN<br>800 lb   |                     | 8 kN<br>1700 lb     |                     | 12 kN<br>2600 lb    |                     | 16 kN<br>3500 lb    |                     | 20 kN<br>4400 lb    |                     | 24 kN<br>5300 lb    |                     | 28 kN<br>6200 lb    |                     | 32 kN<br>7100 lb    |                     | 36 kN<br>8000 lb    |                     |
|                      | Bottom Reinf. Steel  | Stirrups Required ? | Bottom Reinf. Steel | Stirrups Required ? | Bottom Reinf. Steel | Stirrups Required ? | Bottom Reinf. Steel | Stirrups Required ? | Bottom Reinf. Steel | Stirrups Required ? | Bottom Reinf. Steel | Stirrups Required ? | Bottom Reinf. Steel | Stirrups Required ? | Bottom Reinf. Steel | Stirrups Required ? | Bottom Reinf. Steel | Stirrups Required ? |
| 900 (3)              | 1-10M  | NO                  | 1-10M               | NO                  | 1-10M               | NO                  | 1-10M               | NO                  | 1-10M               | YES                 | 1-10M               | YES                 | 1-10M               | YES                 | 1-10M               | YES                 | 1-15M               | YES                 |
| 1200 (4)             | 1-10M  | NO                  | 1-10M               | NO                  | 1-10M               | NO                  | 1-10M               | NO                  | 1-10M               | YES                 | 1-10M               | YES                 | 1-15M               | YES                 | 1-15M               | YES                 | 1-15M               | YES                 |
| 1500 (5)             | 1-10M  | NO                  | 1-10M               | NO                  | 1-10M               | NO                  | 1-10M               | NO                  | 1-15M               | YES                 | 1-15M               | YES                 | 1-15M               | YES                 | 1-15M               | YES                 | 1-15M               | YES                 |
| 1800 (6)             | 1-10M  | NO                  | 1-10M               | NO                  | 1-10M               | NO                  | 1-15M               | NO                  | 1-15M               | YES                 | 1-15M               | YES                 | 1-15M               | YES                 | 1-15M               | YES                 | 1-20M               | YES                 |
| 2400 (8)             | 1-10M  | NO                  | 1-15M               | NO                  | 1-15M               | NO                  | 1-15M               | NO                  | 1-15M               | YES                 | 1-15M               | YES                 | 1-20M               | YES                 | 2-15M               | YES                 | 2-15M               | YES                 |
| 3000 (10)            | 1-15M  | NO                  | 1-15M               | NO                  | 1-15M               | NO                  | 1-20M               | YES                 | 1-20M               | YES                 | 2-15M               | YES                 | 1-15M + 1-20M       | YES                 | 2-20M               | YES                 |                     |                     |
| 3600 (12)            | 1-15M  | NO                  | 1-15M               | NO                  | 1-20M               | NO                  | 2-15M               | YES                 | 2-15M               | YES                 | 2-20M               | YES                 | 1-10M + 2-20M       | YES                 |                     |                     |                     |                     |
| 4200 (14)            | 1-20M  | NO                  | 1-20M               | NO                  | 2-15M               | NO                  | 1-15M + 1-20M       | YES                 | 2-20M               | YES                 | 1-15M + 2-20M       | YES                 |                     |                     |                     |                     |                     |                     |
| 4800 (16)            | 1-20M  | NO                  | 2-15M               | NO                  | 1-15M + 1-20M       | NO                  | 1-10M + 2-20M       | YES                 | 1-15M + 2-20M       | YES                 | 1-15M + 3-20M       | YES                 |                     |                     |                     |                     |                     |                     |
| 5400 (18)            | 2-15M  | NO                  | 2-20M               | NO                  | 1-10M + 2-20M       | YES                 | 3-20M               | YES                 | 1-15M + 3-20M       | YES                 |                     |                     |                     |                     |                     |                     |                     |                     |
| 6000 (20)            | 1-15M + 1-20M  | NO                  | 1-10M + 2-20M       | NO                  | 3-20M               | YES                 | 1-15M + 3-20M       | YES                 |                     |                     |                     |                     |                     |                     |                     |                     |                     |                     |

NOTES:

1. Stirrup spacing (s) is given in "inch" and "mm"
2. Do not install more than 4-20M bottom bar or equivalent combination of smaller bars.
3. Bottom reinforcement located 89mm (3.5") from bottom of lintel.
4. This table to be used in conjunction with the "Lintel Design Limitations" & "Lintel Drawing".
5. Beams with "NO Stirrups Required" do not require stirrups, except provide a minimum of three stirrups at each end of the lintel where  $S_{a,ICF} > 0.16$ .



| Lintel Span, mm (ft) | Lintel - 6" Thick x 32" Deep (150mm Thick x 800mm Deep), s = 16" (400mm) |                     |                     |                     |                     |                     |                     |                     |                     |                     |                     |                     |                     |                     |                     |                     |                     |                     |
|----------------------|--|---------------------|---------------------|---------------------|---------------------|---------------------|---------------------|---------------------|---------------------|---------------------|---------------------|---------------------|---------------------|---------------------|---------------------|---------------------|---------------------|---------------------|
|                      | Unfactored Point Load  |                     |                     |                     |                     |                     |                     |                     |                     |                     |                     |                     |                     |                     |                     |                     |                     |                     |
|                      | 4 kN<br>800 lb   |                     | 9 kN<br>2000 lb     |                     | 14 kN<br>3100 lb    |                     | 19 kN<br>4200 lb    |                     | 24 kN<br>5300 lb    |                     | 29 kN<br>6500 lb    |                     | 34 kN<br>7600 lb    |                     | 39 kN<br>8700 lb    |                     | 44 kN<br>9800 lb    |                     |
|                      | Bottom Reinf. Steel  | Stirrups Required ? | Bottom Reinf. Steel | Stirrups Required ? | Bottom Reinf. Steel | Stirrups Required ? | Bottom Reinf. Steel | Stirrups Required ? | Bottom Reinf. Steel | Stirrups Required ? | Bottom Reinf. Steel | Stirrups Required ? | Bottom Reinf. Steel | Stirrups Required ? | Bottom Reinf. Steel | Stirrups Required ? | Bottom Reinf. Steel | Stirrups Required ? |
| 900 (3)              | 1-10M  | NO                  | 1-10M               | NO                  | 1-10M               | NO                  | 1-10M               | NO                  | 1-10M               | YES                 | 1-10M               | YES                 | 1-10M               | YES                 | 1-10M               | YES                 | 1-10M               | YES                 |
| 1200 (4)             | 1-10M  | NO                  | 1-10M               | NO                  | 1-10M               | NO                  | 1-10M               | NO                  | 1-10M               | YES                 | 1-10M               | YES                 | 1-10M               | YES                 | 1-15M               | YES                 | 1-15M               | YES                 |
| 1500 (5)             | 1-10M  | NO                  | 1-10M               | NO                  | 1-10M               | NO                  | 1-10M               | NO                  | 1-10M               | YES                 | 1-15M               | YES                 | 1-15M               | YES                 | 1-15M               | YES                 | 1-15M               | YES                 |
| 1800 (6)             | 1-10M  | NO                  | 1-10M               | NO                  | 1-10M               | NO                  | 1-10M               | NO                  | 1-15M               | YES                 | 1-15M               | YES                 | 1-15M               | YES                 | 1-15M               | YES                 | 1-20M               | YES                 |
| 2400 (8)             | 1-10M  | NO                  | 1-10M               | NO                  | 1-15M               | NO                  | 1-15M               | NO                  | 1-15M               | YES                 | 1-20M               | YES                 | 1-20M               | YES                 | 1-20M               | YES                 | 1-15M + 1-20M       | YES                 |
| 3000 (10)            | 1-15M  | NO                  | 1-15M               | NO                  | 1-15M               | NO                  | 1-20M               | YES                 | 1-20M               | YES                 | 1-20M               | YES                 | 2-15M               | YES                 |                     |                     |                     |                     |
| 3600 (12)            | 1-15M  | NO                  | 1-20M               | NO                  | 1-20M               | NO                  | 1-20M               | YES                 | 2-15M               | YES                 | 1-15M + 1-20M       | YES                 |                     |                     |                     |                     |                     |                     |
| 4200 (14)            | 1-20M  | NO                  | 1-20M               | NO                  | 1-20M               | NO                  | 2-15M               | YES                 | 1-15M + 1-20M       | YES                 |                     |                     |                     |                     |                     |                     |                     |                     |
| 4800 (16)            | 1-20M  | NO                  | 1-20M               | NO                  | 2-15M               | NO                  | 1-15M + 1-20M       | YES                 | 1-10M + 2-20M       | YES                 |                     |                     |                     |                     |                     |                     |                     |                     |
| 5400 (18)            | 1-20M  | NO                  | 2-15M               | NO                  | 1-15M + 1-20M       | NO                  | 2-20M               | YES                 |                     |                     |                     |                     |                     |                     |                     |                     |                     |                     |
| 6000 (20)            | 2-15M  | NO                  | 1-15M + 1-20M       | NO                  | 2-20M               | YES                 | 1-10M + 2-20M       | YES                 |                     |                     |                     |                     |                     |                     |                     |                     |                     |                     |

NOTES:

1. Stirrup spacing (s) is given in "inch" and "mm"
2. Do not install more than 4-20M bottom bar or equivalent combination of smaller bars.
3. Bottom reinforcement located 89mm (3.5") from bottom of lintel.
4. This table to be used in conjunction with the "Lintel Design Limitations" & "Lintel Drawing".
5. Beams with "NO Stirrups Required" do not require stirrups, except provide a minimum of three stirrups at each end of the lintel where  $S_{a,ICF} > 0.16$ .

# ICFMA

## INSULATING CONCRETE FORMS MANUFACTURERS ASSOCIATION



**Table L. 6. 8" Lintel Reinforcement with Concentrated Load**

| Lintel Span, mm (ft) | Lintel - 8" Thick x 8" Deep (200mm Thick x 200mm Deep), s = 3" (75mm) |                     |                     |                     |                     |                     |                     |                     |                     |                     |                     |                     |                     |                     |                     |                     |                     |                     |
|----------------------|---|---------------------|---------------------|---------------------|---------------------|---------------------|---------------------|---------------------|---------------------|---------------------|---------------------|---------------------|---------------------|---------------------|---------------------|---------------------|---------------------|---------------------|
|                      | Unfactored Point Load   |                     |                     |                     |                     |                     |                     |                     |                     |                     |                     |                     |                     |                     |                     |                     |                     |                     |
|                      | 4 kN  |                     | 6 kN                |                     | 8 kN                |                     | 10 kN               |                     | 12 kN               |                     | 14 kN               |                     | 16 kN               |                     | 18 kN               |                     | 20 kN               |                     |
|                      | Bottom Reinf. Steel   | Stirrups Required ? | Bottom Reinf. Steel | Stirrups Required ? | Bottom Reinf. Steel | Stirrups Required ? | Bottom Reinf. Steel | Stirrups Required ? | Bottom Reinf. Steel | Stirrups Required ? | Bottom Reinf. Steel | Stirrups Required ? | Bottom Reinf. Steel | Stirrups Required ? | Bottom Reinf. Steel | Stirrups Required ? | Bottom Reinf. Steel | Stirrups Required ? |
| 900 (3)              | 1-10M   | NO                  | 1-10M               | NO                  | 1-10M               | NO                  | 1-15M               | YES                 | 1-15M               | YES                 | 1-15M               | YES                 | 1-15M               | YES                 | 1-20M               | YES                 | 1-20M               | YES                 |
| 1200 (4)             | 1-15M   | NO                  | 1-15M               | NO                  | 1-15M               | NO                  | 1-15M               | YES                 | 1-20M               | YES                 | 1-20M               | YES                 |                     |                     |                     |                     |                     |                     |
| 1500 (5)             | 1-15M   | NO                  | 1-15M               | NO                  | 1-20M               | NO                  | 1-20M               | YES                 |                     |                     |                     |                     |                     |                     |                     |                     |                     |                     |
| 1800 (6)             | 1-15M   | NO                  | 1-20M               | NO                  |                     |                     |                     |                     |                     |                     |                     |                     |                     |                     |                     |                     |                     |                     |
| 2400 (8)             |   |                     |                     |                     |                     |                     |                     |                     |                     |                     |                     |                     |                     |                     |                     |                     |                     |                     |
| 3000 (10)            |   |                     |                     |                     |                     |                     |                     |                     |                     |                     |                     |                     |                     |                     |                     |                     |                     |                     |
| 3600 (12)            |   |                     |                     |                     |                     |                     |                     |                     |                     |                     |                     |                     |                     |                     |                     |                     |                     |                     |
| 4200 (14)            |   |                     |                     |                     |                     |                     |                     |                     |                     |                     |                     |                     |                     |                     |                     |                     |                     |                     |
| 4800 (16)            |   |                     |                     |                     |                     |                     |                     |                     |                     |                     |                     |                     |                     |                     |                     |                     |                     |                     |
| 5400 (18)            |   |                     |                     |                     |                     |                     |                     |                     |                     |                     |                     |                     |                     |                     |                     |                     |                     |                     |
| 6000 (20)            |   |                     |                     |                     |                     |                     |                     |                     |                     |                     |                     |                     |                     |                     |                     |                     |                     |                     |

**NOTES:**

1. Stirrup spacing (s) is given in "inch" and "mm"
2. Do not install more than 1-20M bottom bar or equivalent combination of smaller bars.
3. Bottom reinforcement located 89mm (3.5") from bottom of lintel.
4. This table to be used in conjunction with the "Lintel Design Limitations" & "Lintel Drawing".
5. Beams with "NO Stirrups Required" do not require stirrups, except provide a minimum of three stirrups at each end of the lintel where  $S_{a,ICF} > 0.16$ .

| Lintel Span, mm (ft) | Lintel - 8" Thick x 12" Deep (200mm Thick x 300mm Deep), s = 6" (150mm) |                     |                     |                     |                     |                     |                     |                     |                     |                     |                     |                     |                     |                     |                     |                     |                     |                     |
|----------------------|---|---------------------|---------------------|---------------------|---------------------|---------------------|---------------------|---------------------|---------------------|---------------------|---------------------|---------------------|---------------------|---------------------|---------------------|---------------------|---------------------|---------------------|
|                      | Unfactored Point Load   |                     |                     |                     |                     |                     |                     |                     |                     |                     |                     |                     |                     |                     |                     |                     |                     |                     |
|                      | 4 kN  |                     | 6.5 kN              |                     | 9 kN                |                     | 11.5 kN             |                     | 14 kN               |                     | 16.5 kN             |                     | 19 kN               |                     | 21.5 kN             |                     | 24 kN               |                     |
|                      | Bottom Reinf. Steel   | Stirrups Required ? | Bottom Reinf. Steel | Stirrups Required ? | Bottom Reinf. Steel | Stirrups Required ? | Bottom Reinf. Steel | Stirrups Required ? | Bottom Reinf. Steel | Stirrups Required ? | Bottom Reinf. Steel | Stirrups Required ? | Bottom Reinf. Steel | Stirrups Required ? | Bottom Reinf. Steel | Stirrups Required ? | Bottom Reinf. Steel | Stirrups Required ? |
| 900 (3)              | 1-10M   | NO                  | 1-10M               | NO                  | 1-10M               | NO                  | 1-10M               | NO                  | 1-15M               | NO                  | 1-15M               | YES                 | 1-15M               | YES                 | 1-15M               | YES                 | 1-15M               | YES                 |
| 1200 (4)             | 1-10M   | NO                  | 1-10M               | NO                  | 1-10M               | NO                  | 1-15M               | NO                  | 1-15M               | YES                 | 1-15M               | YES                 | 1-15M               | YES                 | 1-15M               | YES                 | 1-15M               | YES                 |
| 1500 (5)             | 1-10M   | NO                  | 1-10M               | NO                  | 1-15M               | NO                  | 1-15M               | NO                  | 1-15M               | YES                 | 1-15M               | YES                 | 1-20M               | YES                 | 1-20M               | YES                 | 1-15M + 1-20M       | YES                 |
| 1800 (6)             | 1-15M   | NO                  | 1-15M               | NO                  | 1-15M               | NO                  | 1-15M               | NO                  | 1-20M               | YES                 | 1-20M               | YES                 | 2-15M               | YES                 | 2-15M               | YES                 | 1-15M + 1-20M       | YES                 |
| 2400 (8)             | 1-15M   | NO                  | 1-20M               | NO                  | 1-20M               | NO                  | 2-15M               | NO                  | 1-15M + 1-20M       | YES                 | 2-20M               | YES                 |                     |                     |                     |                     |                     |                     |
| 3000 (10)            | 1-20M   | NO                  | 2-15M               | NO                  | 2-20M               | NO                  |                     |                     |                     |                     |                     |                     |                     |                     |                     |                     |                     |                     |
| 3600 (12)            | 1-15M + 1-20M   | NO                  |                     |                     |                     |                     |                     |                     |                     |                     |                     |                     |                     |                     |                     |                     |                     |                     |
| 4200 (14)            |   |                     |                     |                     |                     |                     |                     |                     |                     |                     |                     |                     |                     |                     |                     |                     |                     |                     |
| 4800 (16)            |   |                     |                     |                     |                     |                     |                     |                     |                     |                     |                     |                     |                     |                     |                     |                     |                     |                     |
| 5400 (18)            |   |                     |                     |                     |                     |                     |                     |                     |                     |                     |                     |                     |                     |                     |                     |                     |                     |                     |
| 6000 (20)            |   |                     |                     |                     |                     |                     |                     |                     |                     |                     |                     |                     |                     |                     |                     |                     |                     |                     |

**NOTES:**

1. Stirrup spacing (s) is given in "inch" and "mm"
2. Do not install more than 2-20M bottom bar or equivalent combination of smaller bars.
3. Bottom reinforcement located 89mm (3.5") from bottom of lintel.
4. This table to be used in conjunction with the "Lintel Design Limitations" & "Lintel Drawing".
5. Beams with "NO Stirrups Required" do not require stirrups, except provide a minimum of three stirrups at each end of the lintel where  $S_{a,ICF} > 0.16$ .



| Lintel Span, mm (ft) | Lintel - 8" Thick x 16" Deep (200mm Thick x 400mm Deep), s = 8" (200mm) |                     |                     |                     |                     |                     |                     |                     |                     |                     |                     |                     |                     |                     |                     |                     |                     |                     |
|----------------------|---|---------------------|---------------------|---------------------|---------------------|---------------------|---------------------|---------------------|---------------------|---------------------|---------------------|---------------------|---------------------|---------------------|---------------------|---------------------|---------------------|---------------------|
|                      | Unfactored Point Load   |                     |                     |                     |                     |                     |                     |                     |                     |                     |                     |                     |                     |                     |                     |                     |                     |                     |
|                      | 4 kN<br>800 lb  |                     | 7 kN<br>1500 lb     |                     | 10 kN<br>2200 lb    |                     | 13 kN<br>2900 lb    |                     | 16 kN<br>3500 lb    |                     | 19 kN<br>4200 lb    |                     | 21 kN<br>4700 lb    |                     | 24 kN<br>5300 lb    |                     | 27 kN<br>6000 lb    |                     |
|                      | Bottom Reinf. Steel   | Stirrups Required ? | Bottom Reinf. Steel | Stirrups Required ? | Bottom Reinf. Steel | Stirrups Required ? | Bottom Reinf. Steel | Stirrups Required ? | Bottom Reinf. Steel | Stirrups Required ? | Bottom Reinf. Steel | Stirrups Required ? | Bottom Reinf. Steel | Stirrups Required ? | Bottom Reinf. Steel | Stirrups Required ? | Bottom Reinf. Steel | Stirrups Required ? |
| 900 (3)              | 1-10M   | NO                  | 1-10M               | NO                  | 1-10M               | NO                  | 1-10M               | NO                  | 1-10M               | NO                  | 1-10M               | YES                 | 1-10M               | YES                 | 1-15M               | YES                 | 1-15M               | YES                 |
| 1200 (4)             | 1-10M   | NO                  | 1-10M               | NO                  | 1-10M               | NO                  | 1-10M               | NO                  | 1-15M               | NO                  | 1-15M               | YES                 | 1-15M               | YES                 | 1-15M               | YES                 | 1-15M               | YES                 |
| 1500 (5)             | 1-10M   | NO                  | 1-10M               | NO                  | 1-10M               | NO                  | 1-15M               | NO                  | 1-15M               | NO                  | 1-15M               | YES                 | 1-15M               | YES                 | 1-15M               | YES                 | 1-20M               | YES                 |
| 1800 (6)             | 1-10M   | NO                  | 1-15M               | NO                  | 1-15M               | NO                  | 1-15M               | NO                  | 1-15M               | NO                  | 1-15M               | YES                 | 1-20M               | YES                 | 2-15M               | YES                 | 2-15M               | YES                 |
| 2400 (8)             | 1-15M   | NO                  | 1-15M               | NO                  | 1-15M               | NO                  | 1-20M               | NO                  | 1-20M               | YES                 | 2-15M               | YES                 | 1-15M + 1-20M       | YES                 | 2-20M               | YES                 |                     |                     |
| 3000 (10)            | 1-15M   | NO                  | 1-15M               | NO                  | 2-15M               | NO                  | 2-15M               | NO                  | 1-15M + 1-20M       | YES                 | 2-20M               | YES                 | 1-15M + 2-20M       | YES                 |                     |                     |                     |                     |
| 3600 (12)            | 1-20M   | NO                  | 2-15M               | NO                  | 1-15M + 1-20M       | NO                  | 2-20M               | NO                  | 1-10M + 2-20M       | YES                 |                     |                     |                     |                     |                     |                     |                     |                     |
| 4200 (14)            | 2-15M   | NO                  | 2-20M               | NO                  | 1-10M + 2-20M       | NO                  | 3-20M               | NO                  |                     |                     |                     |                     |                     |                     |                     |                     |                     |                     |
| 4800 (16)            | 2-20M   | NO                  | 1-15M + 2-20M       | NO                  |                     |                     |                     |                     |                     |                     |                     |                     |                     |                     |                     |                     |                     |                     |
| 5400 (18)            | 1-10M + 2-20M   | NO                  |                     |                     |                     |                     |                     |                     |                     |                     |                     |                     |                     |                     |                     |                     |                     |                     |
| 6000 (20)            | 3-20M   | NO                  |                     |                     |                     |                     |                     |                     |                     |                     |                     |                     |                     |                     |                     |                     |                     |                     |

NOTES:

- Stirrup spacing (s) is given in "inch" and "mm"
- Do not install more than 3-20M bottom bar or equivalent combination of smaller bars.
- Bottom reinforcement located 89mm (3.5") from bottom of lintel.
- This table to be used in conjunction with the "Lintel Design Limitations" & "Lintel Drawing".
- Beams with "NO Stirrups Required" do not require stirrups, except provide a minimum of three stirrups at each end of the lintel where  $S_{a,ICF} > 0.16$ .

| Lintel Span, mm (ft) | Lintel - 8" Thick x 24" Deep (200mm Thick x 600mm Deep), s = 12" (300mm) |                     |                     |                     |                     |                     |                     |                     |                     |                     |                     |                     |                     |                     |                     |                     |                     |                     |
|----------------------|--|---------------------|---------------------|---------------------|---------------------|---------------------|---------------------|---------------------|---------------------|---------------------|---------------------|---------------------|---------------------|---------------------|---------------------|---------------------|---------------------|---------------------|
|                      | Unfactored Point Load  |                     |                     |                     |                     |                     |                     |                     |                     |                     |                     |                     |                     |                     |                     |                     |                     |                     |
|                      | 4 kN<br>800 lb   |                     | 8 kN<br>1700 lb     |                     | 12 kN<br>2600 lb    |                     | 16 kN<br>3500 lb    |                     | 20 kN<br>4400 lb    |                     | 24 kN<br>5300 lb    |                     | 28 kN<br>6200 lb    |                     | 32 kN<br>7100 lb    |                     | 36 kN<br>8000 lb    |                     |
|                      | Bottom Reinf. Steel  | Stirrups Required ? | Bottom Reinf. Steel | Stirrups Required ? | Bottom Reinf. Steel | Stirrups Required ? | Bottom Reinf. Steel | Stirrups Required ? | Bottom Reinf. Steel | Stirrups Required ? | Bottom Reinf. Steel | Stirrups Required ? | Bottom Reinf. Steel | Stirrups Required ? | Bottom Reinf. Steel | Stirrups Required ? | Bottom Reinf. Steel | Stirrups Required ? |
| 900 (3)              | 1-10M  | NO                  | 1-10M               | NO                  | 1-10M               | NO                  | 1-10M               | NO                  | 1-10M               | NO                  | 1-10M               | NO                  | 1-10M               | YES                 | 1-10M               | YES                 | 1-15M               | YES                 |
| 1200 (4)             | 1-10M  | NO                  | 1-10M               | NO                  | 1-10M               | NO                  | 1-10M               | NO                  | 1-10M               | NO                  | 1-10M               | NO                  | 1-15M               | YES                 | 1-15M               | YES                 | 1-15M               | YES                 |
| 1500 (5)             | 1-10M  | NO                  | 1-10M               | NO                  | 1-10M               | NO                  | 1-10M               | NO                  | 1-15M               | NO                  | 1-15M               | NO                  | 1-15M               | YES                 | 1-15M               | YES                 | 1-15M               | YES                 |
| 1800 (6)             | 1-10M  | NO                  | 1-10M               | NO                  | 1-10M               | NO                  | 1-15M               | NO                  | 1-15M               | NO                  | 1-15M               | NO                  | 1-15M               | YES                 | 1-20M               | YES                 | 1-20M               | YES                 |
| 2400 (8)             | 1-10M  | NO                  | 1-15M               | NO                  | 1-15M               | NO                  | 1-15M               | NO                  | 1-20M               | NO                  | 1-20M               | YES                 | 1-20M               | YES                 | 2-15M               | YES                 | 2-15M               | YES                 |
| 3000 (10)            | 1-15M  | NO                  | 1-20M               | NO                  | 1-20M               | NO                  | 1-20M               | NO                  | 1-20M               | NO                  | 2-15M               | YES                 | 1-15M + 1-20M       | YES                 | 2-20M               | YES                 |                     |                     |
| 3600 (12)            | 1-20M  | NO                  | 1-20M               | NO                  | 1-20M               | NO                  | 2-15M               | NO                  | 2-15M               | NO                  | 1-15M + 1-20M       | YES                 | 1-10M + 2-20M       | YES                 |                     |                     |                     |                     |
| 4200 (14)            | 1-20M  | NO                  | 2-15M               | NO                  | 2-15M               | NO                  | 1-15M + 1-20M       | NO                  | 2-20M               | YES                 | 1-15M + 2-20M       | YES                 | 1-10M + 3-20M       | YES                 |                     |                     |                     |                     |
| 4800 (16)            | 2-15M  | NO                  | 2-15M               | NO                  | 2-20M               | NO                  | 1-10M + 2-20M       | NO                  | 1-15M + 2-20M       | YES                 | 1-10M + 3-20M       | YES                 |                     |                     |                     |                     |                     |                     |
| 5400 (18)            | 2-15M  | NO                  | 2-20M               | NO                  | 1-10M + 2-20M       | NO                  | 1-15M + 2-20M       | NO                  | 1-10M + 3-20M       | YES                 |                     |                     |                     |                     |                     |                     |                     |                     |
| 6000 (20)            | 1-15M + 1-20M  | NO                  | 1-10M + 2-20M       | NO                  | 3-20M               | NO                  | 1-15M + 3-20M       | NO                  |                     |                     |                     |                     |                     |                     |                     |                     |                     |                     |

NOTES:

- Stirrup spacing (s) is given in "inch" and "mm"
- Do not install more than 4-20M bottom bar or equivalent combination of smaller bars.
- Bottom reinforcement located 89mm (3.5") from bottom of lintel.
- This table to be used in conjunction with the "Lintel Design Limitations" & "Lintel Drawing".
- Beams with "NO Stirrups Required" do not require stirrups, except provide a minimum of three stirrups at each end of the lintel where  $S_{a,ICF} > 0.16$ .



| Lintel Span, mm (ft) | Lintel - 8" Thick x 32" Deep (200mm Thick x 800mm Deep), s = 16" (400mm) |                     |                     |                     |                     |                     |                     |                     |                     |                     |                     |                     |                     |                     |                     |                     |                     |                     |
|----------------------|--|---------------------|---------------------|---------------------|---------------------|---------------------|---------------------|---------------------|---------------------|---------------------|---------------------|---------------------|---------------------|---------------------|---------------------|---------------------|---------------------|---------------------|
|                      | Unfactored Point Load  |                     |                     |                     |                     |                     |                     |                     |                     |                     |                     |                     |                     |                     |                     |                     |                     |                     |
|                      | 4 kN<br>800 lb   |                     | 9 kN<br>2000 lb     |                     | 14 kN<br>3100 lb    |                     | 19 kN<br>4200 lb    |                     | 24 kN<br>5300 lb    |                     | 29 kN<br>6500 lb    |                     | 34 kN<br>7600 lb    |                     | 39 kN<br>8700 lb    |                     | 44 kN<br>9800 lb    |                     |
|                      | Bottom Reinf. Steel  | Stirrups Required ? | Bottom Reinf. Steel | Stirrups Required ? | Bottom Reinf. Steel | Stirrups Required ? | Bottom Reinf. Steel | Stirrups Required ? | Bottom Reinf. Steel | Stirrups Required ? | Bottom Reinf. Steel | Stirrups Required ? | Bottom Reinf. Steel | Stirrups Required ? | Bottom Reinf. Steel | Stirrups Required ? | Bottom Reinf. Steel | Stirrups Required ? |
| 900 (3)              | 1-10M  | NO                  | 1-10M               | NO                  | 1-10M               | NO                  | 1-10M               | NO                  | 1-10M               | NO                  | 1-10M               | NO                  | 1-10M               | YES                 | 1-10M               | YES                 | 1-10M               | YES                 |
| 1200 (4)             | 1-10M  | NO                  | 1-10M               | NO                  | 1-10M               | NO                  | 1-10M               | NO                  | 1-10M               | NO                  | 1-10M               | NO                  | 1-10M               | YES                 | 1-15M               | YES                 | 1-15M               | YES                 |
| 1500 (5)             | 1-10M  | NO                  | 1-10M               | NO                  | 1-10M               | NO                  | 1-10M               | NO                  | 1-10M               | NO                  | 1-15M               | NO                  | 1-15M               | YES                 | 1-15M               | YES                 | 1-15M               | YES                 |
| 1800 (6)             | 1-10M  | NO                  | 1-10M               | NO                  | 1-10M               | NO                  | 1-10M               | NO                  | 1-15M               | NO                  | 1-15M               | NO                  | 1-15M               | YES                 | 1-15M               | YES                 | 1-15M               | YES                 |
| 2400 (8)             | 1-10M  | NO                  | 1-10M               | NO                  | 1-15M               | NO                  | 1-15M               | NO                  | 1-15M               | NO                  | 1-20M               | YES                 | 2-15M               | YES                 | 2-15M               | YES                 | 2-15M               | YES                 |
| 3000 (10)            | 1-15M  | NO                  | 1-15M               | NO                  | 1-15M               | NO                  | 1-20M               | NO                  | 2-15M               | NO                  | 2-15M               | YES                 | 2-15M               | YES                 | 1-15M + 1-20M       | YES                 |                     |                     |
| 3600 (12)            | 1-15M  | NO                  | 1-20M               | NO                  | 1-20M               | NO                  | 2-15M               | NO                  | 2-15M               | NO                  | 1-15M + 1-20M       | YES                 | 2-20M               | YES                 |                     |                     |                     |                     |
| 4200 (14)            | 1-20M  | NO                  | 2-15M               | NO                  | 2-15M               | NO                  | 2-15M               | NO                  | 1-15M + 1-20M       | NO                  | 1-10M + 2-20M       | YES                 |                     |                     |                     |                     |                     |                     |
| 4800 (16)            | 2-15M  | NO                  | 2-15M               | NO                  | 2-15M               | NO                  | 1-15M + 1-20M       | NO                  | 1-10M + 2-20M       | YES                 |                     |                     |                     |                     |                     |                     |                     |                     |
| 5400 (18)            | 2-15M  | NO                  | 2-15M               | NO                  | 1-15M + 1-20M       | NO                  | 2-20M               | NO                  | 3-20M               | YES                 |                     |                     |                     |                     |                     |                     |                     |                     |
| 6000 (20)            | 2-15M  | NO                  | 1-15M + 1-20M       | NO                  | 2-20M               | NO                  | 1-10M + 2-20M       | NO                  |                     |                     |                     |                     |                     |                     |                     |                     |                     |                     |

NOTES:

1. Stirrup spacing (s) is given in "inch" and "mm"
2. Do not install more than 4-20M bottom bar or equivalent combination of smaller bars.
3. Bottom reinforcement located 89mm (3.5") from bottom of lintel.
4. This table to be used in conjunction with the "Lintel Design Limitations" & "Lintel Drawing".
5. Beams with "NO Stirrups Required" do not require stirrups, except provide a minimum of three stirrups at each end of the lintel where  $S_{a,ICF} > 0.16$ .

# ICFMA

## INSULATING CONCRETE FORMS MANUFACTURERS ASSOCIATION



**Table L. 7. 10" Lintel Reinforcement with Concentrated Load**

| Lintel Span, mm (ft) | Lintel - 10" Thick x 8" Deep (250mm Thick x 200mm Deep), s = 3" (75mm) |                     |                     |                     |                     |                     |                     |                     |                     |                     |                     |                     |                     |                     |                     |                     |         |     |
|----------------------|--|---------------------|---------------------|---------------------|---------------------|---------------------|---------------------|---------------------|---------------------|---------------------|---------------------|---------------------|---------------------|---------------------|---------------------|---------------------|---------|-----|
|                      | Unfactored Point Load  |                     |                     |                     |                     |                     |                     |                     |                     |                     |                     |                     |                     |                     |                     |                     |         |     |
|                      | 4 kN   |                     | 6 kN                |                     | 8 kN                |                     | 10 kN               |                     | 12 kN               |                     | 14 kN               |                     | 16 kN               |                     | 18 kN               |                     | 20 kN   |     |
|                      | 800 lb   |                     | 1300 lb             |                     | 1700 lb             |                     | 2200 lb             |                     | 2600 lb             |                     | 3100 lb             |                     | 3500 lb             |                     | 4000 lb             |                     | 4400 lb |     |
|                      | Bottom Reinf. Steel  | Stirrups Required ? | Bottom Reinf. Steel | Stirrups Required ? | Bottom Reinf. Steel | Stirrups Required ? | Bottom Reinf. Steel | Stirrups Required ? | Bottom Reinf. Steel | Stirrups Required ? | Bottom Reinf. Steel | Stirrups Required ? | Bottom Reinf. Steel | Stirrups Required ? | Bottom Reinf. Steel | Stirrups Required ? |         |     |
| 900 (3)              | 1-10M  | NO                  | 1-10M               | NO                  | 1-15M               | NO                  | 1-15M               | NO                  | 1-15M               | NO                  | 1-15M               | YES                 | 1-15M               | YES                 | 1-15M               | YES                 | 1-20M   | YES |
| 1200 (4)             | 1-15M  | NO                  | 1-15M               | NO                  | 1-15M               | NO                  | 1-15M               | NO                  | 1-15M               | NO                  | 1-20M               | YES                 | 1-20M               | YES                 | 2-15M               | YES                 | 2-15M   | YES |
| 1500 (5)             | 1-15M  | NO                  | 1-15M               | NO                  | 1-20M               | NO                  | 1-20M               | NO                  | 2-15M               | NO                  |                     |                     |                     |                     |                     |                     |         |     |
| 1800 (6)             | 1-15M  | NO                  | 1-20M               | NO                  | 2-15M               | NO                  |                     |                     |                     |                     |                     |                     |                     |                     |                     |                     |         |     |
| 2400 (8)             | 2-15M  | NO                  |                     |                     |                     |                     |                     |                     |                     |                     |                     |                     |                     |                     |                     |                     |         |     |
| 3000 (10)            |  |                     |                     |                     |                     |                     |                     |                     |                     |                     |                     |                     |                     |                     |                     |                     |         |     |
| 3600 (12)            |  |                     |                     |                     |                     |                     |                     |                     |                     |                     |                     |                     |                     |                     |                     |                     |         |     |
| 4200 (14)            |  |                     |                     |                     |                     |                     |                     |                     |                     |                     |                     |                     |                     |                     |                     |                     |         |     |
| 4800 (16)            |  |                     |                     |                     |                     |                     |                     |                     |                     |                     |                     |                     |                     |                     |                     |                     |         |     |
| 5400 (18)            |  |                     |                     |                     |                     |                     |                     |                     |                     |                     |                     |                     |                     |                     |                     |                     |         |     |
| 6000 (20)            |  |                     |                     |                     |                     |                     |                     |                     |                     |                     |                     |                     |                     |                     |                     |                     |         |     |

**NOTES:**

1. Stirrup spacing (s) is given in "inch" and "mm"
2. Do not install more than 2-15M bottom bar or equivalent combination of smaller bars.
3. Bottom reinforcement located 89mm (3.5") from bottom of lintel.
4. This table to be used in conjunction with the "Lintel Design Limitations" & "Lintel Drawing".
5. Beams with "NO Stirrups Required" do not require stirrups, except provide a minimum of three stirrups at each end of the lintel where  $S_{a,ICF} > 0.16$ .

| Lintel Span, mm (ft) | Lintel - 10" Thick x 12" Deep (250mm Thick x 300mm Deep), s = 6" (150mm) |                     |                     |                     |                     |                     |                     |                     |                     |                     |                     |                     |                     |                     |                     |                     |               |     |
|----------------------|--|---------------------|---------------------|---------------------|---------------------|---------------------|---------------------|---------------------|---------------------|---------------------|---------------------|---------------------|---------------------|---------------------|---------------------|---------------------|---------------|-----|
|                      | Unfactored Point Load  |                     |                     |                     |                     |                     |                     |                     |                     |                     |                     |                     |                     |                     |                     |                     |               |     |
|                      | 4 kN   |                     | 6.5 kN              |                     | 9 kN                |                     | 11.5 kN             |                     | 14 kN               |                     | 16.5 kN             |                     | 19 kN               |                     | 21.5 kN             |                     | 24 kN         |     |
|                      | 800 lb   |                     | 1400 lb             |                     | 2000 lb             |                     | 2500 lb             |                     | 3100 lb             |                     | 3700 lb             |                     | 4200 lb             |                     | 4800 lb             |                     | 5300 lb       |     |
|                      | Bottom Reinf. Steel  | Stirrups Required ? | Bottom Reinf. Steel | Stirrups Required ? | Bottom Reinf. Steel | Stirrups Required ? | Bottom Reinf. Steel | Stirrups Required ? | Bottom Reinf. Steel | Stirrups Required ? | Bottom Reinf. Steel | Stirrups Required ? | Bottom Reinf. Steel | Stirrups Required ? | Bottom Reinf. Steel | Stirrups Required ? |               |     |
| 900 (3)              | 1-10M  | NO                  | 1-10M               | NO                  | 1-10M               | NO                  | 1-10M               | NO                  | 1-15M               | NO                  | 1-15M               | NO                  | 1-15M               | YES                 | 1-15M               | YES                 | 1-15M         | YES |
| 1200 (4)             | 1-10M  | NO                  | 1-10M               | NO                  | 1-10M               | NO                  | 1-15M               | NO                  | 1-15M               | NO                  | 1-15M               | NO                  | 1-15M               | YES                 | 1-15M               | YES                 | 1-15M         | YES |
| 1500 (5)             | 1-10M  | NO                  | 1-15M               | NO                  | 1-15M               | NO                  | 1-15M               | NO                  | 1-15M               | NO                  | 1-15M               | NO                  | 1-20M               | YES                 | 1-20M               | YES                 | 2-15M         | YES |
| 1800 (6)             | 1-15M  | NO                  | 1-15M               | NO                  | 1-15M               | NO                  | 1-15M               | NO                  | 1-20M               | NO                  | 1-20M               | NO                  | 2-15M               | YES                 | 2-15M               | YES                 | 1-15M + 1-20M | YES |
| 2400 (8)             | 1-15M  | NO                  | 1-20M               | NO                  | 1-20M               | NO                  | 2-15M               | NO                  | 1-15M + 1-20M       | NO                  | 2-20M               | YES                 | 1-10M + 2-20M       | YES                 |                     |                     |               |     |
| 3000 (10)            | 1-20M  | NO                  | 2-15M               | NO                  | 1-15M + 1-20M       | NO                  | 1-10M + 2-20M       | NO                  |                     |                     |                     |                     |                     |                     |                     |                     |               |     |
| 3600 (12)            | 1-15M + 1-20M  | NO                  | 2-20M               | NO                  |                     |                     |                     |                     |                     |                     |                     |                     |                     |                     |                     |                     |               |     |
| 4200 (14)            | 1-10M + 2-20M  | NO                  |                     |                     |                     |                     |                     |                     |                     |                     |                     |                     |                     |                     |                     |                     |               |     |
| 4800 (16)            |  |                     |                     |                     |                     |                     |                     |                     |                     |                     |                     |                     |                     |                     |                     |                     |               |     |
| 5400 (18)            |  |                     |                     |                     |                     |                     |                     |                     |                     |                     |                     |                     |                     |                     |                     |                     |               |     |
| 6000 (20)            |  |                     |                     |                     |                     |                     |                     |                     |                     |                     |                     |                     |                     |                     |                     |                     |               |     |

**NOTES:**

1. Stirrup spacing (s) is given in "inch" and "mm"
2. Do not install more than 1-10M + 2-20M bottom bar or equivalent combination of smaller bars.
3. Bottom reinforcement located 89mm (3.5") from bottom of lintel.
4. This table to be used in conjunction with the "Lintel Design Limitations" & "Lintel Drawing".
5. Beams with "NO Stirrups Required" do not require stirrups, except provide a minimum of three stirrups at each end of the lintel where  $S_{a,ICF} > 0.16$ .



| Lintel Span, mm (ft) | Lintel - 10" Thick x 16" Deep (250mm Thick x 400mm Deep), s = 8" (200mm) |                     |                     |                     |                     |                     |                     |                     |                     |                     |                     |                     |                     |                     |                     |                     |                     |                     |
|----------------------|--|---------------------|---------------------|---------------------|---------------------|---------------------|---------------------|---------------------|---------------------|---------------------|---------------------|---------------------|---------------------|---------------------|---------------------|---------------------|---------------------|---------------------|
|                      | Unfactored Point Load  |                     |                     |                     |                     |                     |                     |                     |                     |                     |                     |                     |                     |                     |                     |                     |                     |                     |
|                      | 4 kN<br>800 lb   |                     | 7 kN<br>1500 lb     |                     | 10 kN<br>2200 lb    |                     | 13 kN<br>2900 lb    |                     | 16 kN<br>3500 lb    |                     | 19 kN<br>4200 lb    |                     | 21 kN<br>4700 lb    |                     | 24 kN<br>5300 lb    |                     | 27 kN<br>6000 lb    |                     |
|                      | Bottom Reinf. Steel  | Stirrups Required ? | Bottom Reinf. Steel | Stirrups Required ? | Bottom Reinf. Steel | Stirrups Required ? | Bottom Reinf. Steel | Stirrups Required ? | Bottom Reinf. Steel | Stirrups Required ? | Bottom Reinf. Steel | Stirrups Required ? | Bottom Reinf. Steel | Stirrups Required ? | Bottom Reinf. Steel | Stirrups Required ? | Bottom Reinf. Steel | Stirrups Required ? |
| 900 (3)              | 1-10M  | NO                  | 1-10M               | NO                  | 1-10M               | NO                  | 1-10M               | NO                  | 1-10M               | NO                  | 1-10M               | NO                  | 1-10M               | NO                  | 1-15M               | YES                 | 1-15M               | YES                 |
| 1200 (4)             | 1-10M  | NO                  | 1-10M               | NO                  | 1-10M               | NO                  | 1-10M               | NO                  | 1-15M               | NO                  | 1-15M               | NO                  | 1-15M               | NO                  | 1-15M               | YES                 | 1-15M               | YES                 |
| 1500 (5)             | 1-10M  | NO                  | 1-10M               | NO                  | 1-10M               | NO                  | 1-15M               | NO                  | 1-15M               | NO                  | 1-15M               | NO                  | 1-20M               | NO                  | 1-20M               | YES                 | 1-20M               | YES                 |
| 1800 (6)             | 1-10M  | NO                  | 1-15M               | NO                  | 1-15M               | NO                  | 1-15M               | NO                  | 1-20M               | NO                  | 1-20M               | NO                  | 1-20M               | NO                  | 2-15M               | YES                 | 2-15M               | YES                 |
| 2400 (8)             | 1-15M  | NO                  | 1-20M               | NO                  | 1-20M               | NO                  | 1-20M               | NO                  | 1-20M               | NO                  | 2-15M               | NO                  | 1-15M + 1-20M       | YES                 | 2-20M               | YES                 | 1-10M + 2-20M       | YES                 |
| 3000 (10)            | 1-20M  | NO                  | 1-20M               | NO                  | 2-15M               | NO                  | 2-15M               | NO                  | 1-15M + 1-20M       | NO                  | 2-20M               | NO                  | 1-15M + 2-20M       | YES                 | 1-10M + 3-20M       | YES                 |                     |                     |
| 3600 (12)            | 1-20M  | NO                  | 2-15M               | NO                  | 1-15M + 1-20M       | NO                  | 2-20M               | NO                  | 1-10M + 2-20M       | NO                  | 1-10M + 3-20M       | YES                 |                     |                     |                     |                     |                     |                     |
| 4200 (14)            | 2-15M  | NO                  | 2-20M               | NO                  | 1-10M + 2-20M       | NO                  | 3-20M               | NO                  | 1-15M + 3-20M       | NO                  |                     |                     |                     |                     |                     |                     |                     |                     |
| 4800 (16)            | 2-20M  | NO                  | 1-10M + 2-20M       | NO                  | 1-10M + 3-20M       | NO                  |                     |                     |                     |                     |                     |                     |                     |                     |                     |                     |                     |                     |
| 5400 (18)            | 1-10M + 2-20M  | NO                  | 1-10M + 3-20M       | NO                  |                     |                     |                     |                     |                     |                     |                     |                     |                     |                     |                     |                     |                     |                     |
| 6000 (20)            | 3-20M  | NO                  | 1-10M + 3-20M       | NO                  |                     |                     |                     |                     |                     |                     |                     |                     |                     |                     |                     |                     |                     |                     |

- NOTES:
1. Stirrup spacing (s) is given in "inch" and "mm"
  2. Do not install more than 1-10M + 3-20M bottom bar or equivalent combination of smaller bars.
  3. Bottom reinforcement located 89mm (3.5") from bottom of lintel.
  4. This table to be used in conjunction with the "Lintel Design Limitations" & "Lintel Drawing".
  5. Beams with "NO Stirrups Required" do not require stirrups, except provide a minimum of three stirrups at each end of the lintel where  $S_{a,ICF} > 0.16$ .

| Lintel Span, mm (ft) | Lintel - 10" Thick x 24" Deep (250mm Thick x 600mm Deep), s = 12" (300mm) |                     |                     |                     |                     |                     |                     |                     |                     |                     |                     |                     |                     |                     |                     |                     |                     |                     |
|----------------------|---|---------------------|---------------------|---------------------|---------------------|---------------------|---------------------|---------------------|---------------------|---------------------|---------------------|---------------------|---------------------|---------------------|---------------------|---------------------|---------------------|---------------------|
|                      | Unfactored Point Load   |                     |                     |                     |                     |                     |                     |                     |                     |                     |                     |                     |                     |                     |                     |                     |                     |                     |
|                      | 4 kN<br>800 lb  |                     | 8 kN<br>1700 lb     |                     | 12 kN<br>2600 lb    |                     | 16 kN<br>3500 lb    |                     | 20 kN<br>4400 lb    |                     | 24 kN<br>5300 lb    |                     | 28 kN<br>6200 lb    |                     | 32 kN<br>7100 lb    |                     | 36 kN<br>8000 lb    |                     |
|                      | Bottom Reinf. Steel   | Stirrups Required ? | Bottom Reinf. Steel | Stirrups Required ? | Bottom Reinf. Steel | Stirrups Required ? | Bottom Reinf. Steel | Stirrups Required ? | Bottom Reinf. Steel | Stirrups Required ? | Bottom Reinf. Steel | Stirrups Required ? | Bottom Reinf. Steel | Stirrups Required ? | Bottom Reinf. Steel | Stirrups Required ? | Bottom Reinf. Steel | Stirrups Required ? |
| 900 (3)              | 1-10M   | NO                  | 1-10M               | NO                  | 1-10M               | NO                  | 1-10M               | NO                  | 1-10M               | NO                  | 1-10M               | NO                  | 1-10M               | NO                  | 1-10M               | NO                  | 1-15M               | YES                 |
| 1200 (4)             | 1-10M   | NO                  | 1-10M               | NO                  | 1-10M               | NO                  | 1-10M               | NO                  | 1-10M               | NO                  | 1-10M               | NO                  | 1-15M               | NO                  | 1-15M               | NO                  | 1-15M               | YES                 |
| 1500 (5)             | 1-10M   | NO                  | 1-10M               | NO                  | 1-10M               | NO                  | 1-10M               | NO                  | 1-15M               | NO                  | 1-15M               | NO                  | 1-15M               | NO                  | 1-15M               | YES                 | 1-15M               | YES                 |
| 1800 (6)             | 1-10M   | NO                  | 1-10M               | NO                  | 1-10M               | NO                  | 1-15M               | NO                  | 1-15M               | NO                  | 1-15M               | NO                  | 1-15M               | NO                  | 1-20M               | YES                 | 1-20M               | YES                 |
| 2400 (8)             | 1-15M   | NO                  | 1-15M               | NO                  | 1-15M               | NO                  | 1-15M               | NO                  | 1-20M               | NO                  | 1-20M               | NO                  | 2-15M               | NO                  | 2-15M               | YES                 | 2-15M               | YES                 |
| 3000 (10)            | 1-15M   | NO                  | 1-20M               | NO                  | 1-20M               | NO                  | 2-15M               | NO                  | 2-15M               | NO                  | 2-15M               | NO                  | 1-15M + 1-20M       | NO                  | 2-20M               | YES                 | 1-10M + 2-20M       | YES                 |
| 3600 (12)            | 1-20M   | NO                  | 2-15M               | NO                  | 2-15M               | NO                  | 2-15M               | NO                  | 2-15M               | NO                  | 2-20M               | NO                  | 1-10M + 2-20M       | YES                 | 1-15M + 2-20M       | YES                 |                     |                     |
| 4200 (14)            | 2-15M   | NO                  | 2-15M               | NO                  | 2-15M               | NO                  | 1-15M + 1-20M       | NO                  | 2-20M               | NO                  | 1-10M + 2-20M       | NO                  | 3-20M               | YES                 |                     |                     |                     |                     |
| 4800 (16)            | 2-15M   | NO                  | 1-15M + 1-20M       | NO                  | 2-20M               | NO                  | 1-10M + 2-20M       | NO                  | 1-15M + 2-20M       | NO                  | 1-10M + 3-20M       | NO                  |                     |                     |                     |                     |                     |                     |
| 5400 (18)            | 1-15M + 1-20M   | NO                  | 2-20M               | NO                  | 1-10M + 2-20M       | NO                  | 1-15M + 2-20M       | NO                  | 1-10M + 3-20M       | NO                  |                     |                     |                     |                     |                     |                     |                     |                     |
| 6000 (20)            | 2-20M   | NO                  | 1-10M + 2-20M       | NO                  | 3-20M               | NO                  | 1-15M + 3-20M       | NO                  |                     |                     |                     |                     |                     |                     |                     |                     |                     |                     |

- NOTES:
1. Stirrup spacing (s) is given in "inch" and "mm"
  2. Do not install more than 4-20M bottom bar or equivalent combination of smaller bars.
  3. Bottom reinforcement located 89mm (3.5") from bottom of lintel.
  4. This table to be used in conjunction with the "Lintel Design Limitations" & "Lintel Drawing".
  5. Beams with "NO Stirrups Required" do not require stirrups, except provide a minimum of three stirrups at each end of the lintel where  $S_{a,ICF} > 0.16$ .



| Lintel Span, mm (ft) | Lintel - 10" Thick x 32" Deep (250mm Thick x 800mm Deep), s = 16" (400mm) |                     |                     |                     |                     |                     |                     |                     |                     |                     |                     |                     |                     |                     |                     |                     |                     |                     |
|----------------------|---|---------------------|---------------------|---------------------|---------------------|---------------------|---------------------|---------------------|---------------------|---------------------|---------------------|---------------------|---------------------|---------------------|---------------------|---------------------|---------------------|---------------------|
|                      | Unfactored Point Load   |                     |                     |                     |                     |                     |                     |                     |                     |                     |                     |                     |                     |                     |                     |                     |                     |                     |
|                      | 4 kN<br>800 lb  |                     | 9 kN<br>2000 lb     |                     | 14 kN<br>3100 lb    |                     | 19 kN<br>4200 lb    |                     | 24 kN<br>5300 lb    |                     | 29 kN<br>6500 lb    |                     | 34 kN<br>7600 lb    |                     | 39 kN<br>8700 lb    |                     | 44 kN<br>9800 lb    |                     |
|                      | Bottom Reinf. Steel   | Stirrups Required ? | Bottom Reinf. Steel | Stirrups Required ? | Bottom Reinf. Steel | Stirrups Required ? | Bottom Reinf. Steel | Stirrups Required ? | Bottom Reinf. Steel | Stirrups Required ? | Bottom Reinf. Steel | Stirrups Required ? | Bottom Reinf. Steel | Stirrups Required ? | Bottom Reinf. Steel | Stirrups Required ? | Bottom Reinf. Steel | Stirrups Required ? |
| 900 (3)              | 1-10M   | NO                  | 1-10M               | NO                  | 1-10M               | NO                  | 1-10M               | NO                  | 1-10M               | NO                  | 1-10M               | NO                  | 1-10M               | NO                  | 1-10M               | NO                  | 1-10M               | YES                 |
| 1200 (4)             | 1-10M   | NO                  | 1-10M               | NO                  | 1-10M               | NO                  | 1-10M               | NO                  | 1-10M               | NO                  | 1-10M               | NO                  | 1-10M               | NO                  | 1-15M               | NO                  | 1-15M               | YES                 |
| 1500 (5)             | 1-10M   | NO                  | 1-10M               | NO                  | 1-10M               | NO                  | 1-10M               | NO                  | 1-10M               | NO                  | 1-15M               | NO                  | 1-15M               | NO                  | 1-15M               | YES                 | 1-15M               | YES                 |
| 1800 (6)             | 1-10M   | NO                  | 1-10M               | NO                  | 1-10M               | NO                  | 1-10M               | NO                  | 1-15M               | NO                  | 1-15M               | NO                  | 1-15M               | NO                  | 1-15M               | YES                 | 1-20M               | YES                 |
| 2400 (8)             | 1-10M   | NO                  | 1-10M               | NO                  | 1-15M               | NO                  | 1-15M               | NO                  | 1-15M               | NO                  | 1-20M               | NO                  | 2-15M               | NO                  | 2-15M               | YES                 | 2-15M               | YES                 |
| 3000 (10)            | 1-15M   | NO                  | 1-15M               | NO                  | 1-15M               | NO                  | 1-20M               | NO                  | 2-15M               | NO                  | 2-15M               | NO                  | 2-15M               | NO                  | 1-15M + 1-20M       | YES                 | 1-15M + 1-20M       | YES                 |
| 3600 (12)            | 1-15M   | NO                  | 1-20M               | NO                  | 1-20M               | NO                  | 2-15M               | NO                  | 2-15M               | NO                  | 2-20M               | NO                  | 2-20M               | YES                 |                     |                     |                     |                     |
| 4200 (14)            | 1-20M   | NO                  | 2-15M               | NO                  | 2-15M               | NO                  | 2-15M               | NO                  | 1-15M + 1-20M       | NO                  | 1-10M + 2-20M       | NO                  | 1-15M + 2-20M       | YES                 |                     |                     |                     |                     |
| 4800 (16)            | 2-15M   | NO                  | 2-15M               | NO                  | 2-15M               | NO                  | 1-15M + 1-20M       | NO                  | 1-10M + 2-20M       | NO                  | 3-20M               | NO                  |                     |                     |                     |                     |                     |                     |
| 5400 (18)            | 2-15M   | NO                  | 2-15M               | NO                  | 1-15M + 1-20M       | NO                  | 2-20M               | NO                  | 3-20M               | NO                  |                     |                     |                     |                     |                     |                     |                     |                     |
| 6000 (20)            | 2-15M   | NO                  | 1-15M + 1-20M       | NO                  | 1-10M + 2-20M       | NO                  | 1-15M + 2-20M       | NO                  | 1-15M + 3-20M       | NO                  |                     |                     |                     |                     |                     |                     |                     |                     |

NOTES:

1. Stirrup spacing (s) is given in "inch" and "mm"
2. Do not install more than 4-20M bottom bar or equivalent combination of smaller bars.
3. Bottom reinforcement located 89mm (3.5") from bottom of lintel.
4. This table to be used in conjunction with the "Lintel Design Limitations" & "Lintel Drawing".
5. Beams with "NO Stirrups Required" do not require stirrups, except provide a minimum of three stirrups at each end of the lintel where  $S_{a,ICF} > 0.16$ .

# ICFMA

## INSULATING CONCRETE FORMS MANUFACTURERS ASSOCIATION



**Table L. 8. 12" Lintel Reinforcement with Concentrated Load**

| Lintel Span, mm (ft) | Lintel - 12" Thick x 8" Deep (300mm Thick x 200mm Deep), s = 3" (75mm) |                     |                     |                     |                     |                     |                     |                     |                     |                     |                     |                     |                     |                     |                     |                     |                     |                     |
|----------------------|--|---------------------|---------------------|---------------------|---------------------|---------------------|---------------------|---------------------|---------------------|---------------------|---------------------|---------------------|---------------------|---------------------|---------------------|---------------------|---------------------|---------------------|
|                      | Unfactored Point Load  |                     |                     |                     |                     |                     |                     |                     |                     |                     |                     |                     |                     |                     |                     |                     |                     |                     |
|                      | 4 kN<br>800 lb   |                     | 6 kN<br>1300 lb     |                     | 8 kN<br>1700 lb     |                     | 10 kN<br>2200 lb    |                     | 12 kN<br>2600 lb    |                     | 14 kN<br>3100 lb    |                     | 16 kN<br>3500 lb    |                     | 18 kN<br>4000 lb    |                     | 20 kN<br>4400 lb    |                     |
|                      | Bottom Reinf. Steel  | Stirrups Required ? | Bottom Reinf. Steel | Stirrups Required ? | Bottom Reinf. Steel | Stirrups Required ? | Bottom Reinf. Steel | Stirrups Required ? | Bottom Reinf. Steel | Stirrups Required ? | Bottom Reinf. Steel | Stirrups Required ? | Bottom Reinf. Steel | Stirrups Required ? | Bottom Reinf. Steel | Stirrups Required ? | Bottom Reinf. Steel | Stirrups Required ? |
| 900 (3)              | 1-10M  | NO                  | 1-10M               | NO                  | 1-15M               | NO                  | 1-15M               | NO                  | 1-15M               | NO                  | 1-15M               | NO                  | 1-15M               | YES                 | 1-15M               | YES                 | 1-20M               | YES                 |
| 1200 (4)             | 1-15M  | NO                  | 1-15M               | NO                  | 1-15M               | NO                  | 1-15M               | NO                  | 1-15M               | NO                  | 1-20M               | NO                  | 1-20M               | YES                 | 2-15M               | YES                 | 2-15M               | YES                 |
| 1500 (5)             | 1-15M  | NO                  | 1-15M               | NO                  | 1-20M               | NO                  | 1-20M               | NO                  | 2-15M               | NO                  | 2-15M               | NO                  | 1-15M + 1-20M       | YES                 |                     |                     |                     |                     |
| 1800 (6)             | 1-15M  | NO                  | 1-20M               | NO                  | 2-15M               | NO                  | 2-15M               | NO                  |                     |                     |                     |                     |                     |                     |                     |                     |                     |                     |
| 2400 (8)             | 2-15M  | NO                  |                     |                     |                     |                     |                     |                     |                     |                     |                     |                     |                     |                     |                     |                     |                     |                     |
| 3000 (10)            |  |                     |                     |                     |                     |                     |                     |                     |                     |                     |                     |                     |                     |                     |                     |                     |                     |                     |
| 3600 (12)            |  |                     |                     |                     |                     |                     |                     |                     |                     |                     |                     |                     |                     |                     |                     |                     |                     |                     |
| 4200 (14)            |  |                     |                     |                     |                     |                     |                     |                     |                     |                     |                     |                     |                     |                     |                     |                     |                     |                     |
| 4800 (16)            |  |                     |                     |                     |                     |                     |                     |                     |                     |                     |                     |                     |                     |                     |                     |                     |                     |                     |
| 5400 (18)            |  |                     |                     |                     |                     |                     |                     |                     |                     |                     |                     |                     |                     |                     |                     |                     |                     |                     |
| 6000 (20)            |  |                     |                     |                     |                     |                     |                     |                     |                     |                     |                     |                     |                     |                     |                     |                     |                     |                     |

NOTES:

1. Stirrup spacing (s) is given in "inch" and "mm"
2. Do not install more than 1-15M + 1-20M bottom bar or equivalent combination of smaller bars.
3. Bottom reinforcement located 89mm (3.5") from bottom of lintel.
4. This table to be used in conjunction with the "Lintel Design Limitations" & "Lintel Drawing".
5. Beams with "NO Stirrups Required" do not require stirrups, except provide a minimum of three stirrups at each end of the lintel where  $S_{a,ICF} > 0.16$ .

| Lintel Span, mm (ft) | Lintel - 12" Thick x 12" Deep (300mm Thick x 300mm Deep), s = 6" (150mm) |                     |                     |                     |                     |                     |                     |                     |                     |                     |                     |                     |                     |                     |                     |                     |                     |                     |
|----------------------|--|---------------------|---------------------|---------------------|---------------------|---------------------|---------------------|---------------------|---------------------|---------------------|---------------------|---------------------|---------------------|---------------------|---------------------|---------------------|---------------------|---------------------|
|                      | Unfactored Point Load  |                     |                     |                     |                     |                     |                     |                     |                     |                     |                     |                     |                     |                     |                     |                     |                     |                     |
|                      | 4 kN<br>800 lb   |                     | 6.5 kN<br>1400 lb   |                     | 9 kN<br>2000 lb     |                     | 11.5 kN<br>2500 lb  |                     | 14 kN<br>3100 lb    |                     | 16.5 kN<br>3700 lb  |                     | 19 kN<br>4200 lb    |                     | 21.5 kN<br>4800 lb  |                     | 24 kN<br>5300 lb    |                     |
|                      | Bottom Reinf. Steel  | Stirrups Required ? | Bottom Reinf. Steel | Stirrups Required ? | Bottom Reinf. Steel | Stirrups Required ? | Bottom Reinf. Steel | Stirrups Required ? | Bottom Reinf. Steel | Stirrups Required ? | Bottom Reinf. Steel | Stirrups Required ? | Bottom Reinf. Steel | Stirrups Required ? | Bottom Reinf. Steel | Stirrups Required ? | Bottom Reinf. Steel | Stirrups Required ? |
| 900 (3)              | 1-10M  | NO                  | 1-10M               | NO                  | 1-10M               | NO                  | 1-10M               | NO                  | 1-15M               | NO                  | 1-15M               | NO                  | 1-15M               | NO                  | 1-15M               | NO                  | 1-15M               | YES                 |
| 1200 (4)             | 1-10M  | NO                  | 1-10M               | NO                  | 1-10M               | NO                  | 1-15M               | NO                  | 1-15M               | NO                  | 1-15M               | NO                  | 1-15M               | NO                  | 1-20M               | NO                  | 1-20M               | YES                 |
| 1500 (5)             | 1-10M  | NO                  | 1-15M               | NO                  | 1-15M               | NO                  | 1-15M               | NO                  | 1-20M               | NO                  | 1-20M               | NO                  | 1-20M               | NO                  | 1-20M               | YES                 | 2-15M               | YES                 |
| 1800 (6)             | 1-15M  | NO                  | 1-15M               | NO                  | 1-20M               | NO                  | 1-20M               | NO                  | 1-20M               | NO                  | 1-20M               | NO                  | 2-15M               | NO                  | 2-15M               | YES                 | 1-15M + 1-20M       | YES                 |
| 2400 (8)             | 1-20M  | NO                  | 1-20M               | NO                  | 1-20M               | NO                  | 2-15M               | NO                  | 1-15M + 1-20M       | NO                  | 2-20M               | NO                  | 1-10M + 2-20M       | NO                  | 1-15M + 2-20M       | YES                 |                     |                     |
| 3000 (10)            | 1-20M  | NO                  | 2-15M               | NO                  | 1-15M + 1-20M       | NO                  | 2-20M               | NO                  | 1-15M + 2-20M       | NO                  |                     |                     |                     |                     |                     |                     |                     |                     |
| 3600 (12)            | 2-15M  | NO                  | 2-20M               | NO                  | 1-15M + 2-20M       | NO                  |                     |                     |                     |                     |                     |                     |                     |                     |                     |                     |                     |                     |
| 4200 (14)            | 2-20M  | NO                  | 3-20M               | NO                  |                     |                     |                     |                     |                     |                     |                     |                     |                     |                     |                     |                     |                     |                     |
| 4800 (16)            |  |                     |                     |                     |                     |                     |                     |                     |                     |                     |                     |                     |                     |                     |                     |                     |                     |                     |
| 5400 (18)            |  |                     |                     |                     |                     |                     |                     |                     |                     |                     |                     |                     |                     |                     |                     |                     |                     |                     |
| 6000 (20)            |  |                     |                     |                     |                     |                     |                     |                     |                     |                     |                     |                     |                     |                     |                     |                     |                     |                     |

NOTES:

1. Stirrup spacing (s) is given in "inch" and "mm"
2. Do not install more than 3-20M bottom bar or equivalent combination of smaller bars.
3. Bottom reinforcement located 89mm (3.5") from bottom of lintel.
4. This table to be used in conjunction with the "Lintel Design Limitations" & "Lintel Drawing".
5. Beams with "NO Stirrups Required" do not require stirrups, except provide a minimum of three stirrups at each end of the lintel where  $S_{a,ICF} > 0.16$ .



| Lintel Span, mm (ft) | Lintel - 12" Thick x 16" Deep (300mm Thick x 400mm Deep), s = 8" (200mm) |                     |                     |                     |                     |                     |                     |                     |                     |                     |                     |                     |                     |                     |                     |                     |                     |                     |
|----------------------|--|---------------------|---------------------|---------------------|---------------------|---------------------|---------------------|---------------------|---------------------|---------------------|---------------------|---------------------|---------------------|---------------------|---------------------|---------------------|---------------------|---------------------|
|                      | Unfactored Point Load  |                     |                     |                     |                     |                     |                     |                     |                     |                     |                     |                     |                     |                     |                     |                     |                     |                     |
|                      | 4 kN<br>800 lb   |                     | 7 kN<br>1500 lb     |                     | 10 kN<br>2200 lb    |                     | 13 kN<br>2900 lb    |                     | 16 kN<br>3500 lb    |                     | 19 kN<br>4200 lb    |                     | 21 kN<br>4700 lb    |                     | 24 kN<br>5300 lb    |                     | 27 kN<br>6000 lb    |                     |
|                      | Bottom Reinf. Steel  | Stirrups Required ? | Bottom Reinf. Steel | Stirrups Required ? | Bottom Reinf. Steel | Stirrups Required ? | Bottom Reinf. Steel | Stirrups Required ? | Bottom Reinf. Steel | Stirrups Required ? | Bottom Reinf. Steel | Stirrups Required ? | Bottom Reinf. Steel | Stirrups Required ? | Bottom Reinf. Steel | Stirrups Required ? | Bottom Reinf. Steel | Stirrups Required ? |
| 900 (3)              | 1-10M  | NO                  | 1-10M               | NO                  | 1-10M               | NO                  | 1-10M               | NO                  | 1-10M               | NO                  | 1-10M               | NO                  | 1-10M               | NO                  | 1-15M               | NO                  | 1-15M               | NO                  |
| 1200 (4)             | 1-10M  | NO                  | 1-10M               | NO                  | 1-10M               | NO                  | 1-10M               | NO                  | 1-15M               | NO                  | 1-15M               | NO                  | 1-15M               | NO                  | 1-15M               | NO                  | 1-15M               | NO                  |
| 1500 (5)             | 1-10M  | NO                  | 1-10M               | NO                  | 1-10M               | NO                  | 1-15M               | NO                  | 1-15M               | NO                  | 1-15M               | NO                  | 1-20M               | NO                  | 1-20M               | NO                  | 1-20M               | YES                 |
| 1800 (6)             | 1-10M  | NO                  | 1-15M               | NO                  | 1-15M               | NO                  | 1-15M               | NO                  | 1-20M               | NO                  | 1-20M               | NO                  | 1-20M               | NO                  | 2-15M               | NO                  | 2-15M               | YES                 |
| 2400 (8)             | 1-15M  | NO                  | 1-20M               | NO                  | 1-20M               | NO                  | 1-20M               | NO                  | 1-20M               | NO                  | 2-15M               | NO                  | 1-15M + 1-20M       | NO                  | 2-20M               | NO                  | 1-15M + 2-20M       | YES                 |
| 3000 (10)            | 1-20M  | NO                  | 1-20M               | NO                  | 2-15M               | NO                  | 2-15M               | NO                  | 1-15M + 1-20M       | NO                  | 2-20M               | NO                  | 1-15M + 2-20M       | NO                  | 1-10M + 3-20M       | YES                 |                     |                     |
| 3600 (12)            | 1-20M  | NO                  | 2-15M               | NO                  | 1-15M + 1-20M       | NO                  | 2-20M               | NO                  | 1-10M + 2-20M       | NO                  | 1-10M + 3-20M       | NO                  | 4-20M               | NO                  |                     |                     |                     |                     |
| 4200 (14)            | 2-15M  | NO                  | 2-20M               | NO                  | 1-10M + 2-20M       | NO                  | 1-15M + 2-20M       | NO                  | 1-10M + 3-20M       | NO                  |                     |                     |                     |                     |                     |                     |                     |                     |
| 4800 (16)            | 2-20M  | NO                  | 1-10M + 2-20M       | NO                  | 1-10M + 3-20M       | NO                  | 4-20M               | NO                  |                     |                     |                     |                     |                     |                     |                     |                     |                     |                     |
| 5400 (18)            | 1-10M + 2-20M  | NO                  | 1-10M + 3-20M       | NO                  | 4-20M               | NO                  |                     |                     |                     |                     |                     |                     |                     |                     |                     |                     |                     |                     |
| 6000 (20)            | 3-20M  | NO                  |                     |                     |                     |                     |                     |                     |                     |                     |                     |                     |                     |                     |                     |                     |                     |                     |

NOTES:

1. Stirrup spacing (s) is given in "inch" and "mm"
2. Do not install more than 4-20M bottom bar or equivalent combination of smaller bars.
3. Bottom reinforcement located 89mm (3.5") from bottom of lintel.
4. This table to be used in conjunction with the "Lintel Design Limitations" & "Lintel Drawing".
5. Beams with "NO Stirrups Required" do not require stirrups, except provide a minimum of three stirrups at each end of the lintel where  $S_{a,ICF} > 0.16$ .

| Lintel Span, mm (ft) | Lintel - 12" Thick x 24" Deep (300mm Thick x 600mm Deep), s = 12" (300mm) |                     |                     |                     |                     |                     |                     |                     |                     |                     |                     |                     |                     |                     |                     |                     |                     |                     |
|----------------------|---|---------------------|---------------------|---------------------|---------------------|---------------------|---------------------|---------------------|---------------------|---------------------|---------------------|---------------------|---------------------|---------------------|---------------------|---------------------|---------------------|---------------------|
|                      | Unfactored Point Load   |                     |                     |                     |                     |                     |                     |                     |                     |                     |                     |                     |                     |                     |                     |                     |                     |                     |
|                      | 4 kN<br>800 lb  |                     | 8 kN<br>1700 lb     |                     | 12 kN<br>2600 lb    |                     | 16 kN<br>3500 lb    |                     | 20 kN<br>4400 lb    |                     | 24 kN<br>5300 lb    |                     | 28 kN<br>6200 lb    |                     | 32 kN<br>7100 lb    |                     | 36 kN<br>8000 lb    |                     |
|                      | Bottom Reinf. Steel   | Stirrups Required ? | Bottom Reinf. Steel | Stirrups Required ? | Bottom Reinf. Steel | Stirrups Required ? | Bottom Reinf. Steel | Stirrups Required ? | Bottom Reinf. Steel | Stirrups Required ? | Bottom Reinf. Steel | Stirrups Required ? | Bottom Reinf. Steel | Stirrups Required ? | Bottom Reinf. Steel | Stirrups Required ? | Bottom Reinf. Steel | Stirrups Required ? |
| 900 (3)              | 1-10M   | NO                  | 1-10M               | NO                  | 1-10M               | NO                  | 1-10M               | NO                  | 1-10M               | NO                  | 1-10M               | NO                  | 1-10M               | NO                  | 1-10M               | NO                  | 1-15M               | NO                  |
| 1200 (4)             | 1-10M   | NO                  | 1-10M               | NO                  | 1-10M               | NO                  | 1-10M               | NO                  | 1-10M               | NO                  | 1-10M               | NO                  | 1-15M               | NO                  | 1-15M               | NO                  | 1-15M               | NO                  |
| 1500 (5)             | 1-10M   | NO                  | 1-10M               | NO                  | 1-10M               | NO                  | 1-10M               | NO                  | 1-15M               | NO                  | 1-15M               | NO                  | 1-15M               | NO                  | 1-15M               | NO                  | 1-15M               | NO                  |
| 1800 (6)             | 1-10M   | NO                  | 1-10M               | NO                  | 1-10M               | NO                  | 1-15M               | NO                  | 1-15M               | NO                  | 1-15M               | NO                  | 1-15M               | NO                  | 1-20M               | NO                  | 1-20M               | NO                  |
| 2400 (8)             | 1-15M   | NO                  | 1-15M               | NO                  | 1-15M               | NO                  | 1-15M               | NO                  | 1-20M               | NO                  | 1-20M               | NO                  | 2-15M               | NO                  | 2-15M               | NO                  | 2-15M               | YES                 |
| 3000 (10)            | 1-15M   | NO                  | 1-20M               | NO                  | 1-20M               | NO                  | 2-15M               | NO                  | 2-15M               | NO                  | 2-15M               | NO                  | 1-15M + 1-20M       | NO                  | 2-20M               | NO                  | 1-10M + 2-20M       | YES                 |
| 3600 (12)            | 1-20M   | NO                  | 2-15M               | NO                  | 2-15M               | NO                  | 2-15M               | NO                  | 2-15M               | NO                  | 2-20M               | NO                  | 1-10M + 2-20M       | NO                  | 1-15M + 2-20M       | NO                  |                     |                     |
| 4200 (14)            | 2-15M   | NO                  | 2-15M               | NO                  | 2-15M               | NO                  | 1-15M + 1-20M       | NO                  | 2-20M               | NO                  | 1-10M + 2-20M       | NO                  | 3-20M               | NO                  |                     |                     |                     |                     |
| 4800 (16)            | 2-15M   | NO                  | 1-15M + 1-20M       | NO                  | 2-20M               | NO                  | 1-10M + 2-20M       | NO                  | 1-15M + 2-20M       | NO                  | 1-10M + 3-20M       | NO                  | 4-20M               | NO                  |                     |                     |                     |                     |
| 5400 (18)            | 1-15M + 1-20M   | NO                  | 2-20M               | NO                  | 1-10M + 2-20M       | NO                  | 3-20M               | NO                  | 1-10M + 3-20M       | NO                  | 4-20M               | NO                  |                     |                     |                     |                     |                     |                     |
| 6000 (20)            | 2-20M   | NO                  | 1-10M + 2-20M       | NO                  | 3-20M               | NO                  | 1-15M + 3-20M       | NO                  |                     |                     |                     |                     |                     |                     |                     |                     |                     |                     |

NOTES:

1. Stirrup spacing (s) is given in "inch" and "mm"
2. Do not install more than 4-20M bottom bar or equivalent combination of smaller bars.
3. Bottom reinforcement located 89mm (3.5") from bottom of lintel.
4. This table to be used in conjunction with the "Lintel Design Limitations" & "Lintel Drawing".
5. Beams with "NO Stirrups Required" do not require stirrups, except provide a minimum of three stirrups at each end of the lintel where  $S_{a,ICF} > 0.16$ .



| Lintel Span, mm (ft) | Lintel - 12" Thick x 32" Deep (300mm Thick x 800mm Deep), s = 16" (400mm) |                     |                     |                     |                     |                     |                     |                     |                     |                     |                     |                     |                     |                     |                     |                     |                     |                     |
|----------------------|---|---------------------|---------------------|---------------------|---------------------|---------------------|---------------------|---------------------|---------------------|---------------------|---------------------|---------------------|---------------------|---------------------|---------------------|---------------------|---------------------|---------------------|
|                      | Unfactored Point Load   |                     |                     |                     |                     |                     |                     |                     |                     |                     |                     |                     |                     |                     |                     |                     |                     |                     |
|                      | 4 kN<br>800 lb  |                     | 9 kN<br>2000 lb     |                     | 14 kN<br>3100 lb    |                     | 19 kN<br>4200 lb    |                     | 24 kN<br>5300 lb    |                     | 29 kN<br>6500 lb    |                     | 34 kN<br>7600 lb    |                     | 39 kN<br>8700 lb    |                     | 44 kN<br>9800 lb    |                     |
|                      | Bottom Reinf. Steel   | Stirrups Required ? | Bottom Reinf. Steel | Stirrups Required ? | Bottom Reinf. Steel | Stirrups Required ? | Bottom Reinf. Steel | Stirrups Required ? | Bottom Reinf. Steel | Stirrups Required ? | Bottom Reinf. Steel | Stirrups Required ? | Bottom Reinf. Steel | Stirrups Required ? | Bottom Reinf. Steel | Stirrups Required ? | Bottom Reinf. Steel | Stirrups Required ? |
| 900 (3)              | 1-10M   | NO                  | 1-10M               | NO                  | 1-10M               | NO                  | 1-10M               | NO                  | 1-10M               | NO                  | 1-10M               | NO                  | 1-10M               | NO                  | 1-10M               | NO                  | 1-10M               | NO                  |
| 1200 (4)             | 1-10M   | NO                  | 1-10M               | NO                  | 1-10M               | NO                  | 1-10M               | NO                  | 1-10M               | NO                  | 1-10M               | NO                  | 1-10M               | NO                  | 1-15M               | NO                  | 1-15M               | NO                  |
| 1500 (5)             | 1-10M   | NO                  | 1-10M               | NO                  | 1-10M               | NO                  | 1-10M               | NO                  | 1-10M               | NO                  | 1-15M               | NO                  | 1-15M               | NO                  | 1-15M               | NO                  | 1-15M               | NO                  |
| 1800 (6)             | 1-10M   | NO                  | 1-10M               | NO                  | 1-10M               | NO                  | 1-10M               | NO                  | 1-15M               | NO                  | 1-15M               | NO                  | 1-15M               | NO                  | 1-15M               | NO                  | 1-20M               | NO                  |
| 2400 (8)             | 1-10M   | NO                  | 1-15M               | NO                  | 1-15M               | NO                  | 1-15M               | NO                  | 1-15M               | NO                  | 1-20M               | NO                  | 2-15M               | NO                  | 2-15M               | NO                  | 1-15M + 1-20M       | NO                  |
| 3000 (10)            | 1-15M   | NO                  | 1-15M               | NO                  | 1-15M               | NO                  | 1-20M               | NO                  | 2-15M               | NO                  | 2-15M               | NO                  | 1-15M + 1-20M       | NO                  | 1-15M + 1-20M       | NO                  | 2-20M               | YES                 |
| 3600 (12)            | 1-15M   | NO                  | 1-20M               | NO                  | 1-20M               | NO                  | 2-15M               | NO                  | 1-15M + 1-20M       | NO                  | 1-15M + 1-20M       | NO                  | 2-20M               | NO                  | 1-15M + 2-20M       | NO                  |                     |                     |
| 4200 (14)            | 1-20M   | NO                  | 2-15M               | NO                  | 2-15M               | NO                  | 1-15M + 1-20M       | NO                  | 1-15M + 1-20M       | NO                  | 1-10M + 2-20M       | NO                  | 1-15M + 2-20M       | NO                  |                     |                     |                     |                     |
| 4800 (16)            | 2-15M   | NO                  | 1-15M + 1-20M       | NO                  | 1-15M + 1-20M       | NO                  | 1-15M + 1-20M       | NO                  | 1-10M + 2-20M       | NO                  | 3-20M               | NO                  |                     |                     |                     |                     |                     |                     |
| 5400 (18)            | 1-15M + 1-20M   | NO                  | 1-15M + 1-20M       | NO                  | 1-15M + 1-20M       | NO                  | 3-20M               | NO                  | 3-20M               | NO                  | 1-15M + 3-20M       | NO                  |                     |                     |                     |                     |                     |                     |
| 6000 (20)            | 1-15M + 1-20M   | NO                  | 2-20M               | NO                  | 1-10M + 2-20M       | NO                  | 1-15M + 2-20M       | NO                  | 1-15M + 3-20M       | NO                  |                     |                     |                     |                     |                     |                     |                     |                     |

NOTES:

1. Stirrup spacing (s) is given in "inch" and "mm"
2. Do not install more than 4-20M bottom bar or equivalent combination of smaller bars.
3. Bottom reinforcement located 89mm (3.5") from bottom of lintel.
4. This table to be used in conjunction with the "Lintel Design Limitations" & "Lintel Drawing".
5. Beams with "NO Stirrups Required" do not require stirrups, except provide a minimum of three stirrups at each end of the lintel where  $S_{a,ICF} > 0.16$ .

# ICFMA

## INSULATING CONCRETE FORMS MANUFACTURERS ASSOCIATION



## Concentrated Point Load Table

**Table C. 1. Maximum Un-Factored Point Load on a Solid Wall Without Opening**

| Solid Wall Length Under a Point Load, m(ft) | 0.91 (3) | 1.22 (4) | 1.52 (5) |
|---|----------|----------|----------|
| Maximum Unfactored Point Load, kN           | 225      | 300      | 375      |

**NOTES:**

1. Provide beam pockets, as necessary.
2. In addition to the wall reinforcing required in the following tables, two additional 15M vertical bars shall be installed directly below the point load.
3. Maximum un-factored point loads given in Table C. 1 are only the wall capacity. It is the responsibility of the roof and floor designer to ensure adequate bearing for all framing members is provided on the concrete walls.

# ICFMA

## INSULATING CONCRETE FORMS MANUFACTURERS ASSOCIATION



## Stair Opening Tables

**Table A. 12. Above Grade Wall Distributed Horizontal Reinforcement at Stair Openings**

Seismic Zone Classification:  $S_{a,ICF} \leq 0.79$

Hourly wind Pressure:  $q_{1/50} \leq 1.05$

| Wall Thickness<br>mm(in) | Max Length of Stair Opening<br>(Unsupported Length of Wall)<br>m(ft) | Block Height<br>mm(in) | Horizontal Reinforcement Size and Spacing, mm (in) |                           |                           |
|--------------------------|--|------------------------|--|---------------------------|---------------------------|
|                          |  |                        | Seismic Zone Classification, $S_{a,ICF}$           |                           |                           |
|                          |  |                        | $\leq 0.16$  | $\leq 0.31$               | $\leq 0.79$               |
|                          |  |                        | Hourly Winds Pressure, $q_{1/50}$ (kPa)            |                           |                           |
|                          |  |                        | $\leq 0.5$   | $\leq 0.75$               | $\leq 1.05$               |
| 150 (6)                  | 4.5 (15)   | 300 (12) & 450 (18)    | 15M @ 450 (18)                                     | 15M @ 450 (18)            | 15M @ 300 (12)            |
|                          |  | 400 (16)               | 15M @ 400 (16)                                     | 15M @ 400 (16)            | 15M @ 300 (12)            |
| 200 (8)                  | 5.1 (17)   | 300 (12) & 450 (18)    | 15M @ 450 (18)                                     | 15M @ 450 (18)            | 15M @ 300 (12)            |
|                          |  | 400 (16)               | 15M @ 400 (16)                                     | 15M @ 400 (16)            | 15M @ 300 (12)            |
| 250 (10)                 | 5.1 (17)   | 300 (12) & 450 (18)    | 10M @ 450 (18)                                     | 15M @ 450 (18)            | 15M @ 300 (12)            |
|                          |  | 400 (16)               | 10M @ 400 (16)                                     | 15M @ 400 (16)            | 15M @ 300 (12)            |
| 300 (12)                 | 5.7 (19)   | 300 (12) & 450 (18)    | 10M @ 450 (18) (2 layers)                          | 10M @ 450 (18) (2 layers) | 15M @ 300 (12) (2 layers) |
|                          |  | 400 (16)               | 10M @ 400 (16) (2 layers)                          | 10M @ 400 (16) (2 layers) | 15M @ 300 (12) (2 layers) |

**NOTES:**

1. This table to be used in conjunction with the "Design Parameters".
2. This table applies to all height of above grade walls where there is no lateral support at the floor level because of stair opening.
3. The laterally unsupported length at the top of the wall is the dimension of the stair opening parallel to the wall.
4. Single bars are to be staggered and the vertical bars are to be placed between these staggered bars, as per Detail A.1 and A.2.
5. Increase the horizontal reinforcement as per this table and extend beyond the stair opening a minimum of 900mm (3'-0"), bend bars, if necessary, at wall corners.
6. Provide a minimum of 1.22m (4'-0") length of laterally supported wall on each side of the opening. The 1.22m (4'-0") length may be a perpendicular wall on the same side as the stair opening. Bend horizontal bars around the corner to provide the minimum required 900mm (3'-0") extension.
7. Increase the vertical reinforcement on each side of the stair opening per the "Design Limitation" noted in section 5.5.5.
8. Place the reinforcing for 6", 8" and 10" thick wall in accordance with Detail A.1.
9. Provide two layers of indicated horizontal reinforcing for 300mm (12") walls. Place each layer as shown in Detail A.2.
10. Alternating horizontal bar spacing of 12" o.c. and 24" o.c. may be used to achieve an average spacing of 18" o.c. where 18" o.c. spacing is specified for horizontal bars.
11. Provide 3 horizontal bars in every two rows of 18" high block to achieve an average spacing of 12" o.c. where 12" spacing o.c. is specified for horizontal bars.
12. Provide 4 horizontal bars in every three rows of 16" high block to achieve an average spacing of 12" o.c. where 12" spacing o.c. is specified for horizontal bars.

INSULATING CONCRETE FORMS  
MANUFACTURERS ASSOCIATION



**Table B. 5. Below Grade Wall Distributed Horizontal Reinforcement at Stair Opening for Seismic Zone Classification  $S_a(0.2) \leq 0.7$ , Hourly Wind Pressure ,  $q_{1/50} \leq 1.05$  kPa, and Backfill**

Seismic Zone Classification:  $S_{a,ICF} \leq 0.31$

Hourly wind Pressure:  $q_{1/50} \leq 1.05$

Backfill Equivalent Fluid Density: 480 kg/m<sup>3</sup> (30pcf)

| Wall Thickness<br>mm(in)   | Block Height<br>mm(in) | Horizontal Reinforcement Size and Spacing, mm (in)              |                  |                  |                  |
|--|------------------------|---|------------------|------------------|------------------|
|  |                        | Seismic Zone Classification, $S_{a,ICF} \leq 0.11$              |                  |                  |                  |
|  |                        | Max Length of Stair Opening (Unsupported Length of Wall), m(ft) |                  |                  |                  |
|  |                        | 2.44 (8)  | 3.05 (10)        | 3.66 (12)        | 4.27 (14)        |
| 150 (6)  | 300 (12) & 450 (18)    | 15M @ 450 (18)  | 2-15M @ 450 (18) |                  |                  |
|  | 400 (16)               | 15M @ 400 (16)  | 2-15M @ 400 (16) |                  |                  |
| 200 (8)  | 300 (12) & 450 (18)    | 15M @ 450 (18)  | 2-15M @ 450 (18) | 2-15M @ 450 (18) | 2-15M @ 300 (12) |
|  | 400 (16)               | 15M @ 400 (16)  | 2-15M @ 400 (16) | 2-15M @ 400 (16) | 2-15M @ 300 (12) |
| 250 (10)   | 300 (12) & 450 (18)    | 15M @ 450 (18)  | 15M @ 450 (18)   | 2-15M @ 450 (18) | 2-15M @ 450 (18) |
|  | 400 (16)               | 15M @ 400 (16)  | 15M @ 400 (16)   | 2-15M @ 400 (16) | 2-15M @ 400 (16) |
| 300 (12)   | 300 (12) & 450 (18)    | 15M @ 450 (18)  | 15M @ 450 (18)   | 15M @ 450 (18)   | 2-15M @ 450 (18) |
|  | 400 (16)               | 15M @ 400 (16)  | 15M @ 400 (16)   | 15M @ 400 (16)   | 2-15M @ 400 (16) |
| <b>Seismic Zone Classification, <math>S_{a,ICF} \leq 0.31</math></b> |                        |   |                  |                  |                  |
| 150 (6)  | 300 (12) & 450 (18)    |   |                  |                  |                  |
|  | 400 (16)               |   |                  |                  |                  |
| 200 (8)  | 300 (12) & 450 (18)    | 2-15M @ 450 (18)  |                  |                  |                  |
|  | 400 (16)               | 2-15M @ 400 (16)  |                  |                  |                  |
| 250 (10)   | 300 (12) & 450 (18)    | 2-15M @ 450 (18)  | 2-15M @ 450 (18) |                  |                  |
|  | 400 (16)               | 2-15M @ 400 (16)  | 2-15M @ 400 (16) |                  |                  |
| 300 (12)   | 300 (12) & 450 (18)    | 15M @ 450 (18)  | 2-15M @ 450 (18) | 2-15M @ 300 (12) |                  |
|  | 400 (16)               | 15M @ 400 (16)  | 2-15M @ 400 (16) | 2-15M @ 300 (12) |                  |

**NOTES:**

- This table to be used in conjunction with the "Design Parameters".
- This table applies to all height of below grade walls where there is no lateral support at the floor level because of stair opening.
- The laterally unsupported length at the top of the wall is the dimension of the stair opening parallel to the wall.
- The below grade wall maybe backfilled up to 6" below the top of the wall.
- Single bars are to be staggered between first two slots of ICF web on inside face of wall. The vertical bars are to be placed between these staggered bars, as per Detail B.1.
- Where two bars are specified, they are to be placed as a single bundled bar staggered between the first two slots of the ICF web on the inside face of the wall. The vertical bars are to be placed between these staggered bars, as per Detail B.1.
- Increase the horizontal reinforcement as per this table and extend beyond the stair opening a minimum of 900mm (3'-0"), bend bars, if necessary, at wall corners.
- Provide a minimum of 1.22m (4'-0") length of laterally supported wall on each side of the opening. The 1.22m (4'-0") length may be a perpendicular wall on the same side as the stair opening. Bend horizontal bars around the corner to provide the minimum required 900mm (3'-0") extension.
- Increase the vertical reinforcement on each side of the stair opening per the "Design Limitation" noted in section 5.5.5.
- Reinforce the foundation wall at the stair opening as per the below grade wall reinforcement tables and this table for a minimum of 1.22m (4'-0") beyond each end of the stair opening for foundation wall that would not otherwise require reinforcing.
- Basement walls with stair opening at locations with Seismic Zone Classification  $S_{a,ICF} > 0.31$  or Backfill Equivalent Fluid Density  $> 480$  kg/m<sup>3</sup> (30pcf) shall be designed by a professional engineer.
- Alternating horizontal bar spacing of 12" o.c. and 24" o.c. may be used to achieve an average spacing of 18" o.c. where 18" o.c. spacing is specified for horizontal bars.
- Provide 3 horizontal bars in every two rows of 18" high block to achieve an average spacing of 12" o.c. where 12" spacing o.c. is specified for horizontal bars.
- Provide 4 horizontal bars in every three rows of 16" high block to achieve an average spacing of 12" o.c. where 12" spacing o.c. is specified for horizontal bars.



**Table A. 13. Bar Spacing Required at Each Side of the Stair Opening**

| S <sub>Table</sub> , mm<br>(in) | Laterally Unsupported Length of the Wall (Stair Opening Length), m (ft) |          |          |          |          |          |          |
|---------------------------------|---|----------|----------|----------|----------|----------|----------|
|                                 | 5.7 (19)  | 5.1 (17) | 4.5 (15) | 3.9 (13) | 2.7 (9)  | 2.1 (7)  | 1.5 (5)  |
|                                 | S <sub>REDUCED</sub>  |          |          |          |          |          |          |
| 1200 (48)                       | 350 (14)  | 375 (15) | 400 (16) | 450 (18) | 550 (22) | 625 (25) | 725 (29) |
| 1050 (42)                       | 300 (12)  | 325 (13) | 350 (14) | 400 (16) | 475 (19) | 550 (22) | 625 (25) |
| 1000 (40)                       | 275 (11)  | 300 (12) | 325 (13) | 375 (15) | 450 (18) | 525 (21) | 600 (24) |
| 900 (36)                        | 250 (10)  | 275 (11) | 300 (12) | 325 (13) | 400 (16) | 475 (19) | 550 (22) |
| 800 (32)                        | 225 (9)   | 250 (10) | 275 (11) | 300 (12) | 375 (15) | 425 (17) | 475 (19) |
| 750 (30)                        | 200 (8)   | 225 (9)  | 250 (10) | 275 (11) | 350 (14) | 400 (16) | 450 (18) |
| 600 (24)                        | 175 (7)   | 175 (7)  | 200 (8)  | 225 (9)  | 275 (11) | 300 (12) | 350 (14) |
| 450 (18)                        |   |          | 150 (6)  | 150 (6)  | 200 (8)  | 225 (9)  | 275 (11) |
| 400 (16)                        |   |          |          | 150 (6)  | 175 (7)  | 200 (8)  | 225 (9)  |
| 300 (12)                        |   |          |          |          |          | 150 (6)  | 175 (7)  |

**Notes:**

1. S<sub>REDUCED</sub> = the bar spacing (mm/in) required at the sides of the stair opening.
2. S<sub>TABLES</sub> = the required bar spacing (mm/in) for a laterally supported wall as determined from above grade and below grade walls tables.
3. If the spacing of the additional vertical reinforcing required on each side of openings, described in the equation given in part 5.5., is less than 150mm (6"), a local design professional shall be retained to prepare the design in accordance with applicable standards.

ICFMA

INSULATING CONCRETE FORMS  
MANUFACTURERS ASSOCIATION





# Laterally Unsupported Foundation Wall Detail and Table

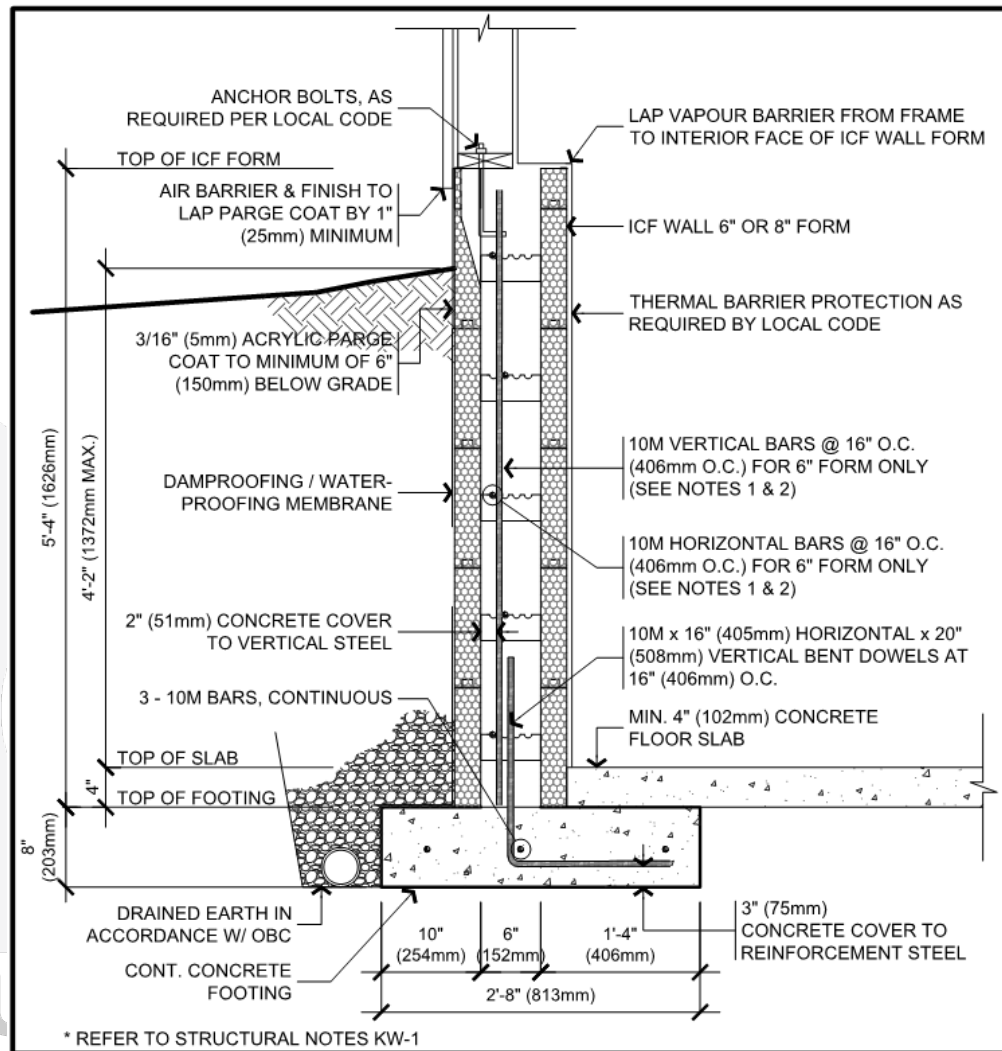

## Notes:

1. This detail applies to one- and two-story buildings conforming to part 9 of the 2020 National Building Code of Canada.
2. Wall reinforcing not required when using 8" forms or thicker (As per table 9.15.4.2.-A of the 2020 National Building Code of Canada).
3. Wall reinforcing not required for 6" forms where the backfill height above basement floor does not exceed 2'-7" (As per table 9.15.4.2.-A of the 2020 National Building Code of Canada).
4. Footing reinforcement and dowels are required for all cases.
5. Refer to section 5.7., for additional information.

## Detail B. 3. Laterally Unsupported Foundation Wall (Knee Wall)



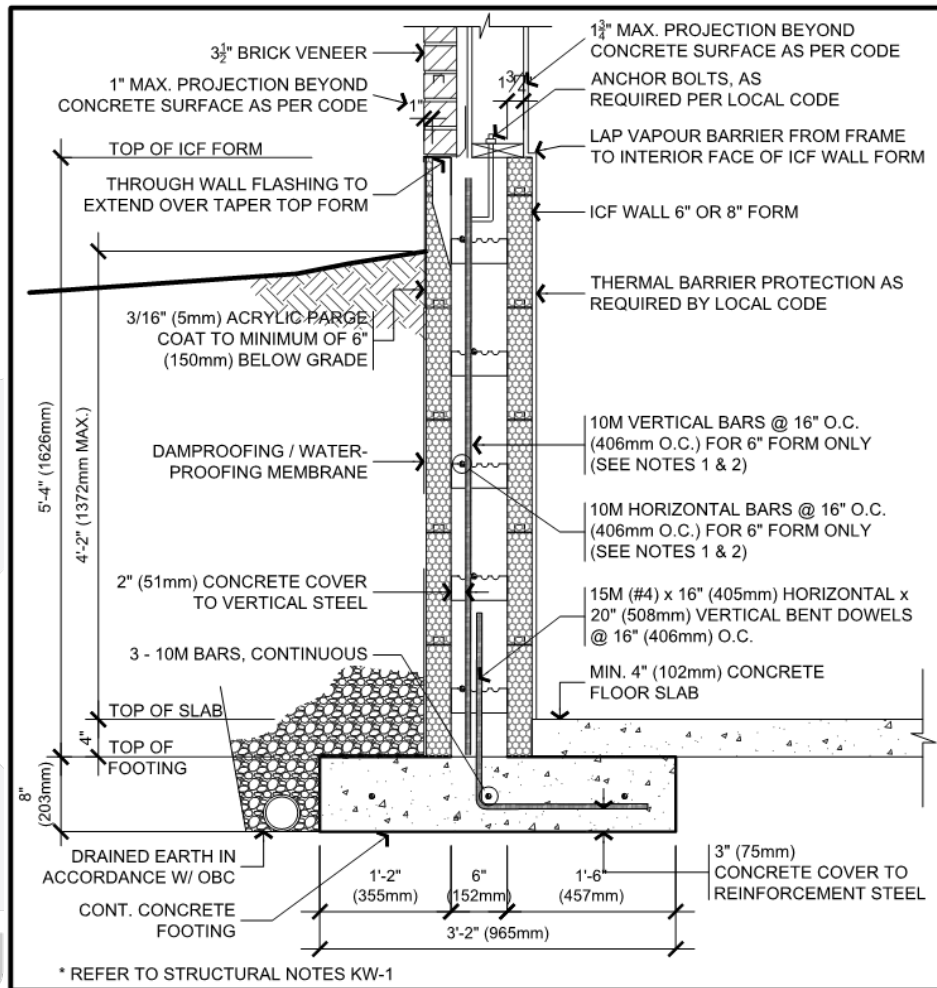

Notes:

1. This detail applies to one- and two-story buildings conforming to part 9 of the 2020 National Building Code of Canada.
2. Wall reinforcing not required when using 8" forms (As per table 9.15.4.2.-A of the 2020 National Building Code of Canada).
3. Wall reinforcing not required for 6" forms where the backfill height above basement floor does not exceed 2'-7" (As per table 9.15.4.2.-A of the 2020 National Building Code of Canada).
4. Footing reinforcement and dowels are required for all cases.
5. Refer to section 5.7., for additional information.

**Detail B. 4. Laterally Unsupported Foundation Wall (Knee Wall) with Brick Veneer**



# Ledger Connection Detail and Table

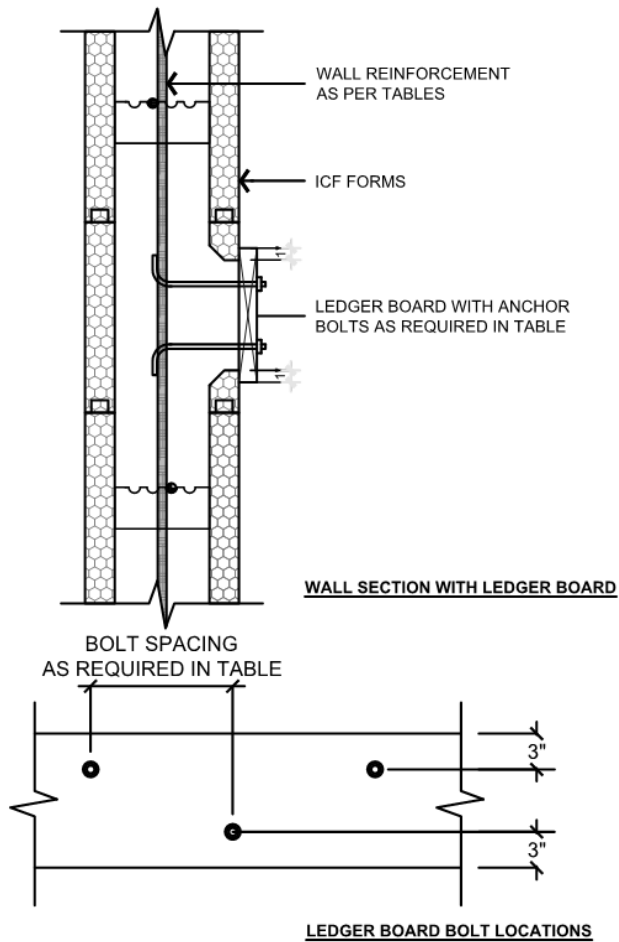

**Detail C. 1. Wood Ledger Connection**

**Table C. 2. Floor Ledger Anchor Bolts Size and Spacing**

| Anchor Bolt Diameter | Minimum Spacing of Staggered Anchors, in |                    |             |             |            |             |
|----------------------|--|--------------------|-------------|-------------|------------|-------------|
|                      | Tie Spacing                              | Floor span, ft (m) |             |             |            |             |
|                      |  | 8' (2.44m)         | 12' (3.66m) | 16' (4.88m) | 20' (6.1m) | 24' (7.32m) |
| 1/2"                 | 6"                                       | 18"                | 12"         | 12"         | 6"         | 6"          |
|                      | 8"                                       | 16"                | 16"         | 8"          | 8"         | 8"          |
| 5/8"                 | 6"                                       | 24"                | 18"         | 12"         | 12"        | 6"          |
|                      | 8"                                       | 24"                | 16"         | 16"         | 8"         | 8"          |

Notes:

1. Anchor bolts to be installed at the indicated spacing and staggered as shown.
2. Design assumes floor ledger supports vertical floor load only. Design of floor diaphragm by others.
3. Design loads: 40psf (1.9 kPa) floor live load, 15psf (0.7 kPa) floor dead load.
4. Anchor bolts shall conform to the requirements of ASTM standard A307.
5. Anchor bolt connection to be installed at Dry Service Condition.



# Brick Ledge Detail and Table

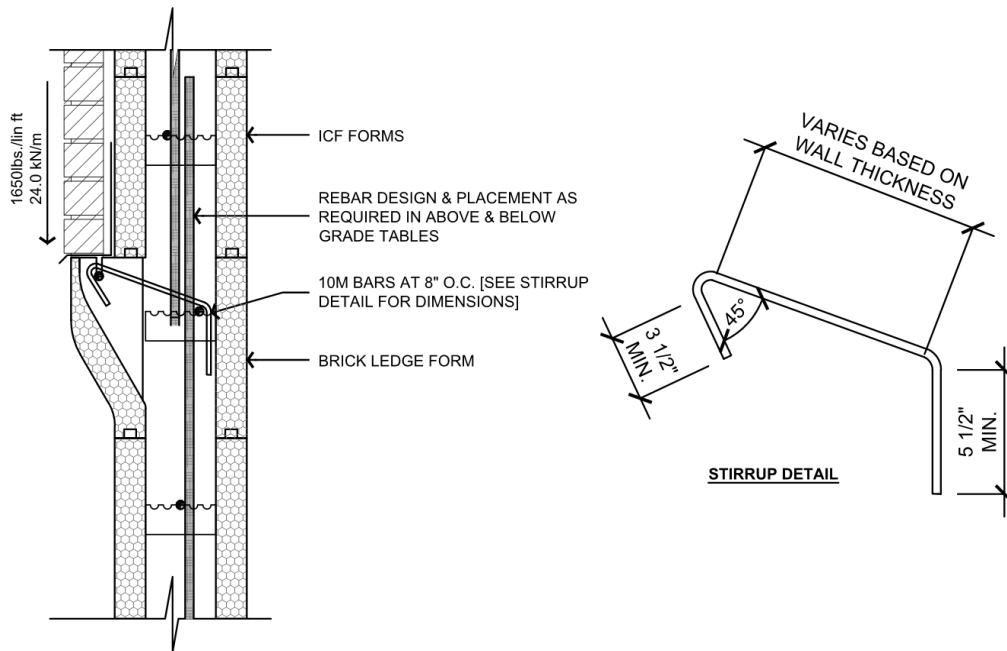

**Detail C. 2. Brick Ledge Connection**

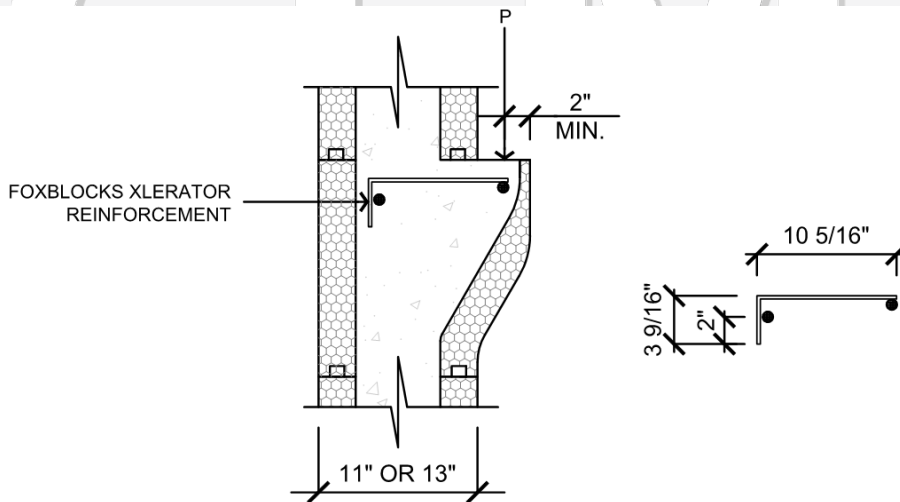

NOTE: XLERATOR REINFORCEMENT TO BE D4 DEFORMED WELDED WIRE WITH A YIELD STRENGTH OF 483MPa (70ksi) IN ACCORDANCE WITH ASTM A1064 REQUIREMENTS.

**Detail C. 3. FOXBLOCKS xLerator Ledge Reinforcement**



**Table C. 3. Brick Ledge Load Capacity**

| Application   | Capacity                         |
|---|----------------------------------|
| Brick<br>- max 4" thick<br>- max 20kN/m <sup>3</sup>                          | 9.6m (31'-6") high               |
| Wood Floor Joists<br>- 0.7kPa (15psf) Dead Load<br>- 1.9kPa (40psf) Live Load | 6.4m (21') Tributary floor width |
| Other<br>- maximum factored load  | 24kN/m (1650 plf)                |

Notes:

1. Concrete Ledge reinforcement is to support floor framing and masonry veneer in conformance with the "Design Limitations".
2. The concrete ledge is to support uniformly distributed loads only. It is not to support concentrated load.
3. The above grade and below grade wall reinforcing tables include the effects of using the ledge to support floor framing.
4. The below grade wall reinforcing tables include the effects of using the ledge to support masonry veneer.
5. The maximum brick height given does not account for windows. To include the effect of windows, it is necessary to calculate an effective brick height.
6. The ledge reinforcement is 10M hooked rebar as shown in Detail C. 2. It is to be placed 6" or 8" on center matching the tie spacing of ICF blocks.
7. Provide the required concrete cover for the vertical leg of the ledge reinforcement.

ICFMA

INSULATING CONCRETE FORMS  
MANUFACTURERS ASSOCIATION



# Footing Details and Tables

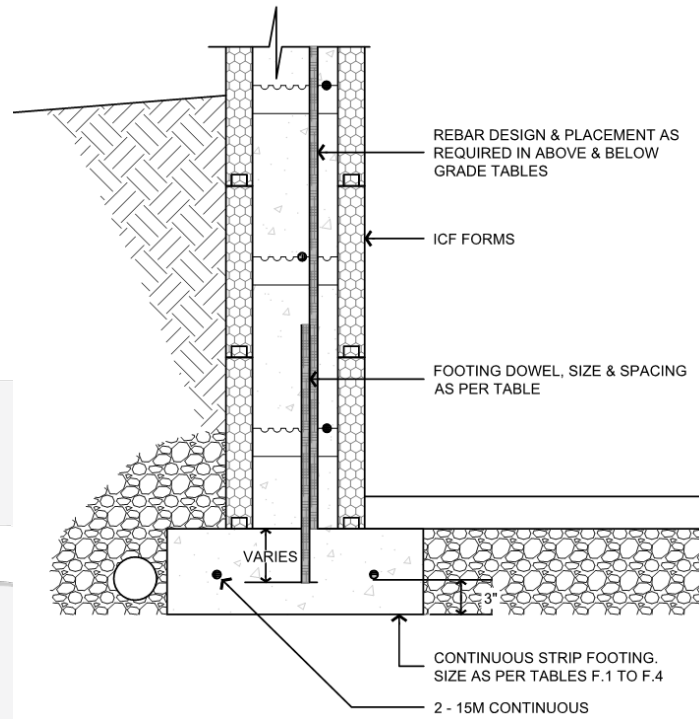

**Detail F. 1. Footing Dowel**

**Table F. 1. Footing Dowels Size and Spacing**

| Rebar Diameter                                     | Maximum Spacing of Vertical Footing Dowels, in |            |            |             |            |
|--|--|------------|------------|-------------|------------|
|  | Backfill Height, ft (m)                        |            |            |             |            |
|  | 4' (1.22m)                                     | 6' (1.83m) | 8' (2.44m) | 10' (3.05m) | 12' (3.66) |
| Seismic Zone Classification: $S_{a,ICF} \leq 0.16$ |  |            |            |             |            |
| 10M  | 48"  | 48"        | 24"        | 8"          | 8"         |
| 15M  | 48"  | 48"        | 36"        | 16"         | 8"         |
| Seismic Zone Classification: $S_{a,ICF} \leq 0.31$ |  |            |            |             |            |
| 10M  | 24"  | 24"        | 16"        | 8"          | 8"         |
| 15M  | 24"  | 24"        | 24"        | 16"         | 8"         |
| Seismic Zone Classification: $S_{a,ICF} \leq 0.79$ |  |            |            |             |            |
| 10M  | 24"  | 16"        |            |             |            |
| 15M  | 24"  | 16"        | 8"         |             |            |

**Notes:**

1. Footing Dowels to be installed as per Details F.1.
2. Provide 18" long straight dowels for  $S_{a,ICF} \leq 0.16$  embedded 6" into the footing.
3. Provide 30"V x 8"H bent dowels for  $S_{a,ICF} > 0.16$  embedded 8" into the footing.
4. Provide 30"V x 8"H bent dowels embedded 8" into the footing at shear walls locations, matching spacing of vertical bars of the shear walls.



**Table F. 2. Minimum Exterior Strip Footing Sizes Not Supporting Roof Loads**

| ICF Wall<br>Thickness,<br>in (mm)  | Minimum Footing Width x Thickness, in x in |            |           |           |
|--|--|------------|-----------|-----------|
|  | Allowable Soil Bearing Pressure, psf (kPa) |            |           |           |
|  | 3000 (144)                                 | 2500 (120) | 2000 (96) | 1500 (72) |
| <b>Two Storey - ICF Basement Walls, Wood Main Floor Walls, and Wood Second Floor Walls</b> |  |            |           |           |
| 6 (150)  | 16" x 6"                                   | 16" x 6"   | 16" x 6"  | 20" x 6"  |
| 8 (200)  | 18" x 6"                                   | 18" x 6"   | 18" x 6"  | 22" x 6"  |
| 10 (250)   | 20" x 6"                                   | 20" x 6"   | 20" x 6"  | 24" x 6"  |
| 12 (300)   | 22" x 6"                                   | 22" x 6"   | 22" x 6"  | 26" x 8"  |
| <b>Two Storey - ICF Basement Walls, ICF Main Floor Walls, and Wood Second Floor Walls</b>  |  |            |           |           |
| 6 (150)  | 16" x 6"                                   | 18" x 6"   | 22" x 8"  | 28" x 8"  |
| 8 (200)  | 18" x 6"                                   | 20" x 6"   | 26" x 8"  | 34" x 10" |
| 10 (250)   | 20" x 6"                                   | 24" x 8"   | 30" x 10" | 40" x 10" |
| 12 (300)   | 22" x 8"                                   | 26" x 8"   | 32" x 10" | 42" x 12" |
| <b>Two Storey - ICF Basement Walls, ICF Main Floor Walls, and ICF Second Floor Walls</b>   |  |            |           |           |
| 6 (150)  | 18" x 8"                                   | 20" x 8"   | 26" x 10" | 34" x 10" |
| 8 (200)  | 22" x 8"                                   | 26" x 8"   | 32" x 10" | 42" x 12" |
| 10 (250)   | 26" x 8"                                   | 30" x 10"  | 38" x 12" | 50" x 14" |
| 12 (300)   | 26" x 8"                                   | 32" x 10"  | 40" x 12" | 52" x 14" |
| <b>One Storey - ICF Basement Walls, and Wood Main Floor Walls</b>                          |  |            |           |           |
| 6 (150)  | 16" x 6"                                   | 16" x 6"   | 16" x 6"  | 16" x 6"  |
| 8 (200)  | 18" x 6"                                   | 18" x 6"   | 18" x 6"  | 18" x 6"  |
| 10 (250)   | 20" x 6"                                   | 20" x 6"   | 20" x 6"  | 20" x 6"  |
| 12 (300)   | 22" x 6"                                   | 22" x 6"   | 22" x 6"  | 22" x 6"  |
| <b>One Storey - ICF Basement Walls, and ICF Main Floor Walls</b>                           |  |            |           |           |
| 6 (150)  | 16" x 6"                                   | 16" x 6"   | 18" x 6"  | 24" x 8"  |
| 8 (200)  | 18" x 6"                                   | 18" x 6"   | 22" x 8"  | 28" x 8"  |
| 10 (250)   | 20" x 6"                                   | 20" x 6"   | 26" x 8"  | 34" x 10" |
| 12 (300)   | 22" x 8"                                   | 22" x 8"   | 28" x 8"  | 36" x 10" |

Notes:

- All footings are to be reinforced with 2-15M continuous bars, as per drawing F.1.
- Refer to the Canadian Design Limitations for maximum floor and roof spans and loads.
- This table does not include masonry veneer. Increase the footing width by 2" and the thickness by 1" for:
  - Every 12'-0" of masonry veneer for 3000 psf soil bearing capacity.
  - Every 10'-0" of masonry veneer for 2500psf soil bearing capacity.
  - Every 8'-0" of masonry veneer for 2000psf soil bearing capacity.
  - Every 6'-0" of masonry veneer for 1500psf soil bearing capacity.
- The footing size for locations with  $S_{a,ICF} > 0.16$  to be the larger of 30" wide by 12" deep or the size shown in the table.



**Table F. 3. Minimum Exterior Strip Footing Sizes Supporting Roof Snow Loads  $\leq 2\text{kPa}$**

| ICF Wall Thickness, in (mm)  | Minimum Footing Width x Thickness, in x in |            |           |           |
|--|--|------------|-----------|-----------|
|  | Allowable Soil Bearing Pressure, psf (kPa) |            |           |           |
|  | 3000 (144)                                 | 2500 (120) | 2000 (96) | 1500 (72) |
| <b>Two Storey - ICF Basement Walls, Wood Main Floor Walls, and Wood Second Floor Walls</b> |  |            |           |           |
| 6 (150)  | 16" x 6"                                   | 18" x 6"   | 22" x 8"  | 28" x 8"  |
| 8 (200)  | 18" x 6"                                   | 20" x 6"   | 24" x 8"  | 32" x 10" |
| 10 (250)   | 20" x 6"                                   | 20" x 6"   | 26" x 8"  | 34" x 10" |
| 12 (300)   | 22" x 8"                                   | 22" x 8"   | 28" x 8"  | 36" x 10" |
| <b>Two Storey - ICF Basement Walls, ICF Main Floor Walls, and Wood Second Floor Walls</b>  |  |            |           |           |
| 6 (150)  | 20" x 8"                                   | 24" x 8"   | 28" x 10" | 38" x 12" |
| 8 (200)  | 22" x 8"                                   | 26" x 10"  | 32" x 10" | 44" x 12" |
| 10 (250)   | 24" x 8"                                   | 30" x 10"  | 36" x 10" | 48" x 14" |
| 12 (300)   | 26" x 8"                                   | 32" x 10"  | 38" x 12" | 52" x 14" |
| <b>Two Storey - ICF Basement Walls, ICF Main Floor Walls, and ICF Second Floor Walls</b>   |  |            |           |           |
| 6 (150)  | 22" x 8"                                   | 26" x 10"  | 32" x 10" | 44" x 12" |
| 8 (200)  | 26" x 10"                                  | 30" x 10"  | 38" x 12" | 50" x 14" |
| 10 (250)   | 30" x 10"                                  | 36" x 12"  | 44" x 14" | 58" x 16" |
| 12 (300)   | 30" x 10"                                  | 36" x 12"  | 46" x 14" | 60" x 16" |
| <b>One Storey - ICF Basement Walls, and Wood Main Floor Walls</b>                          |  |            |           |           |
| 6 (150)  | 16" x 6"                                   | 16" x 6"   | 18" x 6"  | 24" x 8"  |
| 8 (200)  | 18" x 6"                                   | 18" x 6"   | 20" x 6"  | 26" x 8"  |
| 10 (250)   | 20" x 6"                                   | 20" x 6"   | 22" x 6"  | 28" x 8"  |
| 12 (300)   | 22" x 6"                                   | 22" x 6"   | 22" x 6"  | 30" x 8"  |
| <b>One Storey - ICF Basement Walls, and ICF Main Floor Walls</b>                           |  |            |           |           |
| 6 (150)  | 16" x 6"                                   | 20" x 8"   | 24" x 8"  | 32" x 10" |
| 8 (200)  | 20" x 8"                                   | 24" x 8"   | 28" x 10" | 38" x 10" |
| 10 (250)   | 22" x 8"                                   | 26" x 8"   | 32" x 10" | 44" x 12" |
| 12 (300)   | 24" x 8"                                   | 28" x 10"  | 34" x 10" | 46" x 12" |

Notes:

1. All footings are to be reinforced with 2-15M continuous bars, as per drawing F.1.
2. Refer to the Canadian Design Limitations for maximum floor and roof spans and loads.
3. This table does not include masonry veneer. Increase the footing width by 2" and the thickness by 1" for:
  - a) Every 12'-0" of masonry veneer for 3000 psf soil bearing capacity.
  - b) Every 10'-0" of masonry veneer for 2500psf soil bearing capacity.
  - c) Every 8'-0" of masonry veneer for 2000psf soil bearing capacity.
  - d) Every 6'-0" of masonry veneer for 1500psf soil bearing capacity.
4. The footing size for locations with  $S_{a,ICF} > 0.16$  to be the larger of 30" wide by 12" deep or the size shown in the table.



**Table F. 4. Minimum Exterior Strip Footing Sizes Supporting Roof Snow Loads  $\leq 4\text{kPa}$**

| ICF Wall Thickness, in (mm)  | Minimum Footing Width x Thickness, in x in |            |           |           |
|--|--|------------|-----------|-----------|
|  | Allowable Soil Bearing Pressure, psf (kPa) |            |           |           |
|  | 3000 (144)                                 | 2500 (120) | 2000 (96) | 1500 (72) |
| <b>Two Storey - ICF Basement Walls, Wood Main Floor Walls, and Wood Second Floor Walls</b> |  |            |           |           |
| 6 (150)  | 18" x 8"                                   | 22" x 8"   | 26" x 10" | 36" x 10" |
| 8 (200)  | 20" x 8"                                   | 24" x 8"   | 28" x 10" | 38" x 10" |
| 10 (250)   | 20" x 6"                                   | 24" x 8"   | 30" x 10" | 40" x 10" |
| 12 (300)   | 22" x 8"                                   | 26" x 8"   | 32" x 10" | 42" x 12" |
| <b>Two Storey - ICF Basement Walls, ICF Main Floor Walls, and Wood Second Floor Walls</b>  |  |            |           |           |
| 6 (150)  | 22" x 8"                                   | 28" x 10"  | 34" x 12" | 44" x 14" |
| 8 (200)  | 26" x 10"                                  | 30" x 10"  | 38" x 12" | 50" x 14" |
| 10 (250)   | 28" x 10"                                  | 34" x 12"  | 42" x 12" | 56" x 16" |
| 12 (300)   | 30" x 10"                                  | 36" x 12"  | 44" x 14" | 58" x 16" |
| <b>Two Storey - ICF Basement Walls, ICF Main Floor Walls, and ICF Second Floor Walls</b>   |  |            |           |           |
| 6 (150)  | 26" x 10"                                  | 30" x 12"  | 38" x 12" | 50" x 14" |
| 8 (200)  | 30" x 12"                                  | 34" x 12"  | 44" x 14" | 58" x 16" |
| 10 (250)   | 34" x 12"                                  | 40" x 14"  | 50" x 16" | 66" x 18" |
| 12 (300)   | 34" x 12"                                  | 40" x 14"  | 50" x 16" | 68" x 18" |
| <b>One Storey - ICF Basement Walls, and Wood Main Floor Walls</b>                          |  |            |           |           |
| 6 (150)  | 16" x 6"                                   | 18" x 6"   | 22" x 8"  | 30" x 10" |
| 8 (200)  | 18" x 6"                                   | 20" x 6"   | 24" x 8"  | 32" x 10" |
| 10 (250)   | 20" x 6"                                   | 22" x 6"   | 26" x 8"  | 34" x 10" |
| 12 (300)   | 22" x 8"                                   | 22" x 8"   | 28" x 8"  | 38" x 10" |
| <b>One Storey - ICF Basement Walls, and ICF Main Floor Walls</b>                           |  |            |           |           |
| 6 (150)  | 20" x 8"                                   | 24" x 8"   | 30" x 10" | 38" x 12" |
| 8 (200)  | 22" x 8"                                   | 28" x 10"  | 34" x 10" | 44" x 12" |
| 10 (250)   | 26" x 8"                                   | 30" x 10"  | 38" x 12" | 50" x 14" |
| 12 (300)   | 26" x 8"                                   | 32" x 10"  | 40" x 12" | 52" x 14" |

Notes:

- All footings are to be reinforced with 2-15M continuous bars, as per drawing F.1.
- Refer to the Canadian Design Limitations for maximum floor and roof spans and loads.
- This table does not include masonry veneer. Increase the footing width by 2" and the thickness by 1" for:
  - Every 12'-0" of masonry veneer for 3000 psf soil bearing capacity.
  - Every 10'-0" of masonry veneer for 2500psf soil bearing capacity.
  - Every 8'-0" of masonry veneer for 2000psf soil bearing capacity.
  - Every 6'-0" of masonry veneer for 1500psf soil bearing capacity.
- The footing size for locations with  $S_{a,ICF} > 0.16$  to be the larger of 30" wide by 12" deep or the size shown in the table.



# Appendix A. Equivalent Spectral Response Acceleration for ICF Walls, $S_{a,ICF}^*$

| Province and Location   | $S_{a,ICF}$ |
|-------------------------|-------------|
| <b>British Columbia</b> |             |
| 100 Mile House          | 0.123       |
| Abbotsford              | 0.518       |
| Agassiz                 | 0.374       |
| Alberni                 | ---         |
| Ashcroft                | 0.172       |
| Bamfield                | ---         |
| Beaton River            | 0.108       |
| Bella Bella             | 0.257       |
| Bella Coola             | 0.182       |
| Burns Lake              | 0.092       |
| Cache Creek             | 0.168       |
| Campbell River          | 0.549       |
| Carmi                   | 0.129       |
| Castlegar               | 0.108       |
| Chetwynd                | 0.147       |
| Chilliwack              | 0.421       |
| Comox                   | 0.621       |
| Courtenay               | 0.626       |
| Cranbrook               | 0.138       |
| Crescent Valley         | 0.108       |
| Crofton                 | ---         |
| Dawson Creek            | 0.119       |
| Dease Lake              | 0.148       |
| Dog Creek               | 0.147       |
| Duncan                  | ---         |
| Elko                    | 0.169       |
| Fernie                  | 0.177       |
| Fort Nelson             | 0.123       |
| Fort St. John           | 0.117       |
| Glacier                 | 0.155       |
| Gold River              | ---         |
| Golden                  | 0.189       |
| Grand Forks             | 0.117       |
| Greenwood               | 0.122       |
| Hope                    | 0.308       |
| Jordan River            | ---         |
| Kamloops                | 0.132       |
| Kaslo                   | 0.116       |
| Kelowna                 | 0.131       |
| Kimberley               | 0.134       |
| Kitimat Plant           | 0.197       |
| Kitimat Townsite        | 0.197       |
| Ladysmith               | ---         |
| Langford                | ---         |
| Lillooet                | 0.227       |
| Lytton                  | 0.241       |
| Mackenzie               | 0.137       |
| Masset                  | 0.738       |
| McBride                 | 0.176       |
| McLeod Lake             | 0.129       |
| Merritt                 | 0.187       |
| Mission City            | 0.487       |
| Montrose                | 0.108       |
| Nakusp                  | 0.111       |
| Nanaimo                 | 0.769       |
| Nelson                  | 0.123       |
| Ocean Falls             | 0.219       |
| Osoyoos                 | 0.159       |

| Province and Location          | $S_{a,ICF}$ |
|--------------------------------|-------------|
| Parksville                     | 0.723       |
| Penticton                      | 0.146       |
| Port Alberni                   | ---         |
| Port Alice                     | ---         |
| Port Hardy                     | 0.605       |
| Port McNeill                   | 0.621       |
| Port Renfrew                   | ---         |
| Powell River                   | 0.523       |
| Prince George                  | 0.100       |
| Prince Rupert                  | 0.301       |
| Princeton                      | 0.221       |
| Qualicum Beach                 | 0.713       |
| Queen Charlotte City           | ---         |
| Quesnel                        | 0.096       |
| Revelstoke                     | 0.118       |
| Salmon Arm                     | 0.114       |
| Sandspit                       | ---         |
| Sechelt                        | 0.615       |
| Sidney                         | ---         |
| Smith River                    | 0.414       |
| Smithers                       | 0.101       |
| Sooke                          | ---         |
| Squamish                       | 0.463       |
| Stewart                        | 0.185       |
| Tahsis                         | ---         |
| Taylor                         | 0.116       |
| Terrace                        | 0.175       |
| Tofino                         | ---         |
| Trail                          | 0.108       |
| Ucluelet                       | ---         |
| <b>Vancouver Region</b>        |             |
| Burnaby (Simon Fraser Univ.)   | 0.554       |
| Cloverdale                     | 0.579       |
| Haney                          | 0.513       |
| Ladner                         | 0.662       |
| Langley                        | 0.559       |
| New Westminster                | 0.574       |
| North Vancouver                | 0.569       |
| Richmond                       | 0.631       |
| Surrey (88 Ave & 156 St.)      | 0.569       |
| Vancouver (City Hall)          | 0.605       |
| Vancouver (Granville & 41 Ave) | 0.615       |
| West Vancouver                 | 0.585       |
| Vernon                         | 0.118       |
| <b>Victoria Region</b>         |             |
| Victoria (Gonzales Hts)        | ---         |
| Victoria (Mt Tolmie)           | ---         |
| Victoria                       | ---         |
| Whistler                       | 0.351       |
| White Rock                     | 0.621       |
| Williams Lake                  | 0.118       |
| Youbou                         | ---         |
| <b>Alberta</b>                 |             |
| Athabasca                      | 0.067       |
| Banff                          | 0.202       |
| Barrhead                       | 0.087       |
| Beaverlodge                    | 0.120       |
| Brooks                         | 0.091       |

| Province and Location | $S_{a,ICF}$ |
|-----------------------|-------------|
| Calgary               | 0.137       |
| Campsie               | 0.090       |
| Camrose               | 0.079       |
| Canmore               | 0.201       |
| Cardston              | 0.198       |
| Claresholm            | 0.160       |
| Cold Lake             | 0.053       |
| Coleman               | 0.203       |
| Coronation            | 0.070       |
| Cowley                | 0.205       |
| Drumheller            | 0.093       |
| Edmonton              | 0.083       |
| Edson                 | 0.124       |
| Embaras Portage       | 0.050       |
| Fairview              | 0.097       |
| Fort MacLeod          | 0.167       |
| Fort McMurray         | 0.052       |
| Fort Saskatchewan     | 0.075       |
| Fort Vermilion        | 0.059       |
| Grande Prairie        | 0.111       |
| Habay                 | 0.072       |
| Hardisty              | 0.065       |
| High River            | 0.150       |
| Hinton                | 0.198       |
| Jasper                | 0.204       |
| Keg River             | 0.070       |
| Lac la Biche          | 0.059       |
| Lacombe               | 0.097       |
| Lethbridge            | 0.126       |
| Manning               | 0.077       |
| Medicine Hat          | 0.077       |
| Peace River           | 0.086       |
| Pincher Creek         | 0.207       |
| Ranfurly              | 0.064       |
| Red Deer              | 0.101       |
| Rocky Mountain House  | 0.130       |
| Slave Lake            | 0.072       |
| Stettler              | 0.086       |
| Stony Plain           | 0.090       |
| Suffield              | 0.084       |
| Taber                 | 0.106       |
| Turner Valley         | 0.180       |
| Valleyview            | 0.100       |
| Vegreville            | 0.066       |
| Vermilion             | 0.059       |
| Wagner                | 0.073       |
| Wainwright            | 0.062       |
| Wetaskiwin            | 0.089       |
| Whitecourt            | 0.098       |
| Wimborne              | 0.101       |
| <b>Saskatchewan</b>   |             |
| Assiniboia            | 0.112       |
| Batrum                | 0.069       |
| Biggar                | 0.060       |
| Broadview             | 0.077       |
| Dafoe                 | 0.064       |
| Dundurn               | 0.063       |
| Estevan               | 0.105       |
| Hudson Bay            | 0.053       |

| Province and Location | $S_{a,ICF}$ |
|-----------------------|-------------|
| Humboldt              | 0.060       |
| Island Falls          | 0.047       |
| Kamsack               | 0.059       |
| Kindersley            | 0.063       |
| Lloydminster          | 0.057       |
| Maple Creek           | 0.071       |
| Meadow Lake           | 0.052       |
| Melfort               | 0.055       |
| Melville              | 0.070       |
| Moose Jaw             | 0.091       |
| Nipawin               | 0.052       |
| North Battleford      | 0.057       |
| Prince Albert         | 0.054       |
| Qu'Appelle            | 0.086       |
| Regina                | 0.092       |
| Rosetown              | 0.063       |
| Saskatoon             | 0.061       |
| Scott                 | 0.059       |
| Strasbourg            | 0.075       |
| Swift Current         | 0.074       |
| Uranium City          | 0.046       |
| Weyburn               | 0.126       |
| Yorkton               | 0.065       |
| <b>Manitoba</b>       |             |
| Beausejour            | 0.048       |
| Boissevain            | 0.058       |
| Brandon               | 0.058       |
| Churchill             | 0.047       |
| Dauphin               | 0.055       |
| Flin Flon             | 0.047       |
| Gimli                 | 0.048       |
| Island Lake           | 0.048       |
| Lac du Bonnet         | 0.049       |
| Lynn Lake             | 0.047       |
| Morden                | 0.049       |
| Neepawa               | 0.055       |
| Pine Falls            | 0.049       |
| Portage la Prairie    | 0.050       |
| Rivers                | 0.059       |
| Sandilands            | 0.047       |
| Selkirk               | 0.048       |
| Split Lake            | 0.047       |
| Steinbach             | 0.047       |
| Swan River            | 0.055       |
| The Pas               | 0.049       |
| Thompson              | 0.047       |
| Virten                | 0.065       |
| Winnipeg              | 0.047       |
| <b>Ontario</b>        |             |
| Ailsa Craig           | 0.109       |
| Ajax                  | 0.165       |
| Alexandria            | 0.295       |
| Alliston              | 0.135       |
| Almonte               | 0.239       |
| Armstrong             | 0.055       |
| Arnprior              | 0.245       |
| Atikokan              | 0.055       |
| Attawapiskat          | 0.064       |

\*  $S_{a,ICF}$  is calculated by Tacoma Engineers to simplify the design tables, for more information please see note 1.12 in design limitation section. Note: A professional engineer must design the ICF walls for locations where the  $S_{a,ICF}$  is not provided.

| Province and Location                 | S <sub>a,ICF</sub> |
|---------------------------------------|--------------------|
| <b>Ontario</b>                        |                    |
| Aurora                                | 0.145              |
| Bancroft                              | 0.181              |
| Barrie                                | 0.138              |
| Barrie/field                          | 0.189              |
| Beaverton                             | 0.147              |
| Belleville                            | 0.176              |
| Belmont                               | 0.119              |
| Kitchenuhmay-kooisib (Big Trout Lake) | 0.049              |
| CFB Borden                            | 0.135              |
| Bracebridge                           | 0.151              |
| Bradford                              | 0.141              |
| Brampton                              | 0.148              |
| Brantford                             | 0.138              |
| Brighton                              | 0.172              |
| Brockville                            | 0.226              |
| Burk's Falls                          | 0.164              |
| Burlington                            | 0.166              |
| Cambridge                             | 0.135              |
| Campbellford                          | 0.169              |
| Cannington                            | 0.149              |
| Carleton Place                        | 0.234              |
| Cavan                                 | 0.158              |
| Centralia                             | 0.109              |
| Chapleau                              | 0.082              |
| Chatham                               | 0.110              |
| Chesley                               | 0.113              |
| Clinton                               | 0.106              |
| Coboconk                              | 0.155              |
| Cobourg                               | 0.168              |
| Cochrane                              | 0.138              |
| Colborne                              | 0.171              |
| Collingwood                           | 0.129              |
| Cornwall                              | 0.293              |
| Corunna                               | 0.098              |
| Deep River                            | 0.241              |
| Deseronto                             | 0.180              |
| Dorchester                            | 0.119              |
| Dorion                                | 0.051              |
| Dresden                               | 0.107              |
| Dryden                                | 0.059              |
| Dundalk                               | 0.125              |
| Dunnville                             | 0.158              |
| Durham                                | 0.117              |
| Dutton                                | 0.115              |
| Earlton                               | 0.163              |
| Edison                                | 0.057              |
| Elm/Iot Lake                          | 0.093              |
| Elmvale                               | 0.136              |
| Embro                                 | 0.121              |
| Englehart                             | 0.159              |
| Espanola                              | 0.110              |
| Exeter                                | 0.109              |
| Fenelon Falls                         | 0.154              |
| Fergus                                | 0.129              |
| Forest                                | 0.103              |
| Fort Erie                             | 0.177              |

| Province and Location         | S <sub>a,ICF</sub> |
|-------------------------------|--------------------|
| Fort Erie (Ridgeway)          | 0.175              |
| Fort Frances                  | 0.052              |
| Gananoque                     | 0.199              |
| Geraldton                     | 0.053              |
| Glencoe                       | 0.111              |
| Goderich                      | 0.103              |
| Gore Bay                      | 0.094              |
| Graham                        | 0.057              |
| Gravenhurst (Muskoka Airport) | 0.148              |
| Grimsby                       | 0.174              |
| Guelph                        | 0.134              |
| Guthrie                       | 0.141              |
| Haileybury                    | 0.176              |
| Haldimand (Caledonia)         | 0.153              |
| Haldimand (Hagersville)       | 0.143              |
| Haliburton                    | 0.168              |
| Halton Hills (Georgetown)     | 0.143              |
| Hamilton                      | 0.164              |
| Hanover                       | 0.114              |
| Hastings                      | 0.167              |
| Hawkesbury                    | 0.282              |
| Hearst                        | 0.074              |
| Honey Harbour                 | 0.139              |
| Hornepayne                    | 0.066              |
| Huntsville                    | 0.159              |
| Ingersoll                     | 0.122              |
| Iroquois Falls                | 0.138              |
| Jellicoe                      | 0.053              |
| Kapuskasing                   | 0.097              |
| Kemptville                    | 0.257              |
| Kenora                        | 0.053              |
| Killaloe                      | 0.217              |
| Kincardine                    | 0.103              |
| Kingston                      | 0.189              |
| Kinmount                      | 0.159              |
| Kirkland Lake                 | 0.148              |
| Kitchener                     | 0.129              |
| Lakeland                      | 0.162              |
| Lansdowne House               | 0.052              |
| Leamington                    | 0.109              |
| Lindsay                       | 0.154              |
| Lion's Head                   | 0.112              |
| Listowel                      | 0.116              |
| London                        | 0.116              |
| Lucan                         | 0.111              |
| Maitland                      | 0.231              |
| Markdale                      | 0.121              |
| Markham                       | 0.156              |
| Martin                        | 0.058              |
| Matheson                      | 0.136              |
| Mattawa                       | 0.241              |
| Midland                       | 0.137              |
| Milton                        | 0.151              |
| Milverton                     | 0.117              |
| Minden                        | 0.161              |
| Mississauga                   | 0.159              |
| Mississauga (Lester B.        | 0.154              |

| Province and Location        | S <sub>a,ICF</sub> |
|------------------------------|--------------------|
| Pearson Int'l A)             |                    |
| Mississauga (Port Credit)    | 0.165              |
| Mitchell                     | 0.113              |
| Moosonee                     | 0.078              |
| Morrisburg                   | 0.281              |
| Mount Forest                 | 0.119              |
| Nakina                       | 0.054              |
| Nanticoke (Jarvis)           | 0.138              |
| Nanticoke (Port Dover)       | 0.134              |
| Napanee                      | 0.182              |
| New Liskeard                 | 0.173              |
| Newcastle                    | 0.165              |
| Newcastle (Bowmanville)      | 0.165              |
| Newmarket                    | 0.144              |
| Niagara Falls                | 0.181              |
| North Bay                    | 0.190              |
| Norwood                      | 0.166              |
| Oakville                     | 0.167              |
| Orangeville                  | 0.132              |
| Orillia                      | 0.144              |
| Oshawa                       | 0.164              |
| Ottawa (City Hall)           | 0.265              |
| Ottawa (Barrhaven)           | 0.261              |
| Ottawa (Kanata)              | 0.254              |
| Ottawa (M-C Int'l Airport)   | 0.266              |
| Ottawa (Orleans)             | 0.272              |
| Owen Sound                   | 0.116              |
| Pagwa River                  | 0.061              |
| Paris                        | 0.134              |
| Parkhill                     | 0.107              |
| Parry Sound                  | 0.142              |
| Pelham (Fonthill)            | 0.176              |
| Pembroke                     | 0.241              |
| Penetanguishene              | 0.136              |
| Perth                        | 0.217              |
| Petawawa                     | 0.239              |
| Peterborough                 | 0.160              |
| Petrolia                     | 0.103              |
| Pickering (Dunbarton)        | 0.166              |
| Picton                       | 0.175              |
| Plattsville                  | 0.126              |
| Point Alexander              | 0.240              |
| Port Burwell                 | 0.125              |
| Port Colborne                | 0.173              |
| Port Elgin                   | 0.107              |
| Port Hope                    | 0.167              |
| Port Perry                   | 0.153              |
| Port Stanley                 | 0.119              |
| Prescott                     | 0.246              |
| Princeton                    | 0.129              |
| Raith                        | 0.055              |
| Rayside-Balfour (Chelmsford) | 0.126              |
| Red Lake                     | 0.057              |
| Renfrew                      | 0.238              |
| Richmond Hill                | 0.150              |
| Rockland                     | 0.277              |
| Sarnia                       | 0.098              |

| Province and Location | S <sub>a,ICF</sub> |
|-----------------------|--------------------|
| Sault Ste. Marie      | 0.071              |
| Schreiber             | 0.052              |
| Seaforth              | 0.109              |
| Shelburne             | 0.129              |
| Simcoe                | 0.133              |
| Sioux Lookout         | 0.060              |
| Smiths Falls          | 0.225              |
| Smithville            | 0.172              |
| Smooth Rock Falls     | 0.127              |
| South River           | 0.171              |
| Southampton           | 0.108              |
| St. Catharines        | 0.179              |
| St. Mary's            | 0.115              |
| St. Thomas            | 0.118              |
| Stirling              | 0.173              |
| Stratford             | 0.118              |
| Strathroy             | 0.110              |
| Sturgeon Falls        | 0.169              |
| Sudbury               | 0.131              |
| Sundridge             | 0.168              |
| Tavistock             | 0.121              |
| Temagami              | 0.183              |
| Thamesford            | 0.119              |
| Theedford             | 0.104              |
| Thunder Bay           | 0.051              |
| Tillsonburg           | 0.125              |
| Timmins               | 0.118              |
| Timmins (Porcupine)   | 0.124              |
| Etobicoke             | 0.155              |
| North York            | 0.157              |
| Scarborough           | 0.164              |
| Toronto (City Hall)   | 0.168              |
| Trenton               | 0.174              |
| Trout Creek           | 0.176              |
| Uxbridge              | 0.150              |
| Vaughan (Woodbridge)  | 0.149              |
| Vittoria              | 0.132              |
| Walkerton             | 0.112              |
| Wallaceburg           | 0.104              |
| Waterloo              | 0.127              |
| Watford               | 0.106              |
| Wawa                  | 0.066              |
| Welland               | 0.175              |
| West Lorne            | 0.115              |
| Whitby                | 0.165              |
| Whitby (Brooklin)     | 0.159              |
| White River           | 0.063              |
| Warton                | 0.113              |
| Windsor               | 0.100              |
| Wingham               | 0.109              |
| Woodstock             | 0.124              |
| Wyoming               | 0.102              |
| <b>Quebec</b>         |                    |
| Acton-Vale            | 0.245              |
| Alma                  | 0.358              |
| Amos                  | 0.143              |
| Asbestos              | 0.236              |

\* S<sub>a,ICF</sub> is calculated by Tacoma Engineers to simplify the design tables, for more information please see note 1.12 in design limitation section. Note: A professional engineer must design the ICF walls for locations where the S<sub>a,ICF</sub> is not provided.

| Province and Location  | S <sub>a,ICF</sub> |
|------------------------|--------------------|
| <b>Quebec</b>          |                    |
| Aylmer                 | 0.259              |
| Baie-Comeau            | 0.253              |
| Baie-Saint-Paul        | 0.687              |
| Beauport               | 0.306              |
| Bedford                | 0.262              |
| Beloil                 | 0.283              |
| Brome                  | 0.237              |
| Brossard               | 0.295              |
| Buckingham             | 0.273              |
| Campbell's Bay         | 0.248              |
| Chambly                | 0.288              |
| Coaticook              | 0.226              |
| Contrecoeur            | 0.277              |
| Cowansville            | 0.246              |
| Deux-Montagnes         | 0.298              |
| Dolbeau                | 0.275              |
| Drummondville          | 0.251              |
| Farnham                | 0.263              |
| Fort-Coulonge          | 0.247              |
| Gagnon                 | 0.112              |
| Gaspe                  | 0.163              |
| Gatineau               | 0.266              |
| Gracefield             | 0.257              |
| Granby                 | 0.246              |
| Harrington-Harbour     | 0.090              |
| Havre-St-Pierre        | 0.164              |
| Hemmingford            | 0.290              |
| Hull                   | 0.264              |
| Iberville              | 0.284              |
| Inukjuak               | 0.063              |
| Joliette               | 0.275              |
| Kuujuaq                | 0.089              |
| Kuujuarapik            | 0.051              |
| La Pocatiere           | 0.651              |
| La-Malbaie             | 0.754              |
| La-Tuque               | 0.240              |
| Lac-Megantic           | 0.228              |
| Lachute                | 0.284              |
| Lennoxville            | 0.228              |
| Lery                   | 0.298              |
| Loretteville           | 0.302              |
| Louiseville            | 0.264              |
| Magog                  | 0.229              |
| Malartic               | 0.160              |
| Maniwaki               | 0.256              |
| Masson                 | 0.275              |
| Matane                 | 0.257              |
| Mont-Joli              | 0.270              |
| Mont-Laurier           | 0.254              |
| Montmagny              | 0.338              |
| <b>Montreal Region</b> |                    |
| Beaconsfield           | 0.299              |
| Dorval                 | 0.299              |
| Laval                  | 0.297              |
| Montreal (City Hall)   | 0.297              |
| Montreal-Est           | 0.295              |

| Province and Location           | S <sub>a,ICF</sub> |
|---------------------------------|--------------------|
| Montreal-Nord                   | 0.296              |
| Outremont                       | 0.297              |
| Pierrefonds                     | 0.298              |
| St-Lambert                      | 0.295              |
| St-Laurent                      | 0.298              |
| Ste-Anne-de-Bellevue            | 0.299              |
| Verdun                          | 0.297              |
| Nicolet (Gentilly)              | 0.269              |
| Nitchequon                      | 0.075              |
| Noranda                         | 0.148              |
| Perce                           | 0.156              |
| Pincourt                        | 0.299              |
| Ples s i s vil le               | 0.253              |
| Port-Cartier                    | 0.212              |
| Puvirnituaq                     | 0.086              |
| <b>Quebec City Region</b>       |                    |
| Ancienne-Lorette                | 0.298              |
| Levis                           | 0.301              |
| Quebec                          | 0.301              |
| Sil lery                        | 0.298              |
| Ste-Foy                         | 0.299              |
| Richmond                        | 0.236              |
| Rimouski                        | 0.277              |
| Riviere-du-Loup                 | 0.483              |
| Roberval                        | 0.312              |
| Rock-Island                     | 0.227              |
| Rosemere                        | 0.296              |
| Rouyn                           | 0.149              |
| Saguenay                        | 0.369              |
| Saguenay (Bagotville)           | 0.378              |
| Saguenay (Jonquiere)            | 0.372              |
| Saguenay (Kenogami)             | 0.372              |
| Saint-Eustache                  | 0.297              |
| Saint-Jean-sur-Richelieu        | 0.285              |
| Salaberry-de-Valleyfield        | 0.299              |
| Schefferville                   | 0.060              |
| Senneterre                      | 0.155              |
| Sept-Iles                       | 0.199              |
| Shawinigan                      | 0.258              |
| Shawville                       | 0.247              |
| Sherbrooke                      | 0.229              |
| Sorel                           | 0.269              |
| St-Felicien                     | 0.280              |
| St-Georges-de-Cacouna           | 0.401              |
| St-Hubert                       | 0.294              |
| Saint-Hubert-de-Riviere-du-Loup | 0.307              |
| St-Hyacinthe                    | 0.263              |
| St-JerOme                       | 0.287              |
| St-Jovite                       | 0.265              |
| St-Lazare-Hudson                | 0.298              |
| St-Nicolas                      | 0.292              |
| Ste-Agathe-des-Monts            | 0.267              |
| Sutton                          | 0.238              |
| Tadoussac                       | 0.354              |
| Terniscaming                    | 0.334              |
| Terrebonne                      | 0.295              |

| Province and Location | S <sub>a,ICF</sub> |
|-----------------------|--------------------|
| Theftord Mines        | 0.243              |
| Thurso                | 0.275              |
| Trois-Rivieres        | 0.267              |
| Val-d'Or              | 0.164              |
| Varenes               | 0.292              |
| Vercheres             | 0.286              |
| Victoriaville         | 0.247              |
| Vil le-Marie          | 0.191              |
| Wakefield             | 0.258              |
| Waterloo              | 0.237              |
| Windsor               | 0.232              |
| <b>New Brunswick</b>  |                    |
| Alma                  | 0.169              |
| Bathurst              | 0.200              |
| Campbellton           | 0.216              |
| Edmundston            | 0.252              |
| Fredericton           | 0.207              |
| Gagetown              | 0.197              |
| Grand Falls           | 0.239              |
| Miramichi             | 0.196              |
| Moncton               | 0.172              |
| Oromocto              | 0.204              |
| Sackville             | 0.162              |
| Saint Andrews         | 0.359              |
| Saint George          | 0.270              |
| Saint John            | 0.190              |
| Shippagan             | 0.171              |
| St. Stephen           | 0.321              |
| Woodstock             | 0.219              |
| <b>Nova Scotia</b>    |                    |
| Amherst               | 0.157              |
| Antigonish            | 0.140              |
| Bridgewater           | 0.148              |
| Canso                 | 0.152              |
| Debert                | 0.145              |
| Digby                 | 0.174              |
| Greenwood (CFB)       | 0.160              |
| Dartmouth             | 0.143              |
| Halifax               | 0.143              |
| Kentville             | 0.154              |
| Liverpool             | 0.147              |
| Lockeport             | 0.147              |
| Louisburg             | 0.161              |
| Lunenburg             | 0.147              |
| New Glasgow           | 0.141              |
| North Sydney          | 0.151              |
| Pictou                | 0.141              |
| Port Hawkesbury       | 0.145              |
| Springhill            | 0.152              |
| Stewiacke             | 0.144              |
| Sydney                | 0.151              |
| Tatamagouche          | 0.144              |
| Truro                 | 0.144              |
| Wolfville             | 0.153              |
| Yarmouth              | 0.160              |

| Province and Location       | S <sub>a,ICF</sub> |
|-----------------------------|--------------------|
| <b>Prince Edward Island</b> |                    |
| Charlottetown               | 0.143              |
| Souris                      | 0.136              |
| Summerside                  | 0.155              |
| Tignish                     | 0.158              |
| <b>Newfoundland</b>         |                    |
| Argentia                    | 0.151              |
| Bonavista                   | 0.123              |
| Buchans                     | 0.115              |
| Cape Harrison               | 0.149              |
| Cape Race                   | 0.161              |
| Channel-Port aux Basques    | 0.133              |
| Corner Brook                | 0.110              |
| Gander                      | 0.117              |
| Grand Bank                  | 0.167              |
| Grand Falls                 | 0.116              |
| Happy Valley - Goose Bay    | 0.082              |
| Labrador City               | 0.082              |
| St. Anthony                 | 0.093              |
| St. John's                  | 0.138              |
| Stephenville                | 0.115              |
| Twin Falls                  | 0.073              |
| Wabana                      | 0.138              |
| Wabush                      | 0.083              |

\* S<sub>a,ICF</sub> is calculated by Tacoma Engineers to simplify the design tables, for more information please see note 1.12 in design limitation section. Note: A professional engineer must design the ICF walls for locations where the S<sub>a,ICF</sub> is not provided.

# Appendix B: Climatic Design Data

**Table C-2**  
**Climatic Design Data for Selected Locations in Canada**

| Province and Location   | Elev., m | Design Temperature |       |           |        | Degree-Days Below 18°C | 15 Min. Rain, mm | One Day Rain, 1/50, mm | Ann. Rain, mm | Moist. Index | Ann. Tot. Ppn., mm | Driving Rain Wind Pressures, Pa, 1/5 | Snow Load, kPa, 1/50 |                | Hourly Wind Pressures, kPa |      |
|-------------------------|----------|--------------------|-------|-----------|--------|------------------------|------------------|------------------------|---------------|--------------|--------------------|--------------------------------------|----------------------|----------------|----------------------------|------|
|                         |          | January            |       | July 2.5% |        |                        |                  |                        |               |              |                    |                                      | S <sub>s</sub>       | S <sub>r</sub> | 1/10                       | 1/50 |
|                         |          | 2.5% °C            | 1% °C | Dry °C    | Wet °C |                        |                  |                        |               |              |                    |                                      |                      |                |                            |      |
| <b>British Columbia</b> |          |                    |       |           |        |                        |                  |                        |               |              |                    |                                      |                      |                |                            |      |
| 100 Mile House          | 1040     | -30                | -32   | 29        | 17     | 5030                   | 10               | 48                     | 300           | 0.4          | 425                | 60                                   | 2.6                  | 0.3            | 0.27                       | 0.35 |
| Abbotsford              | 70       | -8                 | -10   | 29        | 20     | 2860                   | 12               | 112                    | 1525          | 1.6          | 1600               | 160                                  | 2.0                  | 0.3            | 0.33                       | 0.44 |
| Agassiz                 | 15       | -9                 | -11   | 31        | 21     | 2750                   | 8                | 128                    | 1650          | 1.7          | 1700               | 160                                  | 2.4                  | 0.7            | 0.35                       | 0.47 |
| Alberni                 | 12       | -5                 | -8    | 31        | 19     | 3100                   | 10               | 144                    | 1900          | 2.0          | 2000               | 220                                  | 2.6                  | 0.4            | 0.24                       | 0.32 |
| Ashcroft                | 305      | -24                | -27   | 34        | 20     | 3700                   | 10               | 37                     | 250           | 0.3          | 300                | 80                                   | 1.7                  | 0.1            | 0.29                       | 0.38 |
| Bamfield                | 20       | -2                 | -4    | 23        | 17     | 3080                   | 13               | 170                    | 2870          | 3.0          | 2890               | 280                                  | 1.0                  | 0.4            | 0.38                       | 0.50 |
| Beaton River            | 840      | -37                | -39   | 26        | 18     | 6300                   | 15               | 64                     | 330           | 0.5          | 450                | 80                                   | 3.3                  | 0.1            | 0.23                       | 0.30 |
| Bella Bella             | 25       | -5                 | -7    | 23        | 18     | 3180                   | 13               | 145                    | 2715          | 2.8          | 2800               | 350                                  | 2.6                  | 0.8            | 0.40                       | 0.50 |
| Bella Coola             | 40       | -14                | -18   | 27        | 19     | 3560                   | 10               | 140                    | 1500          | 1.9          | 1700               | 350                                  | 4.5                  | 0.8            | 0.29                       | 0.39 |
| Burns Lake              | 755      | -31                | -34   | 26        | 17     | 5450                   | 12               | 54                     | 300           | 0.6          | 450                | 100                                  | 3.4                  | 0.2            | 0.29                       | 0.39 |
| Cache Creek             | 455      | -24                | -27   | 34        | 20     | 3700                   | 10               | 37                     | 250           | 0.3          | 300                | 80                                   | 1.7                  | 0.2            | 0.29                       | 0.39 |
| Campbell River          | 20       | -5                 | -7    | 26        | 18     | 3000                   | 10               | 116                    | 1500          | 1.6          | 1600               | 260                                  | 2.8                  | 0.4            | 0.41                       | 0.48 |
| Carmi                   | 845      | -24                | -26   | 31        | 19     | 4750                   | 10               | 64                     | 325           | 0.4          | 550                | 60                                   | 3.6                  | 0.2            | 0.29                       | 0.38 |
| Castlegar               | 430      | -18                | -20   | 32        | 20     | 3580                   | 10               | 54                     | 560           | 0.6          | 700                | 60                                   | 4.2                  | 0.1            | 0.26                       | 0.34 |
| Chetwynd                | 605      | -35                | -38   | 27        | 18     | 5500                   | 15               | 70                     | 400           | 0.6          | 625                | 60                                   | 2.4                  | 0.2            | 0.30                       | 0.40 |
| Chilliwack              | 10       | -9                 | -11   | 30        | 20     | 2780                   | 8                | 139                    | 1625          | 1.7          | 1700               | 160                                  | 2.2                  | 0.3            | 0.35                       | 0.47 |
| Comox                   | 15       | -7                 | -9    | 27        | 18     | 2930                   | 10               | 106                    | 1175          | 1.3          | 1200               | 260                                  | 2.4                  | 0.4            | 0.41                       | 0.48 |
| Courtenay               | 10       | -7                 | -9    | 28        | 18     | 2930                   | 10               | 106                    | 1400          | 1.5          | 1450               | 260                                  | 2.4                  | 0.4            | 0.41                       | 0.48 |
| Cranbrook               | 910      | -26                | -28   | 32        | 18     | 4400                   | 12               | 59                     | 275           | 0.3          | 400                | 100                                  | 3.0                  | 0.2            | 0.25                       | 0.33 |
| Crescent Valley         | 585      | -18                | -20   | 31        | 20     | 3650                   | 10               | 54                     | 675           | 0.8          | 850                | 80                                   | 4.2                  | 0.1            | 0.25                       | 0.33 |
| Crofton                 | 5        | -4                 | -6    | 28        | 19     | 2880                   | 8                | 86                     | 925           | 1.1          | 950                | 160                                  | 1.8                  | 0.2            | 0.32                       | 0.40 |
| Dawson Creek            | 665      | -38                | -40   | 27        | 18     | 5900                   | 18               | 75                     | 325           | 0.5          | 475                | 100                                  | 2.5                  | 0.2            | 0.30                       | 0.40 |
| Dease Lake              | 800      | -37                | -40   | 24        | 15     | 6730                   | 10               | 45                     | 265           | 0.6          | 425                | 50                                   | 2.8                  | 0.1            | 0.23                       | 0.30 |
| Dog Creek               | 450      | -28                | -30   | 29        | 17     | 4800                   | 10               | 48                     | 275           | 0.4          | 375                | 100                                  | 1.8                  | 0.2            | 0.27                       | 0.35 |
| Duncan                  | 10       | -6                 | -8    | 28        | 19     | 2980                   | 8                | 103                    | 1000          | 1.1          | 1050               | 180                                  | 1.8                  | 0.4            | 0.31                       | 0.39 |
| Elko                    | 1065     | -28                | -31   | 30        | 19     | 4600                   | 13               | 64                     | 440           | 0.5          | 650                | 100                                  | 3.6                  | 0.2            | 0.30                       | 0.40 |

Table C-2 (Continued)

| Province and Location | Elev., m | Design Temperature |      |             |                | Degree-Days Below 18°C | 15 Min. Rain, mm | One Day Rain, 1/50, mm | Ann. Rain, mm | Moist. Index | Ann. Tot. Ppr., mm | Driving Rain Wind Pressures, Pa, 1/5 | Snow Load, kPa, 1/50 |      | Hourly Wind Pressures, kPa |         |
|-----------------------|----------|--------------------|------|-------------|----------------|------------------------|------------------|------------------------|---------------|--------------|--------------------|--------------------------------------|----------------------|------|----------------------------|---------|
|                       |          | January            | July | 2.5% Wet °C | S <sub>s</sub> |                        |                  |                        |               |              |                    |                                      | S <sub>r</sub>       | 1/10 | 1/50                       |         |
|                       |          |                    |      |             |                |                        |                  |                        |               |              |                    |                                      |                      |      |                            | 2.5% °C |
| Fernie                | 1010     | -27                | -30  | 30          | 19             | 4750                   | 13               | 118                    | 860           | 0.9          | 1175               | 100                                  | 4.5                  | 0.2  | 0.30                       | 0.40    |
| Fort Nelson           | 465      | -39                | -42  | 28          | 18             | 6710                   | 15               | 70                     | 325           | 0.6          | 450                | 80                                   | 2.4                  | 0.1  | 0.23                       | 0.30    |
| Fort St. John         | 685      | -35                | -37  | 26          | 18             | 5750                   | 15               | 72                     | 320           | 0.5          | 475                | 100                                  | 2.8                  | 0.1  | 0.29                       | 0.39    |
| Glacier               | 1145     | -27                | -30  | 27          | 17             | 5800                   | 10               | 70                     | 625           | 0.8          | 1500               | 80                                   | 9.4                  | 0.2  | 0.24                       | 0.32    |
| Golden                | 790      | -27                | -30  | 30          | 17             | 4750                   | 10               | 55                     | 325           | 0.6          | 500                | 100                                  | 3.7                  | 0.2  | 0.26                       | 0.35    |
| Gold River            | 120      | -8                 | -11  | 31          | 18             | 3230                   | 13               | 200                    | 2730          | 2.8          | 2850               | 250                                  | 2.8                  | 0.6  | 0.24                       | 0.32    |
| Grand Forks           | 565      | -19                | -22  | 34          | 20             | 3820                   | 10               | 48                     | 390           | 0.5          | 475                | 80                                   | 2.8                  | 0.1  | 0.30                       | 0.40    |
| Greenwood             | 745      | -20                | -23  | 34          | 20             | 4100                   | 10               | 64                     | 430           | 0.5          | 550                | 80                                   | 3.6                  | 0.1  | 0.30                       | 0.40    |
| Hope                  | 40       | -13                | -15  | 31          | 20             | 2820                   | 8                | 139                    | 1825          | 1.9          | 1900               | 140                                  | 2.8                  | 0.7  | 0.47                       | 0.63    |
| Jordan River          | 20       | -1                 | -3   | 22          | 17             | 2900                   | 12               | 170                    | 2300          | 2.4          | 2370               | 250                                  | 1.2                  | 0.4  | 0.44                       | 0.55    |
| Kamloops              | 355      | -23                | -25  | 34          | 20             | 3450                   | 13               | 42                     | 225           | 0.2          | 275                | 80                                   | 1.8                  | 0.2  | 0.30                       | 0.40    |
| Kaslo                 | 545      | -17                | -20  | 30          | 19             | 3830                   | 10               | 55                     | 660           | 0.8          | 850                | 80                                   | 2.8                  | 0.1  | 0.23                       | 0.31    |
| Kelowna               | 350      | -17                | -20  | 33          | 20             | 3400                   | 12               | 43                     | 260           | 0.3          | 325                | 80                                   | 1.7                  | 0.1  | 0.30                       | 0.40    |
| Kimberley             | 1090     | -25                | -27  | 31          | 18             | 4650                   | 12               | 59                     | 350           | 0.4          | 500                | 100                                  | 3.0                  | 0.2  | 0.25                       | 0.33    |
| Kitimat Plant         | 15       | -16                | -18  | 25          | 16             | 3750                   | 13               | 193                    | 2100          | 2.2          | 2500               | 220                                  | 5.5                  | 0.8  | 0.36                       | 0.48    |
| Kitimat Townsite      | 130      | -16                | -18  | 24          | 16             | 3900                   | 13               | 171                    | 1900          | 2.0          | 2300               | 220                                  | 6.5                  | 0.8  | 0.36                       | 0.48    |
| Ladysmith             | 80       | -7                 | -9   | 27          | 19             | 2920                   | 8                | 97                     | 1075          | 1.2          | 1160               | 180                                  | 2.4                  | 0.4  | 0.32                       | 0.40    |
| Langford              | 80       | -4                 | -6   | 27          | 19             | 2750                   | 9                | 135                    | 1095          | 1.2          | 1125               | 220                                  | 1.8                  | 0.3  | 0.32                       | 0.40    |
| Lillooet              | 245      | -21                | -23  | 34          | 20             | 3400                   | 10               | 70                     | 300           | 0.3          | 350                | 100                                  | 2.1                  | 0.1  | 0.33                       | 0.44    |
| Lytton                | 325      | -17                | -20  | 35          | 20             | 3300                   | 10               | 70                     | 330           | 0.3          | 425                | 80                                   | 2.8                  | 0.3  | 0.32                       | 0.43    |
| Mackenzie             | 765      | -34                | -38  | 27          | 17             | 5550                   | 10               | 50                     | 350           | 0.5          | 650                | 60                                   | 5.1                  | 0.2  | 0.25                       | 0.32    |
| Masset                | 10       | -5                 | -7   | 17          | 15             | 3700                   | 13               | 80                     | 1350          | 1.5          | 1400               | 400                                  | 1.8                  | 0.4  | 0.50                       | 0.61    |
| McBride               | 730      | -29                | -32  | 29          | 18             | 4980                   | 13               | 54                     | 475           | 0.6          | 650                | 60                                   | 4.3                  | 0.2  | 0.27                       | 0.35    |
| McLeod Lake           | 695      | -35                | -37  | 27          | 17             | 5450                   | 10               | 50                     | 350           | 0.5          | 650                | 60                                   | 4.1                  | 0.2  | 0.25                       | 0.32    |
| Merritt               | 570      | -24                | -27  | 34          | 20             | 3900                   | 8                | 54                     | 240           | 0.2          | 310                | 80                                   | 1.8                  | 0.3  | 0.33                       | 0.44    |
| Mission City          | 45       | -9                 | -11  | 30          | 20             | 2850                   | 13               | 123                    | 1650          | 1.7          | 1700               | 160                                  | 2.4                  | 0.3  | 0.32                       | 0.43    |
| Montrose              | 615      | -16                | -18  | 32          | 20             | 3600                   | 10               | 54                     | 480           | 0.6          | 700                | 60                                   | 4.1                  | 0.1  | 0.26                       | 0.35    |
| Nakusp                | 445      | -20                | -22  | 31          | 20             | 3560                   | 10               | 60                     | 650           | 0.8          | 850                | 60                                   | 4.4                  | 0.1  | 0.25                       | 0.33    |

Table C-2 (Continued)

Table C-2 (Continued)

| Province and Location | Elev., m | Design Temperature |       |           |        | Degree-Days Below 18°C | 15 Min. Rain, mm | One Day Rain, 1/50, mm | Ann. Rain, mm | Moist. Index | Ann. Tot. Ppn., mm | Driving Wind Pressures, Pa, 1/5 | Snow Load, kPa, 1/50 |                | Hourly Wind Pressures, kPa |      |
|-----------------------|----------|--------------------|-------|-----------|--------|------------------------|------------------|------------------------|---------------|--------------|--------------------|---------------------------------|----------------------|----------------|----------------------------|------|
|                       |          | January            |       | July 2.5% |        |                        |                  |                        |               |              |                    |                                 | S <sub>s</sub>       | S <sub>r</sub> | 1/10                       | 1/50 |
|                       |          | 2.5% °C            | 1% °C | Dry °C    | Wet °C |                        |                  |                        |               |              |                    |                                 |                      |                |                            |      |
| Nanaimo               | 15       | -6                 | -8    | 27        | 19     | 2920                   | 10               | 91                     | 1000          | 1.1          | 1050               | 200                             | 2.1                  | 0.4            | 0.38                       | 0.48 |
| Nelson                | 600      | -18                | -20   | 31        | 20     | 3500                   | 10               | 59                     | 460           | 0.6          | 700                | 60                              | 4.2                  | 0.1            | 0.25                       | 0.33 |
| Ocean Falls           | 10       | -10                | -12   | 23        | 17     | 3400                   | 13               | 260                    | 4150          | 4.2          | 4300               | 350                             | 3.9                  | 0.8            | 0.44                       | 0.59 |
| Osoyoos               | 285      | -14                | -17   | 35        | 21     | 3100                   | 10               | 48                     | 275           | 0.3          | 310                | 60                              | 1.1                  | 0.1            | 0.30                       | 0.40 |
| Parksville            | 40       | -6                 | -8    | 26        | 19     | 2990                   | 10               | 91                     | 1200          | 1.3          | 1250               | 200                             | 2.0                  | 0.4            | 0.40                       | 0.48 |
| Penticton             | 350      | -15                | -17   | 33        | 20     | 3350                   | 10               | 48                     | 275           | 0.3          | 300                | 60                              | 1.3                  | 0.1            | 0.30                       | 0.40 |
| Port Alberni          | 15       | -5                 | -8    | 31        | 19     | 3100                   | 10               | 161                    | 1900          | 2.0          | 2000               | 240                             | 2.6                  | 0.4            | 0.24                       | 0.32 |
| Port Alice            | 25       | -3                 | -6    | 26        | 17     | 3010                   | 13               | 200                    | 3300          | 3.4          | 3340               | 220                             | 1.1                  | 0.4            | 0.24                       | 0.32 |
| Port Hardy            | 5        | -5                 | -7    | 20        | 16     | 3440                   | 13               | 150                    | 1775          | 1.9          | 1850               | 220                             | 0.9                  | 0.4            | 0.36                       | 0.48 |
| Port McNeill          | 5        | -5                 | -7    | 22        | 17     | 3410                   | 13               | 128                    | 1750          | 1.9          | 1850               | 260                             | 1.1                  | 0.4            | 0.36                       | 0.48 |
| Port Renfrew          | 20       | -3                 | -5    | 24        | 17     | 2900                   | 13               | 200                    | 3600          | 3.6          | 3675               | 270                             | 1.1                  | 0.4            | 0.42                       | 0.52 |
| Powell River          | 10       | -7                 | -9    | 26        | 18     | 3100                   | 10               | 80                     | 1150          | 1.3          | 1200               | 220                             | 1.7                  | 0.4            | 0.39                       | 0.48 |
| Prince George         | 580      | -32                | -36   | 28        | 18     | 4720                   | 15               | 54                     | 425           | 0.6          | 600                | 80                              | 3.4                  | 0.2            | 0.28                       | 0.37 |
| Prince Rupert         | 20       | -13                | -15   | 19        | 15     | 3900                   | 13               | 160                    | 2750          | 2.8          | 2900               | 240                             | 1.9                  | 0.4            | 0.43                       | 0.54 |
| Princeton             | 655      | -24                | -29   | 33        | 19     | 4250                   | 10               | 43                     | 235           | 0.4          | 350                | 80                              | 2.9                  | 0.6            | 0.27                       | 0.36 |
| Qualicum Beach        | 10       | -7                 | -9    | 27        | 19     | 2990                   | 10               | 96                     | 1200          | 1.3          | 1250               | 200                             | 2.0                  | 0.4            | 0.41                       | 0.48 |
| Queen Charlotte City  | 35       | -6                 | -8    | 21        | 16     | 3520                   | 13               | 110                    | 1300          | 1.5          | 1350               | 360                             | 1.8                  | 0.4            | 0.50                       | 0.61 |
| Quesnel               | 475      | -31                | -33   | 30        | 17     | 4650                   | 10               | 50                     | 380           | 0.5          | 525                | 80                              | 3.0                  | 0.1            | 0.24                       | 0.31 |
| Revelstoke            | 440      | -20                | -23   | 31        | 19     | 4000                   | 13               | 55                     | 625           | 0.8          | 950                | 80                              | 7.2                  | 0.1            | 0.24                       | 0.32 |
| Salmon Arm            | 425      | -19                | -24   | 33        | 21     | 3650                   | 13               | 48                     | 400           | 0.5          | 525                | 80                              | 3.5                  | 0.1            | 0.29                       | 0.39 |
| Sandspit              | 5        | -4                 | -6    | 18        | 15     | 3450                   | 13               | 86                     | 1300          | 1.5          | 1350               | 500                             | 1.8                  | 0.4            | 0.59                       | 0.72 |
| Sechelt               | 25       | -6                 | -8    | 27        | 20     | 2880                   | 10               | 75                     | 1140          | 1.3          | 1200               | 160                             | 1.8                  | 0.4            | 0.38                       | 0.48 |
| Sidney                | 10       | -4                 | -6    | 26        | 18     | 2850                   | 8                | 96                     | 825           | 1.0          | 850                | 160                             | 1.1                  | 0.2            | 0.34                       | 0.42 |
| Smithers              | 500      | -29                | -31   | 26        | 17     | 5040                   | 13               | 60                     | 325           | 0.6          | 500                | 120                             | 3.5                  | 0.2            | 0.30                       | 0.40 |
| Smith River           | 660      | -45                | -47   | 26        | 17     | 7100                   | 10               | 64                     | 300           | 0.6          | 500                | 40                              | 2.8                  | 0.1            | 0.24                       | 0.30 |
| Sooke                 | 20       | -1                 | -3    | 21        | 16     | 2900                   | 9                | 130                    | 1250          | 1.4          | 1280               | 220                             | 1.3                  | 0.3            | 0.38                       | 0.48 |
| Squamish              | 5        | -9                 | -11   | 29        | 20     | 2950                   | 10               | 140                    | 2050          | 2.1          | 2200               | 160                             | 2.8                  | 0.7            | 0.38                       | 0.50 |
| Stewart               | 10       | -17                | -20   | 25        | 16     | 4350                   | 13               | 135                    | 1300          | 1.5          | 1900               | 180                             | 7.9                  | 0.8            | 0.27                       | 0.36 |

Table C-2 (Continued)

Table C-2 (Continued)

| Province and Location                | Elev., m | Design Temperature |       |           |        | Degree-Days Below 18°C | 15 Min. Rain, mm | One Day Rain, 1/50, mm | Ann. Rain, mm | Moist. Index | Ann. Tot. Ppn., mm | Driving Rain Wind Pressures, Pa, 1/5 | Snow Load, kPa, |                | Hourly Wind Pressures, kPa |      |
|--------------------------------------|----------|--------------------|-------|-----------|--------|------------------------|------------------|------------------------|---------------|--------------|--------------------|--------------------------------------|-----------------|----------------|----------------------------|------|
|                                      |          | January            |       | July 2.5% |        |                        |                  |                        |               |              |                    |                                      | S <sub>s</sub>  | S <sub>t</sub> | 1/10                       | 1/50 |
|                                      |          | 2.5% °C            | 1% °C | Dry °C    | Wet °C |                        |                  |                        |               |              |                    |                                      |                 |                |                            |      |
| Tahsis                               | 25       | -4                 | -6    | 26        | 18     | 3150                   | 13               | 200                    | 3845          | 3.9          | 3900               | 300                                  | 1.1             | 0.4            | 0.26                       | 0.34 |
| Taylor                               | 515      | -35                | -37   | 26        | 18     | 5720                   | 15               | 72                     | 320           | 0.5          | 450                | 100                                  | 2.3             | 0.1            | 0.30                       | 0.40 |
| Terrace                              | 60       | -19                | -21   | 27        | 17     | 4150                   | 13               | 120                    | 950           | 1.1          | 1150               | 200                                  | 5.4             | 0.6            | 0.27                       | 0.36 |
| Tofino                               | 10       | -2                 | -4    | 20        | 16     | 3150                   | 13               | 193                    | 3275          | 3.4          | 3300               | 300                                  | 1.1             | 0.4            | 0.51                       | 0.68 |
| Trail                                | 440      | -14                | -17   | 33        | 20     | 3600                   | 10               | 54                     | 580           | 0.7          | 700                | 60                                   | 4.1             | 0.1            | 0.26                       | 0.35 |
| Ucluelet                             | 5        | -2                 | -4    | 18        | 16     | 3120                   | 13               | 180                    | 3175          | 3.3          | 3200               | 280                                  | 1.0             | 0.4            | 0.51                       | 0.68 |
| Vancouver Region                     |          |                    |       |           |        |                        |                  |                        |               |              |                    |                                      |                 |                |                            |      |
| Burnaby (Simon Fraser Univ.)         | 330      | -7                 | -9    | 25        | 17     | 3100                   | 10               | 150                    | 1850          | 1.9          | 1950               | 160                                  | 2.9             | 0.7            | 0.35                       | 0.47 |
| Cloverdale                           | 10       | -8                 | -10   | 29        | 20     | 2700                   | 10               | 112                    | 1350          | 1.4          | 1400               | 160                                  | 2.5             | 0.2            | 0.33                       | 0.44 |
| Haney                                | 10       | -9                 | -11   | 30        | 20     | 2840                   | 10               | 134                    | 1800          | 1.9          | 1950               | 160                                  | 2.4             | 0.2            | 0.33                       | 0.44 |
| Ladner                               | 3        | -6                 | -8    | 27        | 19     | 2600                   | 10               | 80                     | 1000          | 1.1          | 1050               | 160                                  | 1.3             | 0.2            | 0.37                       | 0.46 |
| Langley                              | 15       | -8                 | -10   | 29        | 20     | 2700                   | 10               | 112                    | 1450          | 1.5          | 1500               | 160                                  | 2.4             | 0.2            | 0.33                       | 0.44 |
| New Westminster                      | 10       | -8                 | -10   | 29        | 19     | 2800                   | 10               | 134                    | 1500          | 1.6          | 1575               | 160                                  | 2.3             | 0.2            | 0.33                       | 0.44 |
| North Vancouver                      | 135      | -7                 | -9    | 26        | 19     | 2910                   | 12               | 150                    | 2000          | 2.1          | 2100               | 160                                  | 3.0             | 0.3            | 0.34                       | 0.45 |
| Richmond                             | 5        | -7                 | -9    | 27        | 19     | 2800                   | 10               | 86                     | 1070          | 1.2          | 1100               | 160                                  | 1.5             | 0.2            | 0.36                       | 0.45 |
| Surrey (88 Ave & 156 St.)            | 90       | -8                 | -10   | 29        | 20     | 2750                   | 10               | 128                    | 1500          | 1.6          | 1575               | 160                                  | 2.4             | 0.3            | 0.33                       | 0.44 |
| Vancouver (City Hall)                | 40       | -7                 | -9    | 28        | 20     | 2825                   | 10               | 112                    | 1325          | 1.4          | 1400               | 160                                  | 1.8             | 0.2            | 0.34                       | 0.45 |
| Vancouver (Granville St. & 41st Ave) | 120      | -6                 | -8    | 28        | 20     | 2925                   | 10               | 107                    | 1325          | 1.4          | 1400               | 160                                  | 1.9             | 0.3            | 0.36                       | 0.45 |
| West Vancouver                       | 45       | -7                 | -9    | 28        | 19     | 2950                   | 12               | 150                    | 1600          | 1.7          | 1700               | 160                                  | 2.4             | 0.2            | 0.36                       | 0.48 |
| Vernon                               | 405      | -20                | -23   | 33        | 20     | 3600                   | 13               | 43                     | 350           | 0.4          | 400                | 80                                   | 2.2             | 0.1            | 0.30                       | 0.40 |
| Victoria Region                      |          |                    |       |           |        |                        |                  |                        |               |              |                    |                                      |                 |                |                            |      |
| Victoria                             | 10       | -4                 | -6    | 24        | 17     | 2650                   | 8                | 91                     | 800           | 1.0          | 825                | 220                                  | 1.1             | 0.2            | 0.46                       | 0.57 |
| Victoria (Gonzales Hts)              | 65       | -4                 | -6    | 24        | 17     | 2700                   | 9                | 91                     | 600           | 0.8          | 625                | 220                                  | 1.5             | 0.3            | 0.46                       | 0.57 |

Table C-2 (Continued)

| Province and Location | Elev., m | Design Temperature |               |                  |                  | Degree-Days Below 18°C | 15 Min. Rain, mm | One Day Rain, 1/50, mm | Ann. Rain, mm | Moist. Index | Ann. Tot. Ppn., mm | Driving Wind Pressures, Pa, 1/5 | Snow Load, kPa, 1/50 |                | Hourly Wind Pressures, kPa |      |
|-----------------------|----------|--------------------|---------------|------------------|------------------|------------------------|------------------|------------------------|---------------|--------------|--------------------|---------------------------------|----------------------|----------------|----------------------------|------|
|                       |          | January 2.5% °C    | January 1% °C | July 2.5% Dry °C | July 2.5% Wet °C |                        |                  |                        |               |              |                    |                                 | S <sub>s</sub>       | S <sub>r</sub> | 1/10                       | 1/50 |
| Victoria (Mt Tolmie)  | 125      | -6                 | -8            | 24               | 16               | 2700                   | 9                | 91                     | 775           | 1.0          | 800                | 220                             | 2.1                  | 0.3            | 0.46                       | 0.57 |
| Whistler              | 665      | -17                | -20           | 30               | 20               | 4180                   | 10               | 85                     | 845           | 1.0          | 1215               | 160                             | 9.5                  | 0.9            | 0.24                       | 0.32 |
| White Rock            | 30       | -5                 | -7            | 25               | 20               | 2620                   | 10               | 80                     | 1065          | 1.2          | 1100               | 160                             | 2.0                  | 0.2            | 0.33                       | 0.44 |
| Williams Lake         | 615      | -30                | -33           | 29               | 17               | 4400                   | 10               | 48                     | 350           | 0.5          | 425                | 80                              | 2.4                  | 0.2            | 0.27                       | 0.35 |
| Youbou                | 200      | -5                 | -8            | 31               | 19               | 3050                   | 10               | 161                    | 2000          | 2.1          | 2100               | 200                             | 3.5                  | 0.7            | 0.26                       | 0.32 |
| <b>Alberta</b>        |          |                    |               |                  |                  |                        |                  |                        |               |              |                    |                                 |                      |                |                            |      |
| Athabasca             | 515      | -35                | -38           | 27               | 19               | 6000                   | 18               | 86                     | 370           | 0.6          | 480                | 80                              | 1.5                  | 0.1            | 0.27                       | 0.36 |
| Banff                 | 1400     | -31                | -33           | 27               | 16               | 5500                   | 18               | 65                     | 300           | 0.6          | 500                | 120                             | 3.3                  | 0.1            | 0.26                       | 0.32 |
| Barrhead              | 645      | -33                | -36           | 27               | 19               | 5740                   | 20               | 86                     | 375           | 0.6          | 475                | 100                             | 1.7                  | 0.1            | 0.35                       | 0.44 |
| Beaverfodge           | 730      | -36                | -39           | 28               | 18               | 5700                   | 20               | 86                     | 315           | 0.5          | 470                | 100                             | 2.4                  | 0.1            | 0.27                       | 0.36 |
| Brooks                | 760      | -32                | -34           | 32               | 20               | 4880                   | 18               | 86                     | 260           | 0.3          | 340                | 220                             | 1.2                  | 0.1            | 0.35                       | 0.44 |
| Calgary               | 1045     | -30                | -32           | 28               | 17               | 5000                   | 23               | 103                    | 325           | 0.4          | 425                | 220                             | 1.1                  | 0.1            | 0.38                       | 0.48 |
| Campsie               | 660      | -33                | -36           | 27               | 19               | 5750                   | 20               | 86                     | 375           | 0.6          | 475                | 100                             | 1.7                  | 0.1            | 0.33                       | 0.44 |
| Camrose               | 740      | -33                | -35           | 29               | 19               | 5500                   | 20               | 86                     | 355           | 0.5          | 470                | 160                             | 2.0                  | 0.1            | 0.31                       | 0.39 |
| Canmore               | 1320     | -31                | -33           | 28               | 17               | 5400                   | 18               | 86                     | 325           | 0.6          | 500                | 120                             | 3.2                  | 0.1            | 0.30                       | 0.37 |
| Cardston              | 1130     | -29                | -32           | 30               | 19               | 4700                   | 20               | 108                    | 340           | 0.4          | 550                | 140                             | 1.5                  | 0.1            | 0.58                       | 0.72 |
| Claresholm            | 1030     | -30                | -32           | 30               | 18               | 4680                   | 15               | 97                     | 310           | 0.4          | 440                | 200                             | 1.3                  | 0.1            | 0.46                       | 0.58 |
| Cold Lake             | 540      | -35                | -38           | 28               | 19               | 5860                   | 18               | 81                     | 320           | 0.5          | 430                | 140                             | 1.7                  | 0.1            | 0.29                       | 0.38 |
| Coleman               | 1320     | -31                | -34           | 29               | 18               | 5210                   | 15               | 86                     | 400           | 0.5          | 550                | 120                             | 2.7                  | 0.3            | 0.50                       | 0.63 |
| Coronation            | 790      | -32                | -34           | 30               | 19               | 5640                   | 20               | 92                     | 300           | 0.5          | 400                | 200                             | 1.9                  | 0.1            | 0.30                       | 0.37 |
| Cowley                | 1175     | -29                | -32           | 29               | 18               | 4810                   | 15               | 92                     | 310           | 0.4          | 525                | 140                             | 1.6                  | 0.1            | 0.81                       | 1.01 |
| Drumheller            | 685      | -32                | -34           | 30               | 18               | 5050                   | 20               | 86                     | 300           | 0.4          | 375                | 220                             | 1.2                  | 0.1            | 0.35                       | 0.44 |
| Edmonton              | 645      | -30                | -33           | 28               | 19               | 5120                   | 23               | 97                     | 360           | 0.5          | 460                | 160                             | 1.7                  | 0.1            | 0.36                       | 0.45 |
| Edson                 | 920      | -34                | -37           | 27               | 18               | 5750                   | 18               | 81                     | 450           | 0.6          | 570                | 100                             | 2.1                  | 0.1            | 0.37                       | 0.46 |
| Embaras Portage       | 220      | -41                | -43           | 28               | 19               | 7100                   | 12               | 81                     | 250           | 0.6          | 390                | 80                              | 2.2                  | 0.1            | 0.28                       | 0.37 |
| Fairview              | 670      | -37                | -40           | 27               | 18               | 5840                   | 15               | 86                     | 330           | 0.5          | 450                | 100                             | 2.4                  | 0.1            | 0.26                       | 0.35 |
| Fort MacLeod          | 945      | -30                | -32           | 31               | 19               | 4600                   | 16               | 97                     | 300           | 0.4          | 425                | 180                             | 1.2                  | 0.1            | 0.54                       | 0.68 |

Table C-2 (Continued)

Table C-2 (Continued)

| Province and Location | Elev., m | Design Temperature |       |           |        | Degree-Days Below 18°C | 15 Min. Rain, mm | One Day Rain, 1/50, mm | Ann. Rain, mm | Moist. Index | Ann. Tot. Ppn., mm | Driving Wind Pressures, Pa, 1/5 | Snow Load, kPa, 1/50 |                | Hourly Wind Pressures, kPa |      |
|-----------------------|----------|--------------------|-------|-----------|--------|------------------------|------------------|------------------------|---------------|--------------|--------------------|---------------------------------|----------------------|----------------|----------------------------|------|
|                       |          | January            |       | July 2.5% |        |                        |                  |                        |               |              |                    |                                 | S <sub>s</sub>       | S <sub>r</sub> | 1/10                       | 1/50 |
|                       |          | 2.5% °C            | 1% °C | Dry °C    | Wet °C |                        |                  |                        |               |              |                    |                                 |                      |                |                            |      |
| Fort McMurray         | 255      | -38                | -40   | 28        | 19     | 6250                   | 13               | 86                     | 340           | 0.5          | 460                | 60                              | 1.5                  | 0.1            | 0.28                       | 0.35 |
| Fort Saskatchewan     | 610      | -32                | -35   | 28        | 19     | 5420                   | 20               | 86                     | 350           | 0.5          | 425                | 140                             | 1.6                  | 0.1            | 0.34                       | 0.43 |
| Fort Vermilion        | 270      | -41                | -43   | 28        | 18     | 6700                   | 13               | 70                     | 250           | 0.5          | 380                | 60                              | 2.1                  | 0.1            | 0.23                       | 0.30 |
| Grande Prairie        | 650      | -36                | -39   | 27        | 18     | 5790                   | 20               | 86                     | 315           | 0.5          | 450                | 120                             | 2.2                  | 0.1            | 0.32                       | 0.43 |
| Habay                 | 335      | -41                | -43   | 28        | 18     | 6750                   | 13               | 70                     | 275           | 0.5          | 425                | 60                              | 2.4                  | 0.1            | 0.23                       | 0.30 |
| Hardisty              | 615      | -33                | -36   | 30        | 19     | 5640                   | 20               | 81                     | 325           | 0.5          | 425                | 140                             | 1.7                  | 0.1            | 0.29                       | 0.36 |
| High River            | 1040     | -31                | -32   | 28        | 17     | 4900                   | 18               | 97                     | 300           | 0.4          | 425                | 200                             | 1.3                  | 0.1            | 0.52                       | 0.65 |
| Hinton                | 990      | -34                | -38   | 27        | 17     | 5500                   | 13               | 81                     | 375           | 0.6          | 500                | 100                             | 2.6                  | 0.1            | 0.37                       | 0.46 |
| Jasper                | 1060     | -31                | -34   | 28        | 17     | 5300                   | 12               | 76                     | 300           | 0.5          | 400                | 80                              | 3.0                  | 0.1            | 0.26                       | 0.32 |
| Keg River             | 420      | -40                | -42   | 28        | 18     | 6520                   | 13               | 70                     | 310           | 0.5          | 450                | 80                              | 2.4                  | 0.1            | 0.23                       | 0.30 |
| Lac La Biche          | 560      | -35                | -38   | 28        | 19     | 6100                   | 15               | 86                     | 375           | 0.6          | 475                | 80                              | 1.6                  | 0.1            | 0.27                       | 0.36 |
| Lacombe               | 855      | -33                | -36   | 28        | 19     | 5500                   | 23               | 92                     | 350           | 0.5          | 450                | 180                             | 1.9                  | 0.1            | 0.32                       | 0.40 |
| Lethbridge            | 910      | -30                | -32   | 31        | 19     | 4500                   | 20               | 97                     | 250           | 0.3          | 390                | 200                             | 1.2                  | 0.1            | 0.53                       | 0.66 |
| Manning               | 465      | -39                | -41   | 27        | 18     | 6300                   | 13               | 76                     | 280           | 0.5          | 390                | 80                              | 2.3                  | 0.1            | 0.23                       | 0.30 |
| Medicine Hat          | 705      | -31                | -34   | 32        | 19     | 4540                   | 23               | 92                     | 250           | 0.3          | 325                | 220                             | 1.1                  | 0.1            | 0.38                       | 0.48 |
| Peace River           | 330      | -37                | -40   | 27        | 18     | 6050                   | 15               | 81                     | 300           | 0.5          | 390                | 100                             | 2.2                  | 0.1            | 0.24                       | 0.32 |
| Pincher Creek         | 1130     | -29                | -32   | 29        | 18     | 4740                   | 16               | 103                    | 325           | 0.4          | 575                | 140                             | 1.5                  | 0.1            | 0.77                       | 0.96 |
| Ranfurly              | 670      | -34                | -37   | 29        | 19     | 5700                   | 18               | 92                     | 325           | 0.5          | 420                | 100                             | 1.9                  | 0.1            | 0.29                       | 0.36 |
| Red Deer              | 855      | -32                | -35   | 28        | 19     | 5550                   | 20               | 97                     | 375           | 0.5          | 475                | 200                             | 1.8                  | 0.1            | 0.32                       | 0.40 |
| Rocky Mountain House  | 985      | -32                | -34   | 27        | 18     | 5640                   | 20               | 92                     | 425           | 0.6          | 550                | 120                             | 1.9                  | 0.1            | 0.29                       | 0.36 |
| Slave Lake            | 590      | -35                | -38   | 26        | 19     | 5850                   | 15               | 81                     | 380           | 0.6          | 500                | 80                              | 1.9                  | 0.1            | 0.28                       | 0.37 |
| Stettler              | 820      | -32                | -34   | 30        | 19     | 5300                   | 20               | 97                     | 370           | 0.5          | 450                | 200                             | 1.9                  | 0.1            | 0.29                       | 0.36 |
| Stony Plain           | 710      | -32                | -35   | 28        | 19     | 5300                   | 23               | 97                     | 410           | 0.5          | 540                | 120                             | 1.7                  | 0.1            | 0.36                       | 0.45 |
| Suffield              | 755      | -31                | -34   | 32        | 20     | 4770                   | 20               | 86                     | 230           | 0.2          | 325                | 220                             | 1.3                  | 0.1            | 0.39                       | 0.49 |
| Taber                 | 815      | -31                | -33   | 31        | 19     | 4580                   | 20               | 92                     | 260           | 0.3          | 370                | 200                             | 1.2                  | 0.1            | 0.50                       | 0.63 |
| Turner Valley         | 1215     | -31                | -32   | 28        | 17     | 5220                   | 20               | 97                     | 350           | 0.5          | 600                | 180                             | 1.4                  | 0.1            | 0.52                       | 0.65 |
| Valleyview            | 700      | -37                | -40   | 27        | 18     | 5600                   | 18               | 86                     | 360           | 0.5          | 490                | 80                              | 2.3                  | 0.1            | 0.34                       | 0.42 |
| Vegreville            | 635      | -34                | -37   | 29        | 19     | 5780                   | 18               | 86                     | 325           | 0.5          | 410                | 100                             | 1.9                  | 0.1            | 0.29                       | 0.36 |

Table C-2 (Continued)

| Province and Location | Elev., m | Design Temperature |       |           |        | Degree-Days Below 18°C | 15 Min. Rain, mm | One Day Rain, 1/50, mm | Ann. Rain, mm | Moist. Index | Ann. Tot. Ppn., mm | Driving Wind Pressures, Pa, 1/5 | Snow Load, kPa, 1/50 |                | Hourly Wind Pressures, kPa |      |
|-----------------------|----------|--------------------|-------|-----------|--------|------------------------|------------------|------------------------|---------------|--------------|--------------------|---------------------------------|----------------------|----------------|----------------------------|------|
|                       |          | January            |       | July 2.5% |        |                        |                  |                        |               |              |                    |                                 | S <sub>s</sub>       | S <sub>r</sub> | 1/10                       | 1/50 |
|                       |          | 2.5% °C            | 1% °C | Dry °C    | Wet °C |                        |                  |                        |               |              |                    |                                 |                      |                |                            |      |
| Vermilion             | 580      | -35                | -38   | 29        | 19     | 5740                   | 18               | 86                     | 310           | 0.5          | 410                | 100                             | 1.7                  | 0.1            | 0.29                       | 0.36 |
| Wagner                | 585      | -35                | -38   | 26        | 19     | 5850                   | 15               | 81                     | 380           | 0.6          | 500                | 80                              | 1.9                  | 0.1            | 0.28                       | 0.37 |
| Wainwright            | 675      | -33                | -36   | 29        | 19     | 5700                   | 20               | 81                     | 310           | 0.5          | 425                | 120                             | 2.0                  | 0.1            | 0.29                       | 0.36 |
| Weiskiwini            | 760      | -33                | -35   | 29        | 19     | 5500                   | 23               | 86                     | 400           | 0.6          | 500                | 160                             | 2.0                  | 0.1            | 0.31                       | 0.39 |
| Whitecourt            | 690      | -33                | -36   | 27        | 19     | 5650                   | 20               | 97                     | 440           | 0.6          | 550                | 80                              | 1.9                  | 0.1            | 0.28                       | 0.37 |
| Wimborne              | 975      | -31                | -34   | 29        | 18     | 5310                   | 23               | 92                     | 325           | 0.5          | 450                | 200                             | 1.6                  | 0.1            | 0.32                       | 0.40 |
| <b>Saskatchewan</b>   |          |                    |       |           |        |                        |                  |                        |               |              |                    |                                 |                      |                |                            |      |
| Assiniboia            | 740      | -32                | -34   | 31        | 21     | 5180                   | 25               | 81                     | 290           | 0.3          | 375                | 240                             | 1.6                  | 0.1            | 0.39                       | 0.49 |
| Batroum               | 700      | -32                | -34   | 32        | 20     | 5080                   | 23               | 81                     | 270           | 0.4          | 350                | 260                             | 1.2                  | 0.1            | 0.43                       | 0.54 |
| Biggar                | 645      | -34                | -36   | 30        | 20     | 5720                   | 23               | 81                     | 270           | 0.4          | 350                | 180                             | 2.1                  | 0.1            | 0.36                       | 0.45 |
| Broadview             | 600      | -34                | -35   | 30        | 21     | 5760                   | 25               | 103                    | 320           | 0.5          | 420                | 160                             | 1.7                  | 0.1            | 0.36                       | 0.46 |
| Datoc                 | 530      | -35                | -37   | 29        | 21     | 5860                   | 20               | 92                     | 300           | 0.5          | 380                | 140                             | 1.7                  | 0.1            | 0.29                       | 0.37 |
| Dundurn               | 525      | -35                | -37   | 30        | 21     | 5600                   | 23               | 86                     | 275           | 0.4          | 380                | 180                             | 1.5                  | 0.1            | 0.36                       | 0.46 |
| Estevan               | 565      | -32                | -34   | 32        | 22     | 5340                   | 28               | 92                     | 330           | 0.4          | 420                | 200                             | 1.6                  | 0.1            | 0.41                       | 0.52 |
| Hudson Bay            | 370      | -36                | -38   | 29        | 21     | 6280                   | 20               | 81                     | 340           | 0.6          | 450                | 80                              | 2.0                  | 0.1            | 0.29                       | 0.37 |
| Humboldt              | 565      | -36                | -38   | 28        | 21     | 6000                   | 20               | 86                     | 320           | 0.5          | 375                | 140                             | 2.1                  | 0.1            | 0.31                       | 0.39 |
| Island Falls          | 305      | -39                | -41   | 27        | 20     | 7100                   | 18               | 76                     | 370           | 0.6          | 510                | 80                              | 2.1                  | 0.1            | 0.26                       | 0.35 |
| Kamsack               | 455      | -34                | -37   | 29        | 22     | 6040                   | 20               | 97                     | 360           | 0.6          | 450                | 120                             | 2.1                  | 0.2            | 0.32                       | 0.40 |
| Kindersley            | 685      | -33                | -35   | 31        | 20     | 5550                   | 23               | 81                     | 260           | 0.4          | 325                | 200                             | 1.4                  | 0.1            | 0.36                       | 0.46 |
| Lloydminster          | 645      | -34                | -37   | 28        | 20     | 5880                   | 18               | 81                     | 310           | 0.5          | 430                | 120                             | 2.0                  | 0.1            | 0.32                       | 0.40 |
| Maple Creek           | 765      | -31                | -34   | 31        | 20     | 4780                   | 25               | 81                     | 275           | 0.3          | 380                | 220                             | 1.2                  | 0.1            | 0.36                       | 0.45 |
| Meadow Lake           | 480      | -38                | -40   | 28        | 20     | 6280                   | 18               | 81                     | 320           | 0.5          | 450                | 120                             | 1.7                  | 0.1            | 0.30                       | 0.40 |
| Melfort               | 455      | -36                | -38   | 28        | 21     | 6050                   | 20               | 81                     | 310           | 0.5          | 410                | 120                             | 2.1                  | 0.1            | 0.28                       | 0.36 |
| Melville              | 550      | -34                | -36   | 29        | 21     | 5880                   | 23               | 97                     | 340           | 0.5          | 410                | 160                             | 1.7                  | 0.1            | 0.32                       | 0.40 |
| Moose Jaw             | 545      | -32                | -34   | 31        | 21     | 5270                   | 25               | 86                     | 270           | 0.3          | 360                | 200                             | 1.4                  | 0.1            | 0.41                       | 0.52 |
| Nipawin               | 365      | -37                | -39   | 28        | 21     | 6300                   | 20               | 76                     | 340           | 0.6          | 450                | 100                             | 2.0                  | 0.1            | 0.30                       | 0.38 |
| North Battleford      | 545      | -34                | -36   | 29        | 20     | 5900                   | 20               | 81                     | 280           | 0.5          | 370                | 120                             | 1.7                  | 0.1            | 0.36                       | 0.46 |
| Prince Albert         | 435      | -37                | -40   | 28        | 21     | 6100                   | 20               | 81                     | 320           | 0.5          | 410                | 140                             | 1.9                  | 0.1            | 0.30                       | 0.38 |

Table C-2 (Continued)

Table C-2 (Continued)

| Province and Location | Elev., m | Design Temperature |       |           |        | Degree-Days Below 18°C | 15 Min. Rain, mm | One Day Rain, 1/50, mm | Ann. Rain, mm | Moist. Index | Ann. Tot. Ppn., mm | Driving Rain Wind Pressures, Pa, 1/5 | Snow Load, kPa, 1/50 |                | Hourly Wind Pressures, kPa |      |
|-----------------------|----------|--------------------|-------|-----------|--------|------------------------|------------------|------------------------|---------------|--------------|--------------------|--------------------------------------|----------------------|----------------|----------------------------|------|
|                       |          | January            |       | July 2.5% |        |                        |                  |                        |               |              |                    |                                      | S <sub>s</sub>       | S <sub>t</sub> | 1/10                       | 1/50 |
|                       |          | 2.5% °C            | 1% °C | Dry °C    | Wet °C |                        |                  |                        |               |              |                    |                                      |                      |                |                            |      |
| Qu'Appelle            | 645      | -34                | -36   | 30        | 22     | 5620                   | 25               | 97                     | 340           | 0.5          | 430                | 160                                  | 1.7                  | 0.1            | 0.33                       | 0.42 |
| Regina                | 575      | -34                | -36   | 31        | 21     | 5600                   | 28               | 103                    | 300           | 0.4          | 365                | 200                                  | 1.4                  | 0.1            | 0.39                       | 0.49 |
| Rosetown              | 595      | -34                | -36   | 31        | 20     | 5620                   | 23               | 81                     | 260           | 0.4          | 330                | 200                                  | 1.7                  | 0.1            | 0.39                       | 0.49 |
| Saskatoon             | 500      | -35                | -37   | 30        | 21     | 5700                   | 23               | 86                     | 265           | 0.4          | 350                | 160                                  | 1.7                  | 0.1            | 0.36                       | 0.46 |
| Scott                 | 645      | -34                | -36   | 30        | 20     | 5960                   | 20               | 81                     | 270           | 0.4          | 360                | 140                                  | 1.9                  | 0.1            | 0.36                       | 0.45 |
| Strasbourg            | 545      | -34                | -36   | 30        | 22     | 5600                   | 25               | 92                     | 300           | 0.4          | 390                | 180                                  | 1.5                  | 0.1            | 0.33                       | 0.42 |
| Swift Current         | 750      | -31                | -34   | 31        | 20     | 5150                   | 25               | 81                     | 260           | 0.3          | 350                | 240                                  | 1.4                  | 0.1            | 0.43                       | 0.54 |
| Uranium City          | 265      | -42                | -44   | 26        | 19     | 7500                   | 12               | 54                     | 300           | 0.6          | 360                | 100                                  | 2.0                  | 0.1            | 0.27                       | 0.36 |
| Weyburn               | 575      | -33                | -35   | 31        | 23     | 5400                   | 28               | 97                     | 320           | 0.4          | 400                | 200                                  | 1.8                  | 0.1            | 0.38                       | 0.48 |
| Yorkton               | 510      | -34                | -37   | 29        | 21     | 6000                   | 23               | 97                     | 350           | 0.5          | 440                | 140                                  | 1.9                  | 0.1            | 0.32                       | 0.40 |
| <b>Manitoba</b>       |          |                    |       |           |        |                        |                  |                        |               |              |                    |                                      |                      |                |                            |      |
| Beausejour            | 245      | -33                | -35   | 29        | 23     | 5680                   | 28               | 103                    | 430           | 0.6          | 530                | 180                                  | 2.0                  | 0.2            | 0.32                       | 0.41 |
| Boissevain            | 510      | -32                | -34   | 30        | 23     | 5500                   | 28               | 119                    | 390           | 0.5          | 510                | 180                                  | 2.2                  | 0.2            | 0.41                       | 0.52 |
| Brandon               | 395      | -33                | -35   | 30        | 22     | 5760                   | 28               | 108                    | 375           | 0.6          | 460                | 180                                  | 2.1                  | 0.2            | 0.39                       | 0.49 |
| Churchill             | 10       | -38                | -40   | 25        | 18     | 8950                   | 12               | 76                     | 265           | 0.8          | 410                | 260                                  | 3.0                  | 0.2            | 0.43                       | 0.55 |
| Dauphin               | 295      | -33                | -35   | 30        | 22     | 5900                   | 28               | 103                    | 400           | 0.6          | 490                | 160                                  | 1.9                  | 0.2            | 0.32                       | 0.40 |
| Flin Flon             | 300      | -38                | -40   | 27        | 20     | 6440                   | 18               | 81                     | 340           | 0.6          | 475                | 80                                   | 2.2                  | 0.2            | 0.28                       | 0.35 |
| Gimli                 | 220      | -34                | -36   | 29        | 23     | 5800                   | 28               | 108                    | 410           | 0.7          | 530                | 180                                  | 1.9                  | 0.2            | 0.32                       | 0.40 |
| Island Lake           | 240      | -36                | -38   | 27        | 20     | 6900                   | 18               | 86                     | 380           | 0.7          | 550                | 80                                   | 2.6                  | 0.2            | 0.29                       | 0.37 |
| Lac du Bonnet         | 260      | -34                | -36   | 29        | 23     | 5730                   | 28               | 103                    | 445           | 0.7          | 560                | 180                                  | 1.9                  | 0.2            | 0.29                       | 0.37 |
| Lynn Lake             | 350      | -40                | -42   | 27        | 19     | 7770                   | 18               | 86                     | 310           | 0.6          | 490                | 100                                  | 2.4                  | 0.2            | 0.29                       | 0.37 |
| Morden                | 300      | -31                | -33   | 30        | 24     | 5400                   | 28               | 119                    | 420           | 0.6          | 520                | 180                                  | 2.2                  | 0.2            | 0.41                       | 0.52 |
| Neepawa               | 365      | -32                | -34   | 29        | 23     | 5760                   | 28               | 108                    | 410           | 0.6          | 470                | 180                                  | 2.2                  | 0.2            | 0.35                       | 0.44 |
| Pine Falls            | 220      | -34                | -36   | 28        | 23     | 5900                   | 25               | 97                     | 440           | 0.7          | 420                | 180                                  | 1.9                  | 0.2            | 0.31                       | 0.39 |
| Portage la Prairie    | 260      | -31                | -33   | 30        | 23     | 5600                   | 28               | 108                    | 390           | 0.5          | 525                | 180                                  | 2.1                  | 0.2            | 0.36                       | 0.46 |
| Rivers                | 465      | -34                | -36   | 29        | 23     | 5840                   | 28               | 108                    | 370           | 0.6          | 460                | 180                                  | 2.1                  | 0.2            | 0.36                       | 0.46 |
| Sandilands            | 365      | -32                | -34   | 29        | 23     | 5650                   | 28               | 113                    | 460           | 0.6          | 550                | 180                                  | 2.2                  | 0.2            | 0.32                       | 0.40 |
| Selkirk               | 225      | -33                | -35   | 29        | 23     | 5700                   | 28               | 108                    | 420           | 0.6          | 500                | 180                                  | 1.9                  | 0.2            | 0.32                       | 0.41 |

Table C-2 (Continued)

Table C-2 (Continued)

| Province and Location | Elev., m | Design Temperature |       |           |        | Degree-Days Below 18°C | 15 Min. Rain, mm | One Day Rain, 1/50, mm | Ann. Rain, mm | Moist. Index | Ann. Tot. Ppn., mm | Driving Wind Pressures, Pa, 1/5 | Snow Load, kPa, 1/50 |                | Hourly Wind Pressures, kPa |      |
|-----------------------|----------|--------------------|-------|-----------|--------|------------------------|------------------|------------------------|---------------|--------------|--------------------|---------------------------------|----------------------|----------------|----------------------------|------|
|                       |          | January            |       | July 2.5% |        |                        |                  |                        |               |              |                    |                                 | S <sub>s</sub>       | S <sub>r</sub> | 1/10                       | 1/50 |
|                       |          | 2.5% °C            | 1% °C | Dry °C    | Wet °C |                        |                  |                        |               |              |                    |                                 |                      |                |                            |      |
| Split Lake            | 175      | -38                | -40   | 27        | 19     | 7900                   | 18               | 76                     | 325           | 0.7          | 500                | 120                             | 2.5                  | 0.2            | 0.31                       | 0.39 |
| Steinbach             | 270      | -33                | -35   | 29        | 23     | 5700                   | 28               | 108                    | 440           | 0.6          | 500                | 180                             | 2.0                  | 0.2            | 0.32                       | 0.40 |
| Swan River            | 335      | -34                | -37   | 29        | 22     | 6100                   | 20               | 92                     | 370           | 0.6          | 500                | 120                             | 2.0                  | 0.2            | 0.28                       | 0.35 |
| The Pas               | 270      | -36                | -38   | 28        | 21     | 6480                   | 18               | 81                     | 330           | 0.6          | 450                | 160                             | 2.2                  | 0.2            | 0.29                       | 0.37 |
| Thompson              | 205      | -40                | -43   | 27        | 19     | 7600                   | 18               | 86                     | 350           | 0.6          | 540                | 100                             | 2.4                  | 0.2            | 0.28                       | 0.36 |
| Virten                | 435      | -33                | -35   | 30        | 23     | 5620                   | 28               | 108                    | 350           | 0.5          | 460                | 180                             | 2.0                  | 0.2            | 0.36                       | 0.46 |
| Winnipeg              | 235      | -33                | -35   | 30        | 23     | 5670                   | 28               | 108                    | 415           | 0.6          | 500                | 180                             | 1.9                  | 0.2            | 0.36                       | 0.45 |
| <b>Ontario</b>        |          |                    |       |           |        |                        |                  |                        |               |              |                    |                                 |                      |                |                            |      |
| Alisa Craig           | 230      | -17                | -19   | 30        | 23     | 3840                   | 25               | 103                    | 800           | 0.9          | 950                | 180                             | 2.2                  | 0.4            | 0.37                       | 0.48 |
| Ajax                  | 95       | -20                | -22   | 30        | 23     | 3820                   | 23               | 92                     | 760           | 0.9          | 825                | 160                             | 1.0                  | 0.4            | 0.37                       | 0.48 |
| Alexandria            | 80       | -24                | -26   | 30        | 23     | 4600                   | 25               | 103                    | 800           | 0.9          | 975                | 160                             | 2.4                  | 0.4            | 0.31                       | 0.40 |
| Alliston              | 220      | -23                | -25   | 29        | 23     | 4200                   | 28               | 113                    | 690           | 0.8          | 875                | 120                             | 2.0                  | 0.4            | 0.28                       | 0.36 |
| Almonte               | 120      | -26                | -28   | 30        | 23     | 4620                   | 25               | 97                     | 730           | 0.8          | 800                | 140                             | 2.5                  | 0.4            | 0.32                       | 0.41 |
| Armstrong             | 340      | -37                | -40   | 28        | 21     | 6500                   | 23               | 97                     | 525           | 0.8          | 725                | 100                             | 2.7                  | 0.4            | 0.22                       | 0.30 |
| Arnprior              | 85       | -27                | -29   | 30        | 23     | 4680                   | 23               | 86                     | 630           | 0.8          | 775                | 140                             | 2.5                  | 0.4            | 0.29                       | 0.37 |
| Atikokan              | 400      | -33                | -35   | 29        | 22     | 5750                   | 25               | 103                    | 570           | 0.8          | 760                | 100                             | 2.4                  | 0.3            | 0.22                       | 0.30 |
| Attawapiskat          | 10       | -37                | -39   | 28        | 21     | 7100                   | 18               | 81                     | 450           | 0.8          | 650                | 160                             | 2.8                  | 0.3            | 0.30                       | 0.41 |
| Aurora                | 270      | -21                | -23   | 30        | 23     | 4210                   | 28               | 108                    | 700           | 0.8          | 800                | 140                             | 2.0                  | 0.4            | 0.34                       | 0.44 |
| Bancroft              | 365      | -28                | -31   | 29        | 23     | 4740                   | 25               | 92                     | 720           | 0.9          | 900                | 100                             | 3.1                  | 0.4            | 0.25                       | 0.32 |
| Barrie                | 245      | -24                | -26   | 29        | 23     | 4380                   | 28               | 97                     | 700           | 0.8          | 900                | 120                             | 2.5                  | 0.4            | 0.28                       | 0.36 |
| Barrie/field          | 100      | -22                | -24   | 28        | 23     | 3990                   | 23               | 108                    | 780           | 1.0          | 950                | 160                             | 2.1                  | 0.4            | 0.37                       | 0.47 |
| Beaverton             | 240      | -24                | -26   | 30        | 23     | 4300                   | 25               | 108                    | 720           | 0.9          | 950                | 120                             | 2.2                  | 0.4            | 0.28                       | 0.36 |
| Belleville            | 90       | -22                | -24   | 29        | 23     | 3910                   | 23               | 97                     | 760           | 0.9          | 850                | 180                             | 1.7                  | 0.4            | 0.34                       | 0.43 |
| Belmont               | 260      | -17                | -19   | 30        | 24     | 3840                   | 25               | 97                     | 850           | 1.0          | 950                | 180                             | 1.7                  | 0.4            | 0.37                       | 0.47 |
| Borden (CFB)          | 225      | -23                | -25   | 29        | 23     | 4300                   | 28               | 103                    | 690           | 0.82         | 875                | 120                             | 2.2                  | 0.4            | 0.28                       | 0.36 |
| Bracebridge           | 310      | -26                | -28   | 29        | 23     | 4800                   | 25               | 103                    | 830           | 1.0          | 1050               | 120                             | 3.1                  | 0.4            | 0.27                       | 0.35 |
| Bradford              | 240      | -23                | -25   | 30        | 23     | 4280                   | 28               | 108                    | 680           | 0.8          | 800                | 120                             | 2.1                  | 0.4            | 0.28                       | 0.36 |
| Brampton              | 215      | -19                | -21   | 30        | 23     | 4100                   | 28               | 119                    | 720           | 0.8          | 820                | 140                             | 1.3                  | 0.4            | 0.34                       | 0.44 |

Table C-2 (Continued)

Table C-2 (Continued)

| Province and Location | Elev., m | Design Temperature |       |           |        | Degree-Days Below 18°C | 15 Min. Rain, mm | One Day Rain, 1/50, mm | Ann. Rain, mm | Moist. Index | Ann. Tot. Ppn., mm | Driving Rain Wind Pressures, Pa, 1/5 | Snow Load, kPa, 1/50 |                | Hourly Wind Pressures, kPa |      |
|-----------------------|----------|--------------------|-------|-----------|--------|------------------------|------------------|------------------------|---------------|--------------|--------------------|--------------------------------------|----------------------|----------------|----------------------------|------|
|                       |          | January            |       | July 2.5% |        |                        |                  |                        |               |              |                    |                                      | S <sub>s</sub>       | S <sub>t</sub> | 1/10                       | 1/50 |
|                       |          | 2.5% °C            | 1% °C | Dry °C    | Wet °C |                        |                  |                        |               |              |                    |                                      |                      |                |                            |      |
| Brantford             | 205      | -18                | -20   | 30        | 23     | 3900                   | 23               | 103                    | 780           | 0.9          | 850                | 160                                  | 1.3                  | 0.4            | 0.33                       | 0.42 |
| Brighton              | 95       | -21                | -23   | 29        | 23     | 4000                   | 23               | 94                     | 760           | 0.9          | 850                | 160                                  | 1.6                  | 0.4            | 0.37                       | 0.48 |
| Brockville            | 85       | -23                | -25   | 29        | 23     | 4060                   | 25               | 103                    | 770           | 0.9          | 975                | 180                                  | 2.2                  | 0.4            | 0.34                       | 0.44 |
| Burk's Falls          | 305      | -26                | -28   | 29        | 22     | 5020                   | 25               | 97                     | 810           | 0.9          | 1010               | 120                                  | 2.7                  | 0.4            | 0.27                       | 0.35 |
| Burlington            | 80       | -17                | -19   | 31        | 23     | 3740                   | 23               | 103                    | 770           | 0.9          | 850                | 160                                  | 1.1                  | 0.4            | 0.36                       | 0.46 |
| Cambridge             | 295      | -18                | -20   | 29        | 23     | 4100                   | 25               | 113                    | 800           | 0.9          | 890                | 160                                  | 1.6                  | 0.4            | 0.28                       | 0.36 |
| Campbellford          | 150      | -23                | -26   | 30        | 23     | 4280                   | 25               | 97                     | 730           | 0.9          | 850                | 160                                  | 1.7                  | 0.4            | 0.32                       | 0.41 |
| Cannington            | 255      | -24                | -26   | 30        | 23     | 4310                   | 25               | 108                    | 740           | 0.9          | 950                | 120                                  | 2.2                  | 0.4            | 0.28                       | 0.36 |
| Carleton Place        | 135      | -25                | -27   | 30        | 23     | 4600                   | 25               | 97                     | 730           | 0.8          | 850                | 160                                  | 2.5                  | 0.4            | 0.32                       | 0.41 |
| Cavan                 | 200      | -23                | -25   | 30        | 23     | 4400                   | 25               | 97                     | 740           | 0.9          | 850                | 140                                  | 2.0                  | 0.4            | 0.34                       | 0.44 |
| Centralia             | 260      | -17                | -19   | 30        | 23     | 3800                   | 25               | 103                    | 820           | 1.0          | 1000               | 180                                  | 2.3                  | 0.4            | 0.37                       | 0.48 |
| Chapleau              | 425      | -35                | -38   | 27        | 21     | 5900                   | 20               | 97                     | 530           | 0.7          | 850                | 80                                   | 3.6                  | 0.4            | 0.23                       | 0.30 |
| Chatham               | 180      | -16                | -18   | 31        | 24     | 3470                   | 28               | 103                    | 800           | 0.9          | 850                | 180                                  | 1.0                  | 0.4            | 0.34                       | 0.43 |
| Chesley               | 275      | -19                | -21   | 29        | 22     | 4320                   | 28               | 103                    | 810           | 0.9          | 1125               | 140                                  | 2.8                  | 0.4            | 0.35                       | 0.45 |
| Clinton               | 280      | -17                | -19   | 29        | 23     | 4150                   | 25               | 103                    | 810           | 0.9          | 1000               | 160                                  | 2.6                  | 0.4            | 0.36                       | 0.46 |
| Coboconk              | 270      | -25                | -27   | 30        | 23     | 4500                   | 25               | 108                    | 740           | 0.9          | 950                | 120                                  | 2.5                  | 0.4            | 0.27                       | 0.35 |
| Cobourg               | 90       | -21                | -23   | 29        | 23     | 3980                   | 23               | 94                     | 760           | 0.9          | 825                | 160                                  | 1.2                  | 0.4            | 0.38                       | 0.49 |
| Cochrane              | 245      | -34                | -36   | 29        | 21     | 6200                   | 20               | 92                     | 575           | 0.8          | 875                | 80                                   | 2.8                  | 0.3            | 0.27                       | 0.35 |
| Colborne              | 105      | -21                | -23   | 29        | 23     | 3980                   | 23               | 94                     | 760           | 0.9          | 850                | 160                                  | 1.6                  | 0.4            | 0.38                       | 0.49 |
| Collingwood           | 190      | -21                | -23   | 29        | 23     | 4180                   | 28               | 97                     | 720           | 0.9          | 950                | 160                                  | 2.7                  | 0.4            | 0.30                       | 0.39 |
| Cornwall              | 35       | -23                | -25   | 30        | 23     | 4250                   | 25               | 103                    | 780           | 0.9          | 960                | 180                                  | 2.2                  | 0.4            | 0.32                       | 0.41 |
| Corunna               | 185      | -16                | -18   | 31        | 24     | 3600                   | 25               | 100                    | 760           | 0.9          | 800                | 180                                  | 1.0                  | 0.4            | 0.37                       | 0.47 |
| Deep River            | 145      | -29                | -32   | 30        | 22     | 4900                   | 23               | 92                     | 650           | 0.8          | 850                | 100                                  | 2.5                  | 0.4            | 0.27                       | 0.35 |
| Deseronto             | 85       | -22                | -24   | 29        | 23     | 4070                   | 23               | 92                     | 760           | 0.9          | 900                | 160                                  | 1.9                  | 0.4            | 0.34                       | 0.43 |
| Dorchester            | 260      | -18                | -20   | 30        | 24     | 3900                   | 28               | 103                    | 850           | 1.0          | 950                | 180                                  | 1.9                  | 0.4            | 0.37                       | 0.47 |
| Dorion                | 200      | -33                | -35   | 28        | 21     | 5950                   | 20               | 103                    | 550           | 0.8          | 725                | 160                                  | 2.8                  | 0.4            | 0.29                       | 0.39 |
| Dresden               | 185      | -16                | -18   | 31        | 24     | 3750                   | 28               | 97                     | 760           | 0.8          | 820                | 180                                  | 1.0                  | 0.4            | 0.34                       | 0.43 |
| Dryden                | 370      | -34                | -36   | 28        | 22     | 5850                   | 25               | 97                     | 550           | 0.7          | 700                | 120                                  | 2.4                  | 0.3            | 0.22                       | 0.30 |

Table C-2 (Continued)

| Province and Location         | Elev., m | Design Temperature |       |           |        | Degree-Days Below 18°C | 15 Min. Rain, mm | One Day Rain, 1/50, mm | Ann. Rain, mm | Moist. Index | Ann. Tot. Ppn., mm | Driving Wind Pressures, Pa, 1/5 | Snow Load, kPa, 1/50 |                | Hourly Wind Pressures, kPa |      |
|-------------------------------|----------|--------------------|-------|-----------|--------|------------------------|------------------|------------------------|---------------|--------------|--------------------|---------------------------------|----------------------|----------------|----------------------------|------|
|                               |          | January            |       | July 2.5% |        |                        |                  |                        |               |              |                    |                                 | S <sub>s</sub>       | S <sub>r</sub> | 1/10                       | 1/50 |
|                               |          | 2.5% °C            | 1% °C | Dry °C    | Wet °C |                        |                  |                        |               |              |                    |                                 |                      |                |                            |      |
| Dundalk                       | 525      | -22                | -24   | 29        | 22     | 4700                   | 28               | 108                    | 750           | 0.9          | 1080               | 150                             | 3.2                  | 0.4            | 0.33                       | 0.42 |
| Dunnville                     | 175      | -15                | -17   | 30        | 24     | 3660                   | 23               | 108                    | 830           | 1.0          | 950                | 160                             | 2.0                  | 0.4            | 0.36                       | 0.46 |
| Durham                        | 340      | -20                | -22   | 29        | 22     | 4340                   | 28               | 103                    | 815           | 0.9          | 1025               | 140                             | 2.8                  | 0.4            | 0.34                       | 0.44 |
| Dutton                        | 225      | -16                | -18   | 31        | 24     | 3700                   | 28               | 92                     | 850           | 1.0          | 925                | 180                             | 1.3                  | 0.4            | 0.37                       | 0.47 |
| Earlton                       | 245      | -33                | -36   | 29        | 22     | 5730                   | 23               | 92                     | 560           | 0.8          | 820                | 120                             | 3.1                  | 0.4            | 0.35                       | 0.45 |
| Edison                        | 365      | -34                | -36   | 28        | 22     | 5740                   | 25               | 108                    | 510           | 0.7          | 680                | 120                             | 2.4                  | 0.3            | 0.23                       | 0.31 |
| Elliot Lake                   | 380      | -26                | -28   | 29        | 21     | 4950                   | 23               | 108                    | 630           | 0.8          | 950                | 160                             | 2.9                  | 0.4            | 0.30                       | 0.38 |
| Elmvale                       | 220      | -24                | -26   | 29        | 23     | 4200                   | 28               | 97                     | 720           | 0.9          | 950                | 140                             | 2.6                  | 0.4            | 0.28                       | 0.36 |
| Embro                         | 310      | -19                | -21   | 30        | 23     | 3950                   | 28               | 113                    | 830           | 0.9          | 950                | 160                             | 2.0                  | 0.4            | 0.37                       | 0.48 |
| Englehart                     | 205      | -33                | -36   | 29        | 22     | 5800                   | 23               | 92                     | 600           | 0.8          | 880                | 100                             | 2.8                  | 0.4            | 0.32                       | 0.41 |
| Espanola                      | 220      | -25                | -27   | 29        | 21     | 4920                   | 23               | 108                    | 650           | 0.8          | 840                | 160                             | 2.3                  | 0.4            | 0.33                       | 0.42 |
| Exeter                        | 265      | -17                | -19   | 30        | 23     | 3900                   | 25               | 113                    | 810           | 0.9          | 975                | 180                             | 2.4                  | 0.4            | 0.37                       | 0.48 |
| Fenelon Falls                 | 260      | -25                | -27   | 30        | 23     | 4440                   | 25               | 108                    | 730           | 0.9          | 950                | 120                             | 2.3                  | 0.4            | 0.28                       | 0.36 |
| Fergus                        | 400      | -20                | -22   | 29        | 23     | 4300                   | 28               | 108                    | 760           | 0.9          | 925                | 160                             | 2.2                  | 0.4            | 0.28                       | 0.36 |
| Forest                        | 215      | -16                | -18   | 31        | 23     | 3740                   | 25               | 103                    | 810           | 1.0          | 875                | 160                             | 2.0                  | 0.4            | 0.37                       | 0.48 |
| Fort Erie                     | 180      | -15                | -17   | 30        | 24     | 3650                   | 23               | 108                    | 860           | 1.0          | 1020               | 160                             | 2.3                  | 0.4            | 0.36                       | 0.46 |
| Fort Erie (Ridgeway)          | 190      | -15                | -17   | 30        | 24     | 3600                   | 25               | 108                    | 860           | 1.0          | 1000               | 160                             | 2.3                  | 0.4            | 0.36                       | 0.46 |
| Fort Frances                  | 340      | -33                | -35   | 29        | 22     | 5440                   | 25               | 108                    | 570           | 0.7          | 725                | 120                             | 2.3                  | 0.3            | 0.23                       | 0.31 |
| Gananoque                     | 80       | -22                | -24   | 28        | 23     | 4010                   | 23               | 103                    | 760           | 0.9          | 900                | 180                             | 2.1                  | 0.4            | 0.37                       | 0.47 |
| Geraldton                     | 345      | -36                | -39   | 28        | 21     | 6450                   | 20               | 86                     | 550           | 0.8          | 725                | 100                             | 2.9                  | 0.4            | 0.22                       | 0.30 |
| Glencoe                       | 215      | -16                | -18   | 31        | 24     | 3680                   | 28               | 103                    | 800           | 0.9          | 925                | 180                             | 1.5                  | 0.4            | 0.34                       | 0.43 |
| Goderich                      | 185      | -16                | -18   | 29        | 23     | 4000                   | 25               | 92                     | 810           | 1.0          | 950                | 180                             | 2.4                  | 0.4            | 0.37                       | 0.48 |
| Gore Bay                      | 205      | -24                | -26   | 28        | 22     | 4700                   | 23               | 92                     | 640           | 0.8          | 860                | 160                             | 2.6                  | 0.4            | 0.34                       | 0.44 |
| Graham                        | 495      | -35                | -37   | 29        | 22     | 5940                   | 23               | 97                     | 570           | 0.8          | 750                | 140                             | 2.6                  | 0.3            | 0.22                       | 0.30 |
| Gravenhurst (Muskoka Airport) | 255      | -26                | -28   | 29        | 23     | 4760                   | 25               | 103                    | 790           | 0.9          | 1050               | 120                             | 2.7                  | 0.4            | 0.28                       | 0.36 |
| Grimsby                       | 85       | -16                | -18   | 30        | 23     | 3520                   | 23               | 108                    | 760           | 0.9          | 875                | 160                             | 0.9                  | 0.4            | 0.36                       | 0.46 |
| Guelph                        | 340      | -19                | -21   | 29        | 23     | 4270                   | 28               | 103                    | 770           | 0.9          | 875                | 140                             | 1.9                  | 0.4            | 0.28                       | 0.36 |

Table C-2 (Continued)

Table C-2 (Continued)

| Province and Location     | Elev., m | Design Temperature |       |           |        | Degree-Days Below 18°C | 15 Min. Rain, mm | One Day Rain, 1/50, mm | Ann. Rain, mm | Moist. Index | Ann. Tot. Ppn., mm | Driving Rain Wind Pressures, Pa, 1/5 | Snow Load, kPa, 1/50 |                | Hourly Wind Pressures, kPa |      |
|---------------------------|----------|--------------------|-------|-----------|--------|------------------------|------------------|------------------------|---------------|--------------|--------------------|--------------------------------------|----------------------|----------------|----------------------------|------|
|                           |          | January            |       | July 2.5% |        |                        |                  |                        |               |              |                    |                                      | S <sub>s</sub>       | S <sub>r</sub> | 1/10                       | 1/50 |
|                           |          | 2.5% °C            | 1% °C | Dry °C    | Wet °C |                        |                  |                        |               |              |                    |                                      |                      |                |                            |      |
| Guthrie                   | 280      | -24                | -26   | 29        | 23     | 4300                   | 28               | 103                    | 700           | 0.8          | 950                | 120                                  | 2.5                  | 0.4            | 0.28                       | 0.36 |
| Halleybury                | 210      | -32                | -35   | 30        | 22     | 5600                   | 23               | 92                     | 590           | 0.8          | 820                | 120                                  | 2.4                  | 0.4            | 0.34                       | 0.44 |
| Haldimand (Caledonia)     | 190      | -18                | -20   | 30        | 23     | 3750                   | 23               | 108                    | 810           | 0.9          | 875                | 160                                  | 1.2                  | 0.4            | 0.34                       | 0.44 |
| Haldimand (Hagersville)   | 215      | -17                | -19   | 30        | 23     | 3760                   | 25               | 97                     | 840           | 1.0          | 875                | 160                                  | 1.3                  | 0.4            | 0.36                       | 0.46 |
| Haliburton                | 335      | -27                | -29   | 29        | 23     | 4840                   | 25               | 92                     | 780           | 0.9          | 980                | 100                                  | 2.9                  | 0.4            | 0.27                       | 0.35 |
| Halton Hills (Georgetown) | 255      | -19                | -21   | 30        | 23     | 4200                   | 28               | 119                    | 750           | 0.8          | 850                | 140                                  | 1.4                  | 0.4            | 0.29                       | 0.37 |
| Hamilton                  | 90       | -17                | -19   | 31        | 23     | 3460                   | 23               | 108                    | 810           | 0.9          | 875                | 160                                  | 1.1                  | 0.4            | 0.36                       | 0.46 |
| Hanover                   | 270      | -19                | -21   | 29        | 22     | 4300                   | 28               | 103                    | 790           | 0.9          | 1050               | 140                                  | 2.6                  | 0.4            | 0.34                       | 0.44 |
| Hastings                  | 200      | -24                | -26   | 30        | 23     | 4280                   | 25               | 92                     | 730           | 0.9          | 840                | 140                                  | 2.0                  | 0.4            | 0.32                       | 0.41 |
| Hawkesbury                | 50       | -25                | -27   | 30        | 23     | 4610                   | 23               | 103                    | 800           | 0.9          | 925                | 160                                  | 2.3                  | 0.4            | 0.32                       | 0.41 |
| Hearst                    | 245      | -35                | -37   | 29        | 21     | 6450                   | 20               | 86                     | 520           | 0.7          | 825                | 80                                   | 2.8                  | 0.3            | 0.23                       | 0.30 |
| Honey Harbour             | 180      | -24                | -26   | 29        | 23     | 4300                   | 25               | 97                     | 710           | 0.9          | 1050               | 160                                  | 2.7                  | 0.4            | 0.30                       | 0.39 |
| Hornepayne                | 360      | -37                | -40   | 28        | 21     | 6340                   | 20               | 93                     | 420           | 0.7          | 750                | 80                                   | 3.3                  | 0.4            | 0.22                       | 0.30 |
| Huntsville                | 335      | -26                | -29   | 29        | 22     | 4850                   | 25               | 103                    | 800           | 0.9          | 1000               | 120                                  | 2.9                  | 0.4            | 0.27                       | 0.35 |
| Ingersoll                 | 280      | -18                | -20   | 30        | 23     | 3920                   | 28               | 108                    | 840           | 1.0          | 950                | 180                                  | 1.7                  | 0.4            | 0.37                       | 0.48 |
| Iroquois Falls            | 275      | -33                | -36   | 29        | 21     | 6100                   | 20               | 86                     | 575           | 0.8          | 825                | 100                                  | 2.9                  | 0.3            | 0.29                       | 0.37 |
| Jellicoe                  | 330      | -36                | -39   | 28        | 21     | 6400                   | 20               | 86                     | 550           | 0.8          | 750                | 100                                  | 2.7                  | 0.4            | 0.22                       | 0.30 |
| Kapuskegong               | 245      | -34                | -36   | 29        | 21     | 6250                   | 20               | 86                     | 550           | 0.8          | 825                | 100                                  | 3.0                  | 0.3            | 0.24                       | 0.31 |
| Kemptville                | 90       | -25                | -27   | 30        | 23     | 4540                   | 25               | 92                     | 750           | 0.9          | 925                | 160                                  | 2.3                  | 0.4            | 0.32                       | 0.41 |
| Kenora                    | 370      | -33                | -35   | 28        | 22     | 5630                   | 25               | 113                    | 515           | 0.6          | 630                | 120                                  | 2.5                  | 0.3            | 0.23                       | 0.31 |
| Killaloe                  | 185      | -28                | -31   | 30        | 22     | 4960                   | 23               | 86                     | 680           | 0.8          | 825                | 120                                  | 2.7                  | 0.4            | 0.27                       | 0.35 |
| Kincardine                | 190      | -17                | -19   | 28        | 22     | 3890                   | 25               | 92                     | 800           | 1.0          | 950                | 180                                  | 2.6                  | 0.4            | 0.37                       | 0.48 |
| Kingston                  | 80       | -22                | -24   | 28        | 23     | 4000                   | 23               | 108                    | 780           | 1.0          | 950                | 180                                  | 2.1                  | 0.4            | 0.37                       | 0.47 |
| Kinmount                  | 295      | -26                | -28   | 29        | 23     | 4600                   | 25               | 108                    | 750           | 0.9          | 950                | 120                                  | 2.7                  | 0.4            | 0.27                       | 0.35 |
| Kirkland Lake             | 325      | -33                | -36   | 29        | 22     | 6000                   | 23               | 92                     | 600           | 0.8          | 875                | 100                                  | 2.9                  | 0.3            | 0.30                       | 0.39 |

Table C-2 (Continued)

Table C-2 (Continued)

| Province and Location                         | Elev., m | Design Temperature |       |           |        | Degree-Days Below 18°C | 15 Min. Rain, mm | One Day Rain, 1/50, mm | Ann. Rain, mm | Moist. Index | Ann. Tot. Ppn., mm | Driving Wind Pressures, Pa, 1/5 | Snow Load, kPa, 1/50 |                | Hourly Wind Pressures, kPa |      |
|---|----------|--------------------|-------|-----------|--------|------------------------|------------------|------------------------|---------------|--------------|--------------------|---------------------------------|----------------------|----------------|----------------------------|------|
|   |          | January            |       | July 2.5% |        |                        |                  |                        |               |              |                    |                                 | S <sub>s</sub>       | S <sub>r</sub> | 1/10                       | 1/50 |
|   |          | 2.5% °C            | 1% °C | Dry °C    | Wet °C |                        |                  |                        |               |              |                    |                                 |                      |                |                            |      |
| Kitchener                                     | 335      | -19                | -21   | 29        | 23     | 4200                   | 28               | 119                    | 780           | 0.9          | 925                | 140                             | 2.0                  | 0.4            | 0.29                       | 0.37 |
| Kitchenuhmaykoosib / Big Trout Lake           | 215      | -38                | -40   | 26        | 20     | 7450                   | 18               | 92                     | 400           | 0.75         | 600                | 150                             | 3.2                  | 0.2            | 0.31                       | 0.42 |
| Lakefield                                     | 240      | -24                | -26   | 30        | 23     | 4330                   | 25               | 92                     | 720           | 0.9          | 850                | 140                             | 2.2                  | 0.4            | 0.30                       | 0.38 |
| Lansdowne House                               | 240      | -38                | -40   | 28        | 21     | 7150                   | 23               | 92                     | 500           | 0.8          | 680                | 140                             | 3.0                  | 0.2            | 0.24                       | 0.32 |
| Leamington                                    | 190      | -15                | -17   | 31        | 24     | 3400                   | 28               | 113                    | 800           | 0.9          | 875                | 180                             | 0.8                  | 0.4            | 0.37                       | 0.47 |
| Lindsay                                       | 265      | -24                | -26   | 30        | 23     | 4320                   | 25               | 103                    | 720           | 0.8          | 850                | 140                             | 2.3                  | 0.4            | 0.30                       | 0.38 |
| Lion's Head                                   | 185      | -19                | -21   | 27        | 22     | 4300                   | 25               | 103                    | 700           | 0.9          | 950                | 180                             | 2.7                  | 0.4            | 0.37                       | 0.48 |
| Listowel                                      | 380      | -19                | -21   | 29        | 23     | 4300                   | 28               | 119                    | 800           | 0.9          | 1000               | 160                             | 2.6                  | 0.4            | 0.34                       | 0.43 |
| London  | 245      | -18                | -20   | 30        | 24     | 3900                   | 28               | 103                    | 825           | 0.9          | 975                | 180                             | 1.9                  | 0.4            | 0.37                       | 0.47 |
| Lucan   | 300      | -17                | -19   | 30        | 23     | 3900                   | 25               | 113                    | 810           | 0.9          | 1000               | 180                             | 2.3                  | 0.4            | 0.37                       | 0.48 |
| Maitland                                      | 85       | -23                | -25   | 29        | 23     | 4080                   | 25               | 103                    | 770           | 0.9          | 975                | 180                             | 2.2                  | 0.4            | 0.34                       | 0.44 |
| Markdale                                      | 425      | -20                | -22   | 29        | 22     | 4500                   | 28               | 103                    | 820           | 0.9          | 1050               | 160                             | 3.2                  | 0.4            | 0.32                       | 0.41 |
| Markham                                       | 175      | -21                | -23   | 31        | 24     | 4000                   | 25               | 86                     | 720           | 0.8          | 825                | 140                             | 1.3                  | 0.4            | 0.34                       | 0.44 |
| Martin  | 485      | -35                | -37   | 29        | 22     | 5900                   | 25               | 103                    | 560           | 0.8          | 750                | 120                             | 2.6                  | 0.3            | 0.22                       | 0.30 |
| Matheson                                      | 265      | -33                | -36   | 29        | 21     | 6080                   | 20               | 86                     | 580           | 0.8          | 825                | 100                             | 2.8                  | 0.3            | 0.30                       | 0.39 |
| Mattawa                                       | 165      | -29                | -31   | 30        | 22     | 5050                   | 23               | 86                     | 700           | 0.9          | 875                | 100                             | 2.1                  | 0.4            | 0.25                       | 0.32 |
| Midland                                       | 190      | -24                | -26   | 29        | 23     | 4200                   | 25               | 97                     | 740           | 0.9          | 1060               | 160                             | 2.7                  | 0.4            | 0.30                       | 0.39 |
| Milton  | 200      | -18                | -20   | 30        | 23     | 3920                   | 25               | 125                    | 750           | 0.9          | 850                | 160                             | 1.3                  | 0.4            | 0.34                       | 0.43 |
| Milverton                                     | 370      | -19                | -21   | 29        | 23     | 4200                   | 28               | 108                    | 800           | 0.9          | 1050               | 160                             | 2.4                  | 0.4            | 0.34                       | 0.43 |
| Minden  | 270      | -27                | -29   | 29        | 23     | 4640                   | 25               | 97                     | 780           | 0.9          | 1010               | 100                             | 2.7                  | 0.4            | 0.27                       | 0.35 |
| Mississauga                                   | 160      | -18                | -20   | 30        | 23     | 3880                   | 25               | 113                    | 720           | 0.9          | 800                | 160                             | 1.1                  | 0.4            | 0.34                       | 0.44 |
| Mississauga (Lester B. Pearson Int'l Airport) | 170      | -20                | -22   | 31        | 24     | 3890                   | 26               | 108                    | 685           | 0.8          | 790                | 160                             | 1.1                  | 0.4            | 0.34                       | 0.44 |
| Mississauga (Port Credit)                     | 75       | -18                | -20   | 29        | 23     | 3780                   | 25               | 108                    | 720           | 0.9          | 800                | 160                             | 0.9                  | 0.4            | 0.37                       | 0.48 |
| Mitchell                                      | 335      | -18                | -20   | 29        | 23     | 4100                   | 28               | 113                    | 810           | 0.9          | 1050               | 160                             | 2.4                  | 0.4            | 0.35                       | 0.45 |
| Moosonee                                      | 10       | -36                | -38   | 28        | 22     | 6800                   | 18               | 81                     | 500           | 0.8          | 700                | 160                             | 2.7                  | 0.3            | 0.26                       | 0.35 |
| Morrisburg                                    | 75       | -23                | -25   | 30        | 23     | 4370                   | 25               | 103                    | 800           | 0.9          | 950                | 180                             | 2.3                  | 0.4            | 0.32                       | 0.41 |

Table C-2 (Continued)

Table C-2 (Continued)

| Province and Location      | Elev., m | Design Temperature |       |           |        | Degree-Days Below 18°C | 15 Min. Rain, mm | One Day Rain, 1/50, mm | Ann. Rain, mm | Moist. Index | Ann. Tot. Ppn., mm | Driving Rain Wind Pressures, Pa, 1/5 | Snow Load, kPa, 1/50 |                | Hourly Wind Pressures, kPa |      |
|----------------------------|----------|--------------------|-------|-----------|--------|------------------------|------------------|------------------------|---------------|--------------|--------------------|--------------------------------------|----------------------|----------------|----------------------------|------|
|                            |          | January            |       | July 2.5% |        |                        |                  |                        |               |              |                    |                                      | S <sub>s</sub>       | S <sub>r</sub> | 1/10                       | 1/50 |
|                            |          | 2.5% °C            | 1% °C | Dry °C    | Wet °C |                        |                  |                        |               |              |                    |                                      |                      |                |                            |      |
| Mount Forest               | 420      | -21                | -24   | 28        | 22     | 4700                   | 28               | 103                    | 740           | 0.9          | 940                | 140                                  | 2.7                  | 0.4            | 0.32                       | 0.41 |
| Nakina                     | 325      | -36                | -38   | 28        | 21     | 6500                   | 20               | 86                     | 540           | 0.8          | 750                | 100                                  | 2.8                  | 0.4            | 0.22                       | 0.30 |
| Nanicoke (Jarvis)          | 205      | -17                | -18   | 30        | 23     | 3700                   | 28               | 108                    | 840           | 1.0          | 900                | 160                                  | 1.4                  | 0.4            | 0.37                       | 0.48 |
| Nanicoke (Port Dover)      | 180      | -15                | -17   | 30        | 24     | 3600                   | 25               | 108                    | 860           | 1.0          | 950                | 140                                  | 1.2                  | 0.4            | 0.37                       | 0.48 |
| Napanee                    | 90       | -22                | -24   | 29        | 23     | 4140                   | 23               | 92                     | 770           | 0.9          | 900                | 160                                  | 1.9                  | 0.4            | 0.34                       | 0.43 |
| Newcastle                  | 115      | -20                | -22   | 30        | 23     | 3990                   | 23               | 86                     | 760           | 0.9          | 830                | 160                                  | 1.5                  | 0.4            | 0.37                       | 0.48 |
| Newcastle (Bowmanville)    | 95       | -20                | -22   | 30        | 23     | 4000                   | 23               | 86                     | 760           | 0.90         | 830                | 160                                  | 1.4                  | 0.4            | 0.37                       | 0.48 |
| New Liskeard               | 180      | -32                | -35   | 30        | 22     | 5570                   | 23               | 92                     | 570           | 0.8          | 810                | 100                                  | 2.6                  | 0.4            | 0.34                       | 0.43 |
| Newmarket                  | 185      | -22                | -24   | 30        | 23     | 4260                   | 28               | 108                    | 700           | 0.8          | 800                | 140                                  | 2.0                  | 0.4            | 0.30                       | 0.38 |
| Niagara Falls              | 210      | -16                | -18   | 30        | 23     | 3600                   | 23               | 96                     | 810           | 0.9          | 950                | 160                                  | 1.8                  | 0.4            | 0.34                       | 0.43 |
| North Bay                  | 210      | -28                | -30   | 28        | 22     | 5150                   | 25               | 95                     | 775           | 0.9          | 975                | 120                                  | 2.2                  | 0.4            | 0.27                       | 0.34 |
| Norwood                    | 225      | -24                | -26   | 30        | 23     | 4320                   | 25               | 92                     | 720           | 0.8          | 850                | 120                                  | 2.1                  | 0.4            | 0.32                       | 0.41 |
| Oakville                   | 90       | -18                | -20   | 30        | 23     | 3760                   | 23               | 97                     | 750           | 0.9          | 850                | 160                                  | 1.1                  | 0.4            | 0.37                       | 0.47 |
| Orangeville                | 430      | -21                | -23   | 29        | 23     | 4450                   | 28               | 108                    | 730           | 0.8          | 875                | 140                                  | 2.3                  | 0.4            | 0.28                       | 0.36 |
| Orillia                    | 230      | -25                | -27   | 29        | 23     | 4260                   | 25               | 103                    | 740           | 0.9          | 1000               | 120                                  | 2.4                  | 0.4            | 0.28                       | 0.36 |
| Oshawa                     | 110      | -19                | -21   | 30        | 23     | 3860                   | 23               | 86                     | 760           | 0.9          | 875                | 160                                  | 1.4                  | 0.4            | 0.37                       | 0.48 |
| Ottawa (Metropolitan)      |          |                    |       |           |        |                        |                  |                        |               |              |                    |                                      |                      |                |                            |      |
| Ottawa (Barrhaven)         | 98       | -25                | -27   | 30        | 23     | 4500                   | 25               | 92                     | 750           | 0.8          | 900                | 160                                  | 2.4                  | 0.4            | 0.32                       | 0.41 |
| Ottawa (City Hall)         | 70       | -25                | -27   | 30        | 23     | 4440                   | 23               | 86                     | 750           | 0.8          | 900                | 160                                  | 2.4                  | 0.4            | 0.32                       | 0.41 |
| Ottawa (Kanata)            | 98       | -25                | -27   | 30        | 23     | 4520                   | 25               | 92                     | 730           | 0.8          | 900                | 160                                  | 2.5                  | 0.4            | 0.32                       | 0.41 |
| Ottawa (M-C Int'l Airport) | 125      | -25                | -27   | 30        | 23     | 4500                   | 24               | 89                     | 750           | 0.8          | 900                | 160                                  | 2.4                  | 0.4            | 0.32                       | 0.41 |
| Ottawa (Orléans)           | 70       | -26                | -28   | 30        | 23     | 4500                   | 23               | 91                     | 750           | 0.8          | 900                | 160                                  | 2.4                  | 0.4            | 0.32                       | 0.41 |
| Owen Sound                 | 215      | -19                | -21   | 29        | 22     | 4030                   | 28               | 113                    | 760           | 0.9          | 1075               | 160                                  | 2.8                  | 0.4            | 0.34                       | 0.44 |
| Pagwa River                | 185      | -35                | -37   | 28        | 21     | 6500                   | 20               | 86                     | 540           | 0.8          | 825                | 80                                   | 2.7                  | 0.4            | 0.22                       | 0.30 |
| Paris                      | 245      | -18                | -20   | 30        | 23     | 4000                   | 23               | 96                     | 790           | 0.9          | 925                | 160                                  | 1.4                  | 0.4            | 0.33                       | 0.42 |
| Parkhill                   | 205      | -16                | -18   | 31        | 23     | 3800                   | 25               | 103                    | 800           | 0.9          | 925                | 180                                  | 2.1                  | 0.4            | 0.37                       | 0.48 |

Table C-2 (Continued)

Table C-2 (Continued)

| Province and Location        | Elev., m | Design Temperature |       |           |        | Degree-Days Below 18°C | 15 Min. Rain, mm | One Day Rain, 1/50, mm | Ann. Rain, mm | Moist. Index | Ann. Tot. Ppn., mm | Driving Wind Pressures, Pa, 1/5 | Snow Load, kPa, 1/50 |                | Hourly Wind Pressures, kPa |      |
|------------------------------|----------|--------------------|-------|-----------|--------|------------------------|------------------|------------------------|---------------|--------------|--------------------|---------------------------------|----------------------|----------------|----------------------------|------|
|                              |          | January            |       | July 2.5% |        |                        |                  |                        |               |              |                    |                                 | S <sub>s</sub>       | S <sub>r</sub> | 1/10                       | 1/50 |
|                              |          | 2.5% °C            | 1% °C | Dry °C    | Wet °C |                        |                  |                        |               |              |                    |                                 |                      |                |                            |      |
| Parry Sound                  | 215      | -24                | -26   | 28        | 22     | 4640                   | 23               | 97                     | 820           | 1.0          | 1050               | 160                             | 2.8                  | 0.4            | 0.30                       | 0.39 |
| Pelham (Fonthill)            | 230      | -15                | -17   | 30        | 23     | 3690                   | 23               | 96                     | 820           | 0.9          | 950                | 160                             | 2.1                  | 0.4            | 0.33                       | 0.42 |
| Pembroke                     | 125      | -28                | -31   | 30        | 23     | 4980                   | 23               | 105                    | 640           | 0.8          | 825                | 100                             | 2.5                  | 0.4            | 0.27                       | 0.35 |
| Penetanguishene              | 220      | -24                | -26   | 29        | 23     | 4200                   | 25               | 97                     | 720           | 0.9          | 1050               | 160                             | 2.8                  | 0.4            | 0.30                       | 0.39 |
| Perth                        | 130      | -25                | -27   | 30        | 23     | 4540                   | 25               | 92                     | 730           | 0.8          | 900                | 140                             | 2.3                  | 0.4            | 0.32                       | 0.41 |
| Petawawa                     | 135      | -29                | -31   | 30        | 23     | 4980                   | 23               | 92                     | 640           | 0.8          | 825                | 100                             | 2.6                  | 0.4            | 0.27                       | 0.35 |
| Peterborough                 | 200      | -23                | -25   | 30        | 23     | 4400                   | 25               | 92                     | 710           | 0.8          | 840                | 140                             | 2.0                  | 0.4            | 0.32                       | 0.41 |
| Petrolia                     | 195      | -16                | -18   | 31        | 24     | 3640                   | 25               | 108                    | 810           | 0.9          | 920                | 180                             | 1.3                  | 0.4            | 0.37                       | 0.47 |
| Pickering (Dunbarton)        | 85       | -19                | -21   | 30        | 23     | 3800                   | 23               | 92                     | 730           | 0.9          | 825                | 140                             | 1.0                  | 0.4            | 0.37                       | 0.48 |
| Pictou                       | 95       | -21                | -23   | 29        | 23     | 3980                   | 23               | 92                     | 770           | 0.9          | 940                | 160                             | 2.0                  | 0.4            | 0.38                       | 0.49 |
| Plattsville                  | 300      | -19                | -21   | 29        | 23     | 4150                   | 28               | 103                    | 820           | 0.9          | 950                | 140                             | 1.9                  | 0.4            | 0.33                       | 0.42 |
| Point Alexander              | 150      | -29                | -32   | 30        | 22     | 4960                   | 23               | 92                     | 650           | 0.8          | 850                | 100                             | 2.5                  | 0.4            | 0.27                       | 0.35 |
| Port Burwell                 | 195      | -15                | -17   | 30        | 24     | 3800                   | 25               | 92                     | 930           | 1.1          | 1000               | 180                             | 1.2                  | 0.4            | 0.37                       | 0.47 |
| Port Colborne                | 180      | -15                | -17   | 30        | 24     | 3600                   | 23               | 108                    | 850           | 1.0          | 1000               | 160                             | 2.1                  | 0.4            | 0.36                       | 0.46 |
| Port Elgin                   | 205      | -17                | -19   | 28        | 22     | 4100                   | 25               | 92                     | 790           | 0.9          | 850                | 180                             | 2.8                  | 0.4            | 0.37                       | 0.48 |
| Port Hope                    | 100      | -21                | -23   | 29        | 23     | 3970                   | 23               | 94                     | 760           | 0.9          | 825                | 180                             | 1.2                  | 0.4            | 0.37                       | 0.48 |
| Port Perry                   | 270      | -22                | -24   | 30        | 23     | 4260                   | 25               | 97                     | 720           | 0.8          | 850                | 140                             | 2.4                  | 0.4            | 0.34                       | 0.44 |
| Port Stanley                 | 180      | -15                | -17   | 31        | 24     | 3850                   | 25               | 92                     | 940           | 1.1          | 975                | 180                             | 1.2                  | 0.4            | 0.37                       | 0.47 |
| Prescott                     | 90       | -23                | -25   | 29        | 23     | 4120                   | 25               | 103                    | 770           | 0.9          | 975                | 180                             | 2.2                  | 0.4            | 0.34                       | 0.44 |
| Princeton                    | 280      | -18                | -20   | 30        | 23     | 4000                   | 25               | 97                     | 810           | 0.9          | 925                | 160                             | 1.5                  | 0.4            | 0.33                       | 0.42 |
| Raith                        | 475      | -34                | -37   | 28        | 22     | 5900                   | 23               | 97                     | 570           | 0.8          | 750                | 120                             | 2.7                  | 0.4            | 0.22                       | 0.30 |
| Rayside-Balfour (Chelmsford) | 270      | -28                | -30   | 29        | 21     | 5200                   | 25               | 92                     | 650           | 0.8          | 850                | 180                             | 2.5                  | 0.4            | 0.35                       | 0.45 |
| Red Lake                     | 360      | -35                | -37   | 28        | 21     | 6220                   | 20               | 92                     | 470           | 0.7          | 630                | 120                             | 2.6                  | 0.3            | 0.22                       | 0.30 |
| Renfrew                      | 115      | -27                | -30   | 30        | 23     | 4900                   | 23               | 97                     | 620           | 0.8          | 810                | 140                             | 2.5                  | 0.4            | 0.27                       | 0.35 |
| Richmond Hill                | 230      | -21                | -23   | 31        | 24     | 4000                   | 25               | 97                     | 740           | 0.8          | 850                | 140                             | 1.5                  | 0.4            | 0.34                       | 0.44 |
| Rockland                     | 50       | -26                | -28   | 30        | 23     | 4600                   | 23               | 92                     | 780           | 0.9          | 950                | 160                             | 2.4                  | 0.4            | 0.31                       | 0.40 |

Table C-2 (Continued)

Table C-2 (Continued)

| Province and Location | Elev., m | Design Temperature |       |           |        | Degree-Days Below 18°C | 15 Min. Rain, mm | One Day Rain, 1/50, mm | Ann. Rain, mm | Moist. Index | Ann. Tot. Ppn., mm | Driving Wind Pressures, Pa, 1/5 | Snow Load, kPa, 1/50 |                | Hourly Wind Pressures, kPa |      |
|-----------------------|----------|--------------------|-------|-----------|--------|------------------------|------------------|------------------------|---------------|--------------|--------------------|---------------------------------|----------------------|----------------|----------------------------|------|
|                       |          | January            |       | July 2.5% |        |                        |                  |                        |               |              |                    |                                 | S <sub>s</sub>       | S <sub>r</sub> | 1/10                       | 1/50 |
|                       |          | 2.5% °C            | 1% °C | Dry °C    | Wet °C |                        |                  |                        |               |              |                    |                                 |                      |                |                            |      |
| Sarnia                | 190      | -16                | -18   | 31        | 24     | 3750                   | 25               | 100                    | 750           | 0.9          | 825                | 180                             | 1.1                  | 0.4            | 0.37                       | 0.47 |
| Sault Ste. Marie      | 190      | -25                | -28   | 29        | 22     | 4960                   | 23               | 97                     | 660           | 0.9          | 950                | 200                             | 3.1                  | 0.4            | 0.33                       | 0.44 |
| Schreiber             | 310      | -34                | -36   | 27        | 21     | 5960                   | 20               | 103                    | 600           | 0.8          | 850                | 160                             | 3.3                  | 0.4            | 0.29                       | 0.39 |
| Seaforth              | 310      | -17                | -19   | 30        | 23     | 4100                   | 25               | 108                    | 810           | 0.9          | 1025               | 160                             | 2.5                  | 0.4            | 0.35                       | 0.45 |
| Shelburne             | 495      | -22                | -24   | 29        | 23     | 4700                   | 28               | 108                    | 740           | 0.9          | 900                | 150                             | 3.1                  | 0.4            | 0.31                       | 0.40 |
| Simcoe                | 210      | -17                | -19   | 30        | 24     | 3700                   | 28               | 113                    | 860           | 1.0          | 950                | 160                             | 1.3                  | 0.4            | 0.35                       | 0.45 |
| Sioux Lookout         | 375      | -34                | -36   | 28        | 22     | 5950                   | 25               | 97                     | 520           | 0.7          | 710                | 100                             | 2.6                  | 0.3            | 0.22                       | 0.30 |
| Smiths Falls          | 130      | -25                | -27   | 30        | 23     | 4540                   | 25               | 92                     | 730           | 0.8          | 850                | 140                             | 2.3                  | 0.4            | 0.32                       | 0.41 |
| Smithville            | 185      | -16                | -18   | 30        | 23     | 3650                   | 23               | 108                    | 800           | 0.9          | 900                | 160                             | 1.5                  | 0.4            | 0.33                       | 0.42 |
| Smooth Rock Falls     | 235      | -34                | -36   | 29        | 21     | 6250                   | 20               | 92                     | 560           | 0.8          | 850                | 80                              | 2.7                  | 0.3            | 0.25                       | 0.32 |
| Southampton           | 180      | -17                | -19   | 28        | 22     | 4100                   | 25               | 92                     | 800           | 1.0          | 830                | 180                             | 2.7                  | 0.4            | 0.37                       | 0.48 |
| South River           | 355      | -27                | -29   | 29        | 22     | 5090                   | 25               | 103                    | 830           | 1.0          | 975                | 120                             | 2.8                  | 0.4            | 0.27                       | 0.35 |
| St. Catharines        | 105      | -16                | -18   | 30        | 23     | 3540                   | 23               | 92                     | 770           | 0.9          | 850                | 160                             | 1.0                  | 0.4            | 0.36                       | 0.46 |
| St. Marys             | 310      | -18                | -20   | 30        | 23     | 4000                   | 28               | 108                    | 820           | 1.0          | 1025               | 160                             | 2.2                  | 0.4            | 0.37                       | 0.47 |
| St. Thomas            | 225      | -16                | -18   | 31        | 24     | 3780                   | 25               | 103                    | 900           | 1.0          | 975                | 180                             | 1.4                  | 0.4            | 0.37                       | 0.47 |
| Stirling              | 120      | -23                | -25   | 30        | 23     | 4220                   | 25               | 97                     | 740           | 0.9          | 850                | 120                             | 1.7                  | 0.4            | 0.31                       | 0.40 |
| Stratford             | 360      | -18                | -20   | 29        | 23     | 4050                   | 28               | 113                    | 820           | 1.0          | 1050               | 160                             | 2.3                  | 0.4            | 0.35                       | 0.45 |
| Strathroy             | 225      | -17                | -19   | 31        | 24     | 3780                   | 25               | 103                    | 770           | 0.9          | 950                | 180                             | 1.9                  | 0.4            | 0.37                       | 0.47 |
| Sturgeon Falls        | 205      | -28                | -30   | 29        | 21     | 5200                   | 25               | 95                     | 700           | 0.9          | 910                | 140                             | 2.4                  | 0.4            | 0.27                       | 0.35 |
| Sturbury              | 275      | -28                | -30   | 29        | 21     | 5180                   | 25               | 97                     | 650           | 0.8          | 875                | 200                             | 2.5                  | 0.4            | 0.36                       | 0.46 |
| Sundridge             | 340      | -27                | -29   | 29        | 22     | 5080                   | 25               | 97                     | 840           | 1.0          | 975                | 120                             | 2.8                  | 0.4            | 0.27                       | 0.35 |
| Tavistock             | 340      | -19                | -21   | 29        | 23     | 4100                   | 28               | 113                    | 820           | 1.0          | 1010               | 160                             | 2.1                  | 0.4            | 0.35                       | 0.45 |
| Temagami              | 300      | -30                | -33   | 30        | 22     | 5420                   | 23               | 92                     | 650           | 0.8          | 875                | 120                             | 2.6                  | 0.4            | 0.29                       | 0.37 |
| Thamesford            | 280      | -19                | -21   | 30        | 23     | 3950                   | 28               | 108                    | 820           | 0.9          | 975                | 160                             | 1.9                  | 0.4            | 0.37                       | 0.48 |
| Thedford              | 205      | -16                | -18   | 31        | 23     | 3710                   | 25               | 103                    | 810           | 1.0          | 900                | 180                             | 2.1                  | 0.4            | 0.37                       | 0.48 |
| Thunder Bay           | 210      | -31                | -33   | 29        | 21     | 5650                   | 23               | 108                    | 560           | 0.8          | 710                | 160                             | 2.9                  | 0.4            | 0.29                       | 0.39 |
| Tillsonburg           | 215      | -17                | -19   | 30        | 24     | 3840                   | 25               | 103                    | 880           | 1.0          | 980                | 160                             | 1.3                  | 0.4            | 0.34                       | 0.44 |

Table C-2 (Continued)

| Province and Location       | Elev., m | Design Temperature |       |           |        | Degree-Days Below 18°C | 15 Min. Rain, mm | One Day Rain, 1/50, mm | Ann. Rain, mm | Moist. Index | Ann. Tot. Ppn., mm | Driving Wind Pressures, Pa, 1/5 | Snow Load, kPa, 1/50 |                | Hourly Wind Pressures, kPa |      |
|-----------------------------|----------|--------------------|-------|-----------|--------|------------------------|------------------|------------------------|---------------|--------------|--------------------|---------------------------------|----------------------|----------------|----------------------------|------|
|                             |          | January            |       | July 2.5% |        |                        |                  |                        |               |              |                    |                                 | S <sub>s</sub>       | S <sub>r</sub> | 1/10                       | 1/50 |
|                             |          | 2.5% °C            | 1% °C | Dry °C    | Wet °C |                        |                  |                        |               |              |                    |                                 |                      |                |                            |      |
| Timmins                     | 300      | -34                | -36   | 29        | 21     | 5940                   | 20               | 108                    | 560           | 0.8          | 875                | 100                             | 3.1                  | 0.3            | 0.27                       | 0.35 |
| Timmins (Porcupine)         | 295      | -34                | -36   | 29        | 21     | 6000                   | 20               | 103                    | 560           | 0.8          | 875                | 100                             | 2.9                  | 0.3            | 0.29                       | 0.37 |
| Toronto Metropolitan Region |          |                    |       |           |        |                        |                  |                        |               |              |                    |                                 |                      |                |                            |      |
| Etobicoke                   | 160      | -20                | -22   | 31        | 24     | 3800                   | 26               | 108                    | 720           | 0.8          | 800                | 160                             | 1.1                  | 0.4            | 0.34                       | 0.44 |
| North York                  | 175      | -20                | -22   | 31        | 24     | 3760                   | 25               | 108                    | 730           | 0.8          | 850                | 150                             | 1.2                  | 0.4            | 0.34                       | 0.44 |
| Scarborough                 | 180      | -20                | -22   | 31        | 24     | 3800                   | 25               | 92                     | 730           | 0.9          | 825                | 160                             | 1.2                  | 0.4            | 0.37                       | 0.47 |
| Toronto (City Hall)         | 90       | -18                | -20   | 31        | 23     | 3520                   | 25               | 97                     | 720           | 0.9          | 820                | 160                             | 0.9                  | 0.4            | 0.34                       | 0.44 |
| Trenton                     | 80       | -22                | -24   | 29        | 23     | 4110                   | 23               | 97                     | 760           | 0.9          | 850                | 160                             | 1.6                  | 0.4            | 0.37                       | 0.47 |
| Trout Creek                 | 330      | -27                | -29   | 29        | 22     | 5100                   | 25               | 103                    | 780           | 0.9          | 975                | 120                             | 2.7                  | 0.4            | 0.27                       | 0.35 |
| Uxbridge                    | 275      | -22                | -24   | 30        | 23     | 4240                   | 25               | 103                    | 700           | 0.8          | 850                | 140                             | 2.4                  | 0.4            | 0.33                       | 0.42 |
| Vaughan (Woodbridge)        | 165      | -20                | -22   | 31        | 24     | 4100                   | 26               | 113                    | 700           | 0.8          | 800                | 140                             | 1.1                  | 0.4            | 0.34                       | 0.44 |
| Vittoria                    | 215      | -15                | -17   | 30        | 24     | 3680                   | 25               | 113                    | 880           | 1.0          | 950                | 160                             | 1.3                  | 0.4            | 0.37                       | 0.47 |
| Walkerton                   | 275      | -18                | -20   | 30        | 22     | 4300                   | 28               | 103                    | 790           | 0.9          | 1025               | 160                             | 2.7                  | 0.4            | 0.36                       | 0.46 |
| Wallaceburg                 | 180      | -16                | -18   | 31        | 24     | 3600                   | 28               | 97                     | 760           | 0.9          | 825                | 180                             | 0.9                  | 0.4            | 0.35                       | 0.45 |
| Waterloo                    | 330      | -19                | -21   | 29        | 23     | 4200                   | 28               | 119                    | 780           | 0.9          | 925                | 160                             | 2.0                  | 0.4            | 0.29                       | 0.37 |
| Watford                     | 240      | -17                | -19   | 31        | 24     | 3740                   | 25               | 108                    | 790           | 0.9          | 950                | 160                             | 1.9                  | 0.4            | 0.37                       | 0.47 |
| Wawa                        | 290      | -34                | -36   | 26        | 21     | 5840                   | 20               | 93                     | 725           | 0.9          | 950                | 160                             | 3.4                  | 0.4            | 0.30                       | 0.39 |
| Welland                     | 180      | -15                | -17   | 30        | 23     | 3670                   | 23               | 103                    | 840           | 1.0          | 975                | 160                             | 2.0                  | 0.4            | 0.34                       | 0.43 |
| West Lorne                  | 215      | -16                | -18   | 31        | 24     | 3700                   | 28               | 103                    | 840           | 1.0          | 900                | 180                             | 1.3                  | 0.4            | 0.37                       | 0.47 |
| Whitby                      | 85       | -20                | -22   | 30        | 23     | 3820                   | 23               | 86                     | 760           | 0.9          | 850                | 160                             | 1.2                  | 0.4            | 0.37                       | 0.48 |
| Whitby (Brooklin)           | 160      | -20                | -22   | 30        | 23     | 4010                   | 23               | 86                     | 770           | 0.9          | 850                | 140                             | 1.9                  | 0.4            | 0.35                       | 0.45 |
| White River                 | 375      | -39                | -42   | 28        | 21     | 6150                   | 20               | 92                     | 575           | 0.8          | 825                | 100                             | 3.6                  | 0.4            | 0.22                       | 0.30 |
| Warton                      | 185      | -19                | -21   | 29        | 22     | 4300                   | 25               | 103                    | 740           | 0.9          | 1000               | 180                             | 2.7                  | 0.4            | 0.34                       | 0.44 |
| Windsor                     | 185      | -16                | -18   | 32        | 24     | 3400                   | 28               | 103                    | 800           | 0.9          | 900                | 180                             | 0.8                  | 0.4            | 0.37                       | 0.47 |
| Wingham                     | 310      | -18                | -20   | 30        | 23     | 4220                   | 28               | 108                    | 780           | 0.9          | 1050               | 160                             | 2.6                  | 0.4            | 0.36                       | 0.46 |
| Woodstock                   | 300      | -19                | -21   | 30        | 23     | 3910                   | 28               | 113                    | 830           | 0.9          | 930                | 160                             | 1.9                  | 0.4            | 0.34                       | 0.44 |

Table C-2 (Continued)

Table C-2 (Continued)

| Province and Location | Elev., m | Design Temperature |       |           |        | Degree-Days Below 18°C | 15 Min. Rain, mm | One Day Rain, 1/50, mm | Ann. Rain, mm | Moist. Index | Ann. Tot. Ppn., mm | Driving Wind Pressures, Pa, 1/5 | Snow Load, kPa, 1/50 |                | Hourly Wind Pressures, kPa |      |
|-----------------------|----------|--------------------|-------|-----------|--------|------------------------|------------------|------------------------|---------------|--------------|--------------------|---------------------------------|----------------------|----------------|----------------------------|------|
|                       |          | January            |       | July 2.5% |        |                        |                  |                        |               |              |                    |                                 | S <sub>s</sub>       | S <sub>r</sub> | 1/10                       | 1/50 |
|                       |          | 2.5% °C            | 1% °C | Dry °C    | Wet °C |                        |                  |                        |               |              |                    |                                 |                      |                |                            |      |
| Wyoming               | 215      | -16                | -18   | 31        | 24     | 3700                   | 25               | 103                    | 815           | 0.9          | 900                | 180                             | 1.6                  | 0.4            | 0.37                       | 0.47 |
| <b>Quebec</b>         |          |                    |       |           |        |                        |                  |                        |               |              |                    |                                 |                      |                |                            |      |
| Acton Vale            | 95       | -24                | -27   | 30        | 23     | 4620                   | 21               | 107                    | 860           | 1.0          | 1050               | 180                             | 2.3                  | 0.4            | 0.27                       | 0.35 |
| Alma                  | 110      | -31                | -33   | 28        | 22     | 5800                   | 20               | 91                     | 700           | 0.9          | 950                | 160                             | 3.3                  | 0.4            | 0.27                       | 0.35 |
| Amos                  | 295      | -34                | -36   | 28        | 21     | 6160                   | 20               | 91                     | 670           | 0.9          | 920                | 100                             | 3.2                  | 0.3            | 0.25                       | 0.32 |
| Asbestos              | 245      | -26                | -28   | 29        | 22     | 4800                   | 23               | 96                     | 870           | 1.0          | 1050               | 160                             | 2.8                  | 0.6            | 0.27                       | 0.35 |
| Aylmer                | 90       | -25                | -28   | 30        | 23     | 4520                   | 23               | 91                     | 730           | 0.8          | 900                | 160                             | 2.5                  | 0.4            | 0.32                       | 0.41 |
| Baie-Comeau           | 60       | -27                | -29   | 25        | 19     | 6020                   | 16               | 91                     | 680           | 1.0          | 1000               | 220                             | 4.3                  | 0.4            | 0.39                       | 0.50 |
| Baie-Saint-Paul       | 20       | -27                | -29   | 28        | 21     | 5280                   | 18               | 102                    | 730           | 0.9          | 1000               | 180                             | 3.4                  | 0.6            | 0.37                       | 0.48 |
| Beaufort              | 45       | -26                | -29   | 28        | 22     | 5100                   | 20               | 107                    | 980           | 1.1          | 1200               | 200                             | 3.4                  | 0.6            | 0.33                       | 0.42 |
| Bedford               | 55       | -24                | -26   | 29        | 23     | 4420                   | 23               | 91                     | 880           | 1.0          | 1260               | 160                             | 2.1                  | 0.4            | 0.29                       | 0.37 |
| Belœil                | 25       | -24                | -26   | 30        | 23     | 4500                   | 23               | 91                     | 840           | 1.0          | 1025               | 180                             | 2.4                  | 0.4            | 0.29                       | 0.37 |
| Brome                 | 210      | -25                | -27   | 29        | 23     | 4730                   | 23               | 96                     | 990           | 1.1          | 1240               | 160                             | 2.5                  | 0.4            | 0.29                       | 0.37 |
| Brossard              | 15       | -24                | -26   | 30        | 23     | 4420                   | 23               | 91                     | 800           | 0.9          | 1025               | 180                             | 2.4                  | 0.4            | 0.34                       | 0.44 |
| Buckingham            | 130      | -26                | -28   | 30        | 23     | 4880                   | 23               | 91                     | 810           | 0.9          | 990                | 160                             | 2.6                  | 0.4            | 0.31                       | 0.40 |
| Campbell's Bay        | 115      | -28                | -30   | 30        | 23     | 4900                   | 23               | 96                     | 700           | 0.8          | 850                | 140                             | 2.6                  | 0.4            | 0.25                       | 0.32 |
| Chambly               | 20       | -24                | -26   | 30        | 23     | 4450                   | 23               | 91                     | 850           | 1.0          | 1000               | 160                             | 2.3                  | 0.4            | 0.31                       | 0.40 |
| Coaticook             | 295      | -25                | -27   | 28        | 22     | 4750                   | 23               | 96                     | 860           | 1.0          | 1060               | 160                             | 2.3                  | 0.6            | 0.27                       | 0.35 |
| Contrecoeur           | 10       | -25                | -27   | 30        | 23     | 4500                   | 20               | 102                    | 810           | 0.9          | 1000               | 180                             | 2.8                  | 0.4            | 0.34                       | 0.43 |
| Cowansville           | 120      | -25                | -27   | 29        | 23     | 4540                   | 23               | 91                     | 940           | 1.0          | 1150               | 160                             | 2.3                  | 0.4            | 0.29                       | 0.37 |
| Deux-Montagnes        | 25       | -25                | -27   | 29        | 23     | 4440                   | 23               | 96                     | 820           | 0.9          | 1025               | 160                             | 2.4                  | 0.4            | 0.29                       | 0.37 |
| Dolbeau               | 120      | -32                | -34   | 28        | 22     | 6250                   | 22               | 91                     | 670           | 0.9          | 900                | 140                             | 3.5                  | 0.3            | 0.27                       | 0.35 |
| Drummondville         | 85       | -26                | -28   | 30        | 23     | 4700                   | 22               | 107                    | 870           | 1.0          | 1075               | 180                             | 2.5                  | 0.4            | 0.27                       | 0.35 |
| Farnham               | 60       | -24                | -26   | 29        | 23     | 4500                   | 23               | 96                     | 910           | 1.0          | 1050               | 180                             | 2.5                  | 0.4            | 0.29                       | 0.37 |
| Fort-Coulonge         | 110      | -28                | -30   | 30        | 23     | 4950                   | 23               | 96                     | 720           | 0.9          | 900                | 100                             | 2.5                  | 0.4            | 0.25                       | 0.32 |
| Gagnon                | 545      | -34                | -36   | 24        | 19     | 7600                   | 17               | 80                     | 580           | 0.9          | 925                | 140                             | 4.6                  | 0.4            | 0.30                       | 0.39 |
| Gaspé                 | 55       | -25                | -26   | 26        | 20     | 5500                   | 19               | 118                    | 760           | 1.0          | 1100               | 300                             | 4.3                  | 0.6            | 0.37                       | 0.48 |
| Gatineau              | 95       | -25                | -28   | 30        | 23     | 4600                   | 23               | 91                     | 790           | 0.9          | 950                | 160                             | 2.5                  | 0.4            | 0.32                       | 0.41 |

Table C-2 (Continued)

| Province and Location | Elev., m | Design Temperature |       |           |        | Degree-Days Below 18°C | 15 Min. Rain, mm | One Day Rain, 1/50, mm | Ann. Rain, mm | Moist. Index | Ann. Tot. Ppn., mm | Driving Wind Pressures, Pa, 1/5 | Snow Load, kPa, 1/50 |                | Hourly Wind Pressures, kPa |      |
|-----------------------|----------|--------------------|-------|-----------|--------|------------------------|------------------|------------------------|---------------|--------------|--------------------|---------------------------------|----------------------|----------------|----------------------------|------|
|                       |          | January            |       | July 2.5% |        |                        |                  |                        |               |              |                    |                                 | S <sub>s</sub>       | S <sub>r</sub> | 1/10                       | 1/50 |
|                       |          | 2.5% °C            | 1% °C | Dry °C    | Wet °C |                        |                  |                        |               |              |                    |                                 |                      |                |                            |      |
| Gracefield            | 175      | -28                | -31   | 30        | 23     | 5080                   | 23               | 96                     | 700           | 0.9          | 950                | 140                             | 2.6                  | 0.4            | 0.25                       | 0.32 |
| Granby                | 120      | -25                | -27   | 29        | 23     | 4500                   | 23               | 102                    | 940           | 1.0          | 1175               | 160                             | 2.3                  | 0.4            | 0.27                       | 0.35 |
| Harrington Harbour    | 30       | -27                | -29   | 19        | 16     | 6150                   | 15               | 96                     | 900           | 1.2          | 1150               | 300                             | 4.9                  | 0.6            | 0.56                       | 0.72 |
| Havre-Saint-Pierre    | 5        | -27                | -29   | 22        | 18     | 6100                   | 15               | 96                     | 780           | 1.1          | 1125               | 300                             | 4.1                  | 0.6            | 0.49                       | 0.63 |
| Hemmingford           | 75       | -24                | -26   | 30        | 23     | 4380                   | 23               | 91                     | 770           | 0.9          | 1025               | 160                             | 2.4                  | 0.4            | 0.31                       | 0.40 |
| Hull                  | 65       | -25                | -28   | 30        | 23     | 4550                   | 23               | 91                     | 730           | 0.8          | 900                | 160                             | 2.4                  | 0.4            | 0.32                       | 0.41 |
| Iberville             | 35       | -24                | -26   | 29        | 23     | 4450                   | 23               | 91                     | 880           | 1.0          | 1010               | 160                             | 2.2                  | 0.4            | 0.32                       | 0.41 |
| Inukjuak              | 5        | -36                | -38   | 21        | 15     | 9150                   | 9                | 54                     | 270           | 0.9          | 420                | 240                             | 4.1                  | 0.2            | 0.37                       | 0.48 |
| Joliette              | 45       | -26                | -28   | 29        | 23     | 4720                   | 21               | 102                    | 790           | 0.9          | 1000               | 160                             | 3.1                  | 0.4            | 0.28                       | 0.36 |
| Kuujuuaq              | 25       | -37                | -39   | 24        | 17     | 8550                   | 9                | 54                     | 280           | 0.8          | 525                | 260                             | 4.8                  | 0.2            | 0.47                       | 0.60 |
| Kuujuuarapik          | 20       | -36                | -38   | 25        | 17     | 7990                   | 12               | 80                     | 410           | 0.9          | 610                | 180                             | 4.2                  | 0.3            | 0.37                       | 0.48 |
| Lachute               | 65       | -26                | -28   | 29        | 23     | 4640                   | 23               | 96                     | 910           | 1.0          | 1075               | 160                             | 2.4                  | 0.4            | 0.31                       | 0.40 |
| Lac-Mégantic          | 420      | -27                | -29   | 27        | 22     | 5180                   | 23               | 91                     | 790           | 0.9          | 1025               | 160                             | 3.2                  | 0.6            | 0.27                       | 0.35 |
| La Malbaie            | 25       | -26                | -28   | 28        | 21     | 5400                   | 18               | 102                    | 640           | 0.8          | 900                | 180                             | 3.1                  | 0.6            | 0.37                       | 0.48 |
| La Pocatière          | 55       | -24                | -26   | 28        | 22     | 5160                   | 18               | 102                    | 675           | 0.9          | 965                | 180                             | 3.2                  | 0.6            | 0.39                       | 0.50 |
| La Tuque              | 165      | -30                | -32   | 29        | 22     | 5500                   | 23               | 96                     | 720           | 0.9          | 930                | 160                             | 3.4                  | 0.4            | 0.27                       | 0.35 |
| Lennoxville           | 155      | -28                | -30   | 29        | 22     | 4700                   | 23               | 96                     | 850           | 1.0          | 1100               | 160                             | 2.1                  | 0.6            | 0.25                       | 0.32 |
| Léry                  | 30       | -24                | -26   | 29        | 23     | 4420                   | 23               | 91                     | 800           | 0.9          | 950                | 180                             | 2.3                  | 0.4            | 0.33                       | 0.42 |
| Loretteville          | 100      | -26                | -29   | 28        | 22     | 5200                   | 20               | 102                    | 980           | 1.1          | 1225               | 200                             | 3.7                  | 0.6            | 0.32                       | 0.41 |
| Louiseville           | 15       | -25                | -28   | 29        | 23     | 4900                   | 20               | 102                    | 800           | 0.9          | 1025               | 160                             | 2.9                  | 0.4            | 0.34                       | 0.43 |
| Magog                 | 215      | -26                | -28   | 29        | 23     | 4730                   | 23               | 96                     | 860           | 1.0          | 1125               | 160                             | 2.3                  | 0.4            | 0.27                       | 0.35 |
| Malartic              | 325      | -33                | -36   | 29        | 21     | 6200                   | 20               | 86                     | 640           | 0.8          | 900                | 100                             | 3.3                  | 0.3            | 0.25                       | 0.32 |
| Maniwaki              | 180      | -30                | -32   | 29        | 22     | 5280                   | 23               | 96                     | 700           | 0.9          | 900                | 100                             | 2.4                  | 0.4            | 0.24                       | 0.31 |
| Masson                | 50       | -26                | -28   | 30        | 23     | 4610                   | 23               | 91                     | 790           | 0.9          | 975                | 160                             | 2.4                  | 0.4            | 0.31                       | 0.40 |
| Matane                | 5        | -24                | -26   | 24        | 20     | 5510                   | 18               | 91                     | 640           | 0.9          | 1050               | 220                             | 3.7                  | 0.4            | 0.43                       | 0.55 |
| Mont-Joli             | 90       | -24                | -26   | 26        | 21     | 5370                   | 18               | 91                     | 610           | 0.8          | 920                | 220                             | 4.1                  | 0.4            | 0.41                       | 0.52 |
| Mont-Laurier          | 225      | -29                | -32   | 29        | 22     | 5320                   | 24               | 102                    | 790           | 0.9          | 1000               | 160                             | 2.6                  | 0.4            | 0.23                       | 0.30 |
| Montmagny             | 10       | -25                | -28   | 28        | 22     | 5090                   | 20               | 102                    | 880           | 1.0          | 1090               | 180                             | 2.9                  | 0.6            | 0.37                       | 0.47 |

Table C-2 (Continued)

| Province and Location   | Elev., m | Design Temperature |       |           |        | Degree-Days Below 18°C | 15 Min. Rain, mm | One Day Rain, 1/50, mm | Ann. Rain, mm | Moist. Index | Ann. Tot. Ppn., mm | Driving Wind Pressures, Pa, 1/5 | Snow Load, kPa, 1/50 |                | Hourly Wind Pressures, kPa |      |
|-------------------------|----------|--------------------|-------|-----------|--------|------------------------|------------------|------------------------|---------------|--------------|--------------------|---------------------------------|----------------------|----------------|----------------------------|------|
|                         |          | January            |       | July 2.5% |        |                        |                  |                        |               |              |                    |                                 | S <sub>s</sub>       | S <sub>r</sub> | 1/10                       | 1/50 |
|                         |          | 2.5% °C            | 1% °C | Dry °C    | Wet °C |                        |                  |                        |               |              |                    |                                 |                      |                |                            |      |
| Montréal Region         |          |                    |       |           |        |                        |                  |                        |               |              |                    |                                 |                      |                |                            |      |
| Beaconsfield            | 25       | -24                | -26   | 30        | 23     | 4440                   | 23               | 91                     | 780           | 0.9          | 950                | 180                             | 2.3                  | 0.4            | 0.33                       | 0.42 |
| Dorval                  | 25       | -24                | -26   | 30        | 23     | 4400                   | 23               | 91                     | 760           | 0.9          | 940                | 180                             | 2.4                  | 0.4            | 0.34                       | 0.44 |
| Laval                   | 35       | -24                | -26   | 29        | 23     | 4500                   | 23               | 96                     | 830           | 0.9          | 1025               | 160                             | 2.6                  | 0.4            | 0.33                       | 0.42 |
| Montréal (City Hall)    | 20       | -23                | -26   | 30        | 23     | 4200                   | 23               | 96                     | 830           | 0.93         | 1025               | 180                             | 2.6                  | 0.4            | 0.34                       | 0.44 |
| Montréal-Est            | 25       | -23                | -26   | 30        | 23     | 4470                   | 23               | 96                     | 830           | 0.93         | 1025               | 180                             | 2.7                  | 0.4            | 0.34                       | 0.44 |
| Montréal-Nord           | 20       | -24                | -26   | 30        | 23     | 4470                   | 23               | 96                     | 830           | 0.93         | 1025               | 160                             | 2.6                  | 0.4            | 0.33                       | 0.42 |
| Outremont               | 105      | -23                | -26   | 30        | 23     | 4300                   | 23               | 96                     | 820           | 0.91         | 1025               | 180                             | 2.8                  | 0.4            | 0.34                       | 0.44 |
| Pierrefonds             | 25       | -24                | -26   | 30        | 23     | 4430                   | 23               | 96                     | 800           | 0.90         | 960                | 180                             | 2.4                  | 0.4            | 0.33                       | 0.42 |
| Sainte-Anne-de-Bellevue | 35       | -24                | -26   | 29        | 23     | 4460                   | 23               | 96                     | 780           | 0.9          | 960                | 180                             | 2.3                  | 0.4            | 0.33                       | 0.42 |
| Saint-Lambert           | 15       | -23                | -26   | 30        | 23     | 4400                   | 23               | 96                     | 810           | 0.91         | 1050               | 160                             | 2.5                  | 0.4            | 0.34                       | 0.44 |
| Saint-Laurent           | 45       | -23                | -26   | 30        | 23     | 4270                   | 23               | 96                     | 790           | 0.89         | 950                | 160                             | 2.5                  | 0.4            | 0.34                       | 0.44 |
| Verdun                  | 20       | -23                | -26   | 30        | 23     | 4200                   | 23               | 91                     | 780           | 0.9          | 1025               | 180                             | 2.5                  | 0.4            | 0.34                       | 0.44 |
| Nicolet (Gentilly)      | 15       | -25                | -28   | 29        | 23     | 4900                   | 20               | 107                    | 860           | 1.0          | 1025               | 160                             | 2.8                  | 0.4            | 0.33                       | 0.42 |
| Nitchequon              | 545      | -39                | -41   | 23        | 19     | 8100                   | 15               | 70                     | 500           | 0.9          | 825                | 140                             | 3.5                  | 0.3            | 0.29                       | 0.37 |
| Noranda                 | 305      | -33                | -36   | 29        | 21     | 6050                   | 20               | 91                     | 650           | 0.8          | 875                | 100                             | 3.2                  | 0.3            | 0.27                       | 0.35 |
| Percé                   | 5        | -21                | -24   | 25        | 19     | 5400                   | 16               | 107                    | 1000          | 1.2          | 1300               | 300                             | 3.8                  | 0.6            | 0.49                       | 0.63 |
| Pincourt                | 25       | -24                | -26   | 29        | 23     | 4480                   | 23               | 96                     | 780           | 0.9          | 950                | 180                             | 2.3                  | 0.4            | 0.33                       | 0.42 |
| Plessisville            | 145      | -26                | -28   | 29        | 23     | 5100                   | 21               | 107                    | 890           | 1.0          | 1150               | 180                             | 2.8                  | 0.6            | 0.27                       | 0.35 |
| Port-Cartier            | 20       | -28                | -30   | 25        | 19     | 6060                   | 15               | 106                    | 730           | 1.0          | 1125               | 300                             | 4.1                  | 0.4            | 0.42                       | 0.54 |
| Puvirnituq              | 5        | -36                | -38   | 23        | 16     | 9200                   | 7                | 54                     | 210           | 0.9          | 375                | 240                             | 4.5                  | 0.2            | 0.47                       | 0.60 |
| Québec City Region      |          |                    |       |           |        |                        |                  |                        |               |              |                    |                                 |                      |                |                            |      |
| Ancienne-Lorette        | 35       | -25                | -28   | 28        | 23     | 5130                   | 20               | 102                    | 940           | 1.1          | 1200               | 200                             | 3.4                  | 0.6            | 0.32                       | 0.41 |
| Lévis                   | 50       | -25                | -28   | 28        | 22     | 5050                   | 20               | 107                    | 920           | 1.0          | 1200               | 160                             | 3.3                  | 0.6            | 0.32                       | 0.41 |
| Québec                  | 120      | -25                | -28   | 28        | 22     | 5080                   | 20               | 107                    | 925           | 1.0          | 1210               | 200                             | 3.6                  | 0.6            | 0.32                       | 0.41 |
| Sainte-Foy              | 115      | -25                | -28   | 28        | 23     | 5100                   | 20               | 107                    | 940           | 1.1          | 1200               | 180                             | 3.7                  | 0.6            | 0.32                       | 0.41 |
| Sillery                 | 10       | -25                | -28   | 28        | 23     | 5070                   | 20               | 107                    | 930           | 1.1          | 1200               | 200                             | 3.1                  | 0.6            | 0.32                       | 0.41 |

Table C-2 (Continued)

Table C-2 (Continued)

| Province and Location           | Elev., m | Design Temperature |       |           |        | Degree-Days Below 18°C | 15 Min. Rain, mm | One Day Rain, 1/50, mm | Ann. Rain, mm | Moist. Index | Ann. Tot. Ppn., mm | Driving Rain Wind Pressures, Pa, 1/5 | Snow Load, kPa, 1/50 |                | Hourly Wind Pressures, kPa |      |
|---------------------------------|----------|--------------------|-------|-----------|--------|------------------------|------------------|------------------------|---------------|--------------|--------------------|--------------------------------------|----------------------|----------------|----------------------------|------|
|                                 |          | January            |       | July 2.5% |        |                        |                  |                        |               |              |                    |                                      | S <sub>s</sub>       | S <sub>r</sub> | 1/10                       | 1/50 |
|                                 |          | 2.5% °C            | 1% °C | Dry °C    | Wet °C |                        |                  |                        |               |              |                    |                                      |                      |                |                            |      |
| Richmond                        | 150      | -25                | -27   | 29        | 22     | 4700                   | 23               | 96                     | 870           | 1.0          | 1060               | 160                                  | 2.4                  | 0.6            | 0.25                       | 0.32 |
| Rimouski                        | 30       | -25                | -27   | 26        | 20     | 5300                   | 18               | 91                     | 640           | 0.8          | 890                | 200                                  | 3.8                  | 0.4            | 0.41                       | 0.52 |
| Rivière-du-Loup                 | 55       | -25                | -27   | 26        | 21     | 5380                   | 18               | 91                     | 660           | 0.8          | 900                | 180                                  | 3.5                  | 0.6            | 0.39                       | 0.50 |
| Roberval                        | 100      | -31                | -33   | 28        | 21     | 5750                   | 22               | 91                     | 590           | 0.8          | 910                | 140                                  | 3.5                  | 0.3            | 0.27                       | 0.35 |
| Rock Island                     | 160      | -25                | -27   | 29        | 23     | 4850                   | 23               | 91                     | 900           | 1.0          | 1125               | 160                                  | 2.0                  | 0.4            | 0.27                       | 0.35 |
| Rosemère                        | 25       | -24                | -26   | 29        | 23     | 4550                   | 23               | 96                     | 840           | 1.0          | 1050               | 160                                  | 2.6                  | 0.4            | 0.31                       | 0.40 |
| Rouyn                           | 300      | -33                | -36   | 29        | 21     | 6050                   | 20               | 91                     | 650           | 0.8          | 900                | 100                                  | 3.1                  | 0.3            | 0.27                       | 0.35 |
| Saguenay                        | 10       | -30                | -32   | 28        | 22     | 5700                   | 18               | 86                     | 710           | 0.9          | 975                | 140                                  | 2.7                  | 0.4            | 0.28                       | 0.36 |
| Saguenay (Bagotville)           | 5        | -31                | -33   | 28        | 21     | 5700                   | 18               | 86                     | 690           | 0.9          | 925                | 160                                  | 2.7                  | 0.4            | 0.30                       | 0.38 |
| Saguenay (Jonquière)            | 135      | -30                | -32   | 28        | 22     | 5650                   | 18               | 86                     | 710           | 0.9          | 925                | 160                                  | 3.1                  | 0.4            | 0.27                       | 0.35 |
| Saguenay (Kénogami)             | 140      | -30                | -32   | 28        | 22     | 5650                   | 18               | 86                     | 690           | 0.9          | 925                | 160                                  | 3.1                  | 0.4            | 0.27                       | 0.35 |
| Sainte-Agathe-des-Monts         | 360      | -28                | -30   | 28        | 22     | 5390                   | 23               | 96                     | 820           | 1.0          | 1170               | 140                                  | 3.4                  | 0.4            | 0.27                       | 0.35 |
| Saint-Eustache                  | 35       | -25                | -27   | 29        | 23     | 4500                   | 23               | 96                     | 820           | 0.9          | 1025               | 160                                  | 2.4                  | 0.4            | 0.29                       | 0.37 |
| Saint-Félicien                  | 105      | -32                | -34   | 28        | 22     | 5850                   | 22               | 91                     | 570           | 0.8          | 900                | 140                                  | 3.5                  | 0.3            | 0.27                       | 0.35 |
| Saint-Georges-de-Cacouna        | 35       | -25                | -27   | 26        | 21     | 5400                   | 18               | 91                     | 660           | 0.9          | 925                | 180                                  | 3.2                  | 0.6            | 0.39                       | 0.50 |
| Saint-Hubert                    | 25       | -24                | -26   | 30        | 23     | 4490                   | 23               | 91                     | 820           | 0.9          | 1020               | 180                                  | 2.5                  | 0.4            | 0.34                       | 0.44 |
| Saint-Hubert-de-Rivière-du-Loup | 310      | -26                | -28   | 26        | 21     | 5520                   | 22               | 91                     | 740           | 0.9          | 1025               | 180                                  | 4.4                  | 0.6            | 0.31                       | 0.40 |
| Saint-Hyacinthe                 | 35       | -24                | -27   | 30        | 23     | 4500                   | 21               | 91                     | 840           | 1.0          | 1030               | 160                                  | 2.3                  | 0.4            | 0.27                       | 0.35 |
| Saint-Jean-sur-Richelieu        | 35       | -24                | -26   | 29        | 23     | 4450                   | 23               | 91                     | 880           | 1.0          | 1010               | 180                                  | 2.2                  | 0.4            | 0.32                       | 0.41 |
| Saint-Jérôme                    | 95       | -26                | -28   | 29        | 23     | 4820                   | 23               | 96                     | 830           | 1.0          | 1025               | 160                                  | 2.7                  | 0.4            | 0.29                       | 0.37 |
| Saint-Jovite                    | 230      | -29                | -31   | 28        | 22     | 5250                   | 23               | 96                     | 810           | 1.0          | 1025               | 160                                  | 2.8                  | 0.4            | 0.26                       | 0.33 |
| Saint-Lazare / Hudson           | 60       | -24                | -26   | 30        | 23     | 4520                   | 23               | 96                     | 750           | 0.9          | 950                | 180                                  | 2.3                  | 0.4            | 0.33                       | 0.42 |
| Saint-Nicolas                   | 65       | -25                | -28   | 28        | 22     | 4990                   | 20               | 102                    | 890           | 1.0          | 1200               | 200                                  | 3.5                  | 0.6            | 0.33                       | 0.42 |
| Salaberry-de-Valleyfield        | 50       | -23                | -25   | 29        | 23     | 4400                   | 23               | 96                     | 760           | 0.9          | 900                | 180                                  | 2.3                  | 0.4            | 0.33                       | 0.42 |

Table C-2 (Continued)

Table C-2 (Continued)

| Province and Location | Elev., m | Design Temperature |       |           |        | Degree-Days Below 18°C | 15 Min. Rain, mm | One Day Rain, 1/50, mm | Ann. Rain, mm | Moist. Index | Ann. Tot. Ppn., mm | Driving Wind Pressures, Pa, 1/5 | Snow Load, kPa, 1/50 |                | Hourly Wind Pressures, kPa |      |
|-----------------------|----------|--------------------|-------|-----------|--------|------------------------|------------------|------------------------|---------------|--------------|--------------------|---------------------------------|----------------------|----------------|----------------------------|------|
|                       |          | January            |       | July 2.5% |        |                        |                  |                        |               |              |                    |                                 | S <sub>s</sub>       | S <sub>r</sub> | 1/10                       | 1/50 |
|                       |          | 2.5% °C            | 1% °C | Dry °C    | Wet °C |                        |                  |                        |               |              |                    |                                 |                      |                |                            |      |
| Schefferville         | 550      | -37                | -39   | 24        | 16     | 8550                   | 13               | 64                     | 410           | 0.8          | 800                | 180                             | 4.5                  | 0.3            | 0.33                       | 0.42 |
| Senneterre            | 310      | -34                | -36   | 29        | 21     | 6180                   | 22               | 91                     | 740           | 0.9          | 925                | 100                             | 3.3                  | 0.3            | 0.25                       | 0.32 |
| Sept-Îles             | 5        | -29                | -31   | 24        | 18     | 6200                   | 15               | 106                    | 760           | 1.0          | 1125               | 300                             | 4.1                  | 0.4            | 0.42                       | 0.54 |
| Shawinigan            | 60       | -26                | -29   | 29        | 23     | 5050                   | 22               | 102                    | 820           | 1.0          | 1050               | 180                             | 3.1                  | 0.4            | 0.27                       | 0.35 |
| Shawville             | 170      | -27                | -30   | 30        | 23     | 4880                   | 23               | 96                     | 670           | 0.8          | 880                | 160                             | 2.8                  | 0.4            | 0.27                       | 0.35 |
| Sherbrooke            | 185      | -28                | -30   | 29        | 23     | 4700                   | 23               | 96                     | 900           | 1.0          | 1100               | 160                             | 2.2                  | 0.6            | 0.25                       | 0.32 |
| Sorel                 | 10       | -25                | -27   | 29        | 23     | 4550                   | 20               | 102                    | 800           | 0.9          | 975                | 180                             | 2.8                  | 0.4            | 0.34                       | 0.43 |
| Sutton                | 185      | -25                | -27   | 29        | 23     | 4600                   | 23               | 96                     | 990           | 1.1          | 1260               | 160                             | 2.4                  | 0.4            | 0.29                       | 0.37 |
| Tadoussac             | 65       | -26                | -28   | 27        | 21     | 5450                   | 18               | 96                     | 700           | 0.9          | 1000               | 180                             | 3.7                  | 0.4            | 0.41                       | 0.52 |
| Témiscaming           | 240      | -30                | -32   | 30        | 22     | 5020                   | 23               | 96                     | 730           | 0.9          | 940                | 100                             | 2.5                  | 0.4            | 0.25                       | 0.32 |
| Terrebonne            | 20       | -25                | -27   | 29        | 23     | 4500                   | 23               | 96                     | 830           | 0.9          | 1025               | 160                             | 2.6                  | 0.4            | 0.31                       | 0.40 |
| Theftord Mines        | 330      | -26                | -28   | 28        | 22     | 5120                   | 22               | 107                    | 950           | 1.1          | 1230               | 160                             | 3.5                  | 0.6            | 0.27                       | 0.35 |
| Thurso                | 50       | -26                | -28   | 30        | 23     | 4820                   | 23               | 91                     | 800           | 0.9          | 950                | 160                             | 2.4                  | 0.4            | 0.31                       | 0.40 |
| Trois-Rivières        | 25       | -25                | -28   | 29        | 23     | 4900                   | 20               | 107                    | 860           | 1.0          | 1050               | 180                             | 2.8                  | 0.4            | 0.34                       | 0.43 |
| Val-d'Or              | 310      | -33                | -36   | 29        | 21     | 6180                   | 20               | 86                     | 640           | 0.8          | 925                | 100                             | 3.4                  | 0.3            | 0.25                       | 0.32 |
| Varennes              | 15       | -24                | -26   | 30        | 23     | 4500                   | 23               | 96                     | 810           | 0.9          | 1000               | 160                             | 2.6                  | 0.4            | 0.31                       | 0.40 |
| Verchères             | 15       | -24                | -26   | 30        | 23     | 4450                   | 23               | 96                     | 810           | 0.9          | 1000               | 160                             | 2.7                  | 0.4            | 0.34                       | 0.43 |
| Victoriaville         | 125      | -26                | -28   | 29        | 23     | 4900                   | 21               | 102                    | 850           | 1.0          | 1100               | 180                             | 2.6                  | 0.6            | 0.27                       | 0.35 |
| Ville-Marie           | 200      | -31                | -34   | 30        | 22     | 5550                   | 23               | 96                     | 630           | 0.8          | 825                | 120                             | 2.3                  | 0.4            | 0.31                       | 0.40 |
| Wakefield             | 120      | -27                | -30   | 30        | 23     | 4820                   | 23               | 91                     | 780           | 0.9          | 1020               | 160                             | 2.4                  | 0.4            | 0.27                       | 0.34 |
| Waterloo              | 205      | -25                | -27   | 29        | 23     | 4650                   | 23               | 96                     | 980           | 1.1          | 1250               | 160                             | 2.5                  | 0.4            | 0.27                       | 0.35 |
| Windsor               | 150      | -25                | -27   | 29        | 23     | 4700                   | 23               | 96                     | 930           | 1.0          | 1075               | 160                             | 2.3                  | 0.4            | 0.25                       | 0.32 |
| <b>New Brunswick</b>  |          |                    |       |           |        |                        |                  |                        |               |              |                    |                                 |                      |                |                            |      |
| Alma                  | 5        | -21                | -23   | 26        | 20     | 4500                   | 18               | 144                    | 1175          | 1.3          | 1450               | 260                             | 2.6                  | 0.6            | 0.37                       | 0.48 |
| Bathurst              | 10       | -23                | -26   | 30        | 22     | 5020                   | 20               | 106                    | 775           | 0.9          | 1020               | 180                             | 4.1                  | 0.6            | 0.37                       | 0.48 |
| Boiestown             | 65       | -25                | -28   | 29        | 21     | 4900                   | 20               | 96                     | 800           | 0.9          | 1075               | 180                             | 3.6                  | 0.6            | 0.30                       | 0.39 |
| Campbellton           | 30       | -26                | -28   | 29        | 22     | 5500                   | 20               | 107                    | 725           | 0.9          | 1025               | 180                             | 4.3                  | 0.4            | 0.35                       | 0.45 |

Table C-2 (Continued)

Table C-2 (Continued)

| Province and Location | Elev., m | Design Temperature |       |           |        | Degree-Days Below 18°C | 15 Min. Rain, mm | One Day Rain, 1/50, mm | Ann. Rain, mm | Moist. Index | Ann. Tot. Ppn., mm | Driving Wind Pressures, Pa, 1/5 | Snow Load, kPa, 1/50 |                | Hourly Wind Pressures, kPa |      |
|-----------------------|----------|--------------------|-------|-----------|--------|------------------------|------------------|------------------------|---------------|--------------|--------------------|---------------------------------|----------------------|----------------|----------------------------|------|
|                       |          | January            |       | July 2.5% |        |                        |                  |                        |               |              |                    |                                 | S <sub>s</sub>       | S <sub>r</sub> | 1/10                       | 1/50 |
|                       |          | 2.5% °C            | 1% °C | Dry °C    | Wet °C |                        |                  |                        |               |              |                    |                                 |                      |                |                            |      |
| Edmundston            | 160      | -27                | -29   | 28        | 22     | 5320                   | 23               | 91                     | 750           | 0.9          | 1000               | 160                             | 3.4                  | 0.6            | 0.30                       | 0.38 |
| Fredericton           | 15       | -24                | -27   | 29        | 22     | 4670                   | 22               | 112                    | 900           | 1.0          | 1100               | 160                             | 3.1                  | 0.6            | 0.30                       | 0.38 |
| Gagetown              | 20       | -24                | -26   | 29        | 22     | 4460                   | 20               | 112                    | 900           | 1.0          | 1125               | 180                             | 2.8                  | 0.6            | 0.31                       | 0.40 |
| Grand Falls           | 115      | -27                | -30   | 28        | 22     | 5300                   | 23               | 107                    | 850           | 1.0          | 1100               | 160                             | 3.6                  | 0.6            | 0.30                       | 0.38 |
| Miramichi             | 5        | -24                | -26   | 30        | 22     | 4950                   | 20               | 96                     | 825           | 1.0          | 1050               | 200                             | 3.4                  | 0.6            | 0.32                       | 0.41 |
| Moncton               | 20       | -23                | -25   | 28        | 21     | 4680                   | 20               | 112                    | 850           | 1.0          | 1175               | 220                             | 3.0                  | 0.6            | 0.39                       | 0.50 |
| Oromocto              | 20       | -24                | -26   | 29        | 22     | 4650                   | 22               | 112                    | 900           | 1.0          | 1110               | 160                             | 3.0                  | 0.6            | 0.30                       | 0.39 |
| Sackville             | 15       | -22                | -24   | 27        | 21     | 4590                   | 18               | 112                    | 975           | 1.1          | 1175               | 220                             | 2.5                  | 0.6            | 0.38                       | 0.49 |
| Saint Andrews         | 35       | -22                | -24   | 25        | 20     | 4680                   | 19               | 123                    | 1000          | 1.2          | 1200               | 220                             | 2.8                  | 0.6            | 0.35                       | 0.45 |
| Saint John            | 5        | -22                | -24   | 25        | 20     | 4570                   | 18               | 139                    | 1100          | 1.3          | 1425               | 260                             | 2.3                  | 0.6            | 0.41                       | 0.53 |
| Shippagan             | 5        | -22                | -24   | 28        | 21     | 4930                   | 18               | 96                     | 800           | 1.0          | 1050               | 260                             | 3.4                  | 0.6            | 0.49                       | 0.63 |
| St. George            | 35       | -21                | -23   | 25        | 20     | 4680                   | 18               | 123                    | 1000          | 1.2          | 1200               | 220                             | 2.8                  | 0.6            | 0.35                       | 0.45 |
| St. Stephen           | 20       | -24                | -26   | 28        | 22     | 4700                   | 20               | 123                    | 1000          | 1.2          | 1160               | 180                             | 2.9                  | 0.6            | 0.33                       | 0.42 |
| Woodstock             | 60       | -26                | -29   | 30        | 22     | 4910                   | 22               | 107                    | 875           | 1.0          | 1100               | 160                             | 3.1                  | 0.6            | 0.29                       | 0.37 |
| <b>Nova Scotia</b>    |          |                    |       |           |        |                        |                  |                        |               |              |                    |                                 |                      |                |                            |      |
| Amherst               | 25       | -21                | -24   | 27        | 21     | 4500                   | 18               | 118                    | 950           | 1.1          | 1150               | 220                             | 2.4                  | 0.6            | 0.37                       | 0.48 |
| Antigonish            | 10       | -17                | -20   | 27        | 21     | 4510                   | 15               | 123                    | 1100          | 1.3          | 1250               | 240                             | 2.3                  | 0.6            | 0.42                       | 0.54 |
| Bridgewater           | 10       | -15                | -17   | 27        | 20     | 4140                   | 16               | 144                    | 1300          | 1.5          | 1475               | 260                             | 1.9                  | 0.6            | 0.43                       | 0.55 |
| Canso                 | 5        | -13                | -15   | 25        | 20     | 4400                   | 15               | 123                    | 1325          | 1.5          | 1400               | 260                             | 1.7                  | 0.6            | 0.48                       | 0.61 |
| Debert                | 45       | -21                | -24   | 27        | 21     | 4500                   | 18               | 118                    | 1000          | 1.2          | 1200               | 240                             | 2.1                  | 0.6            | 0.37                       | 0.48 |
| Digby                 | 35       | -15                | -17   | 25        | 20     | 4020                   | 15               | 130                    | 1100          | 1.3          | 1275               | 260                             | 2.2                  | 0.6            | 0.43                       | 0.55 |
| Greenwood (CFB)       | 28       | -18                | -20   | 29        | 22     | 4140                   | 16               | 118                    | 925           | 1.1          | 1100               | 280                             | 2.7                  | 0.6            | 0.42                       | 0.54 |
| <b>Halifax Region</b> |          |                    |       |           |        |                        |                  |                        |               |              |                    |                                 |                      |                |                            |      |
| Dartmouth             | 10       | -16                | -18   | 26        | 20     | 4100                   | 18               | 144                    | 1250          | 1.4          | 1400               | 280                             | 1.6                  | 0.6            | 0.45                       | 0.58 |
| Halifax               | 55       | -16                | -18   | 26        | 20     | 4000                   | 17               | 150                    | 1350          | 1.5          | 1500               | 280                             | 1.9                  | 0.6            | 0.45                       | 0.58 |
| Kentville             | 25       | -18                | -20   | 28        | 21     | 4130                   | 17               | 118                    | 950           | 1.1          | 1200               | 260                             | 2.6                  | 0.6            | 0.42                       | 0.54 |
| Liverpool             | 20       | -16                | -18   | 27        | 20     | 3990                   | 16               | 150                    | 1325          | 1.5          | 1425               | 280                             | 1.7                  | 0.6            | 0.48                       | 0.61 |

Table C-2 (Continued)

Table C-2 (Continued)

| Province and Location            | Elev., m | Design Temperature |      |           |        | Degree-Days Below 18°C | 15 Min. Rain, mm | One Day Rain, 1/50, mm | Ann. Rain, mm | Moist. Index | Ann. Tot. Ppr., mm | Driving Rain Wind Pressures, Pa, 1/5 | Snow Load, kPa, 1/50 |                | Hourly Wind Pressures, kPa |      |
|----------------------------------|----------|--------------------|------|-----------|--------|------------------------|------------------|------------------------|---------------|--------------|--------------------|--------------------------------------|----------------------|----------------|----------------------------|------|
|                                  |          | January            |      | July 2.5% |        |                        |                  |                        |               |              |                    |                                      | S <sub>s</sub>       | S <sub>t</sub> | 1/10                       | 1/50 |
|                                  |          | 2.5°C              | 1%°C | Dry °C    | Wet °C |                        |                  |                        |               |              |                    |                                      |                      |                |                            |      |
| Lockeport                        | 5        | -14                | -16  | 25        | 20     | 4000                   | 18               | 139                    | 1250          | 1.4          | 1450               | 280                                  | 1.4                  | 0.6            | 0.47                       | 0.60 |
| Louisbourg                       | 5        | -15                | -17  | 26        | 20     | 4530                   | 15               | 118                    | 1300          | 1.5          | 1500               | 300                                  | 2.1                  | 0.7            | 0.51                       | 0.65 |
| Lunenburg                        | 25       | -15                | -17  | 26        | 20     | 4140                   | 16               | 144                    | 1300          | 1.5          | 1450               | 260                                  | 1.9                  | 0.6            | 0.48                       | 0.61 |
| New Glasgow                      | 30       | -19                | -21  | 27        | 21     | 4320                   | 15               | 135                    | 975           | 1.1          | 1200               | 260                                  | 2.2                  | 0.6            | 0.43                       | 0.55 |
| North Sydney                     | 20       | -16                | -19  | 27        | 21     | 4500                   | 15               | 123                    | 1200          | 1.4          | 1475               | 300                                  | 2.4                  | 0.6            | 0.46                       | 0.59 |
| Pictou                           | 25       | -19                | -21  | 27        | 21     | 4310                   | 15               | 107                    | 950           | 1.1          | 1175               | 260                                  | 2.2                  | 0.6            | 0.43                       | 0.55 |
| Port Hawkesbury                  | 40       | -17                | -19  | 27        | 21     | 4500                   | 15               | 128                    | 1325          | 1.5          | 1450               | 260                                  | 2.1                  | 0.6            | 0.48                       | 0.61 |
| Springhill                       | 185      | -20                | -23  | 27        | 21     | 4540                   | 18               | 118                    | 1075          | 1.2          | 1175               | 220                                  | 3.1                  | 0.6            | 0.37                       | 0.48 |
| Stewiacke                        | 25       | -20                | -22  | 27        | 21     | 4400                   | 18               | 128                    | 1050          | 1.2          | 1250               | 240                                  | 1.8                  | 0.6            | 0.39                       | 0.50 |
| Sydney                           | 5        | -16                | -19  | 27        | 21     | 4530                   | 15               | 123                    | 1200          | 1.4          | 1475               | 300                                  | 2.3                  | 0.6            | 0.46                       | 0.59 |
| Tatamagouche                     | 25       | -20                | -23  | 27        | 21     | 4380                   | 18               | 118                    | 875           | 1.1          | 1150               | 260                                  | 2.2                  | 0.6            | 0.43                       | 0.55 |
| Truro                            | 25       | -20                | -22  | 27        | 21     | 4500                   | 18               | 118                    | 1000          | 1.2          | 1175               | 240                                  | 2.0                  | 0.6            | 0.37                       | 0.48 |
| Wolfville                        | 35       | -19                | -21  | 28        | 21     | 4140                   | 17               | 118                    | 975           | 1.1          | 1175               | 260                                  | 2.6                  | 0.6            | 0.42                       | 0.54 |
| Yarmouth                         | 10       | -14                | -16  | 22        | 19     | 3990                   | 19               | 135                    | 1125          | 1.3          | 1260               | 280                                  | 1.8                  | 0.6            | 0.44                       | 0.56 |
| <b>Prince Edward Island</b>      |          |                    |      |           |        |                        |                  |                        |               |              |                    |                                      |                      |                |                            |      |
| Charlottetown                    | 5        | -20                | -22  | 26        | 21     | 4460                   | 16               | 107                    | 900           | 1.1          | 1150               | 350                                  | 2.7                  | 0.6            | 0.44                       | 0.56 |
| Souris                           | 5        | -19                | -21  | 27        | 21     | 4550                   | 15               | 112                    | 950           | 1.1          | 1130               | 350                                  | 2.7                  | 0.6            | 0.45                       | 0.58 |
| Summerside                       | 10       | -20                | -22  | 27        | 21     | 4600                   | 16               | 112                    | 825           | 1.0          | 1060               | 350                                  | 3.1                  | 0.6            | 0.47                       | 0.60 |
| Tignish                          | 10       | -20                | -22  | 27        | 21     | 4770                   | 16               | 96                     | 800           | 1.0          | 1100               | 350                                  | 3.2                  | 0.6            | 0.51                       | 0.66 |
| <b>Newfoundland and Labrador</b> |          |                    |      |           |        |                        |                  |                        |               |              |                    |                                      |                      |                |                            |      |
| Argentia                         | 15       | -12                | -14  | 21        | 18     | 4600                   | 15               | 107                    | 1250          | 1.5          | 1400               | 400                                  | 2.4                  | 0.7            | 0.59                       | 0.75 |
| Bonavista                        | 15       | -14                | -16  | 24        | 19     | 5000                   | 18               | 96                     | 825           | 1.1          | 1010               | 400                                  | 3.1                  | 0.6            | 0.66                       | 0.84 |
| Buchans                          | 255      | -24                | -27  | 27        | 20     | 5250                   | 13               | 107                    | 850           | 1.0          | 1125               | 200                                  | 4.7                  | 0.6            | 0.47                       | 0.60 |
| Cape Harrison                    | 5        | -29                | -31  | 26        | 16     | 6900                   | 10               | 106                    | 475           | 0.9          | 950                | 350                                  | 6.3                  | 0.4            | 0.47                       | 0.60 |
| Cape Race                        | 5        | -11                | -13  | 19        | 18     | 4900                   | 18               | 130                    | 1425          | 1.7          | 1550               | 400                                  | 2.3                  | 0.7            | 0.82                       | 1.05 |
| Channel-Port aux Basques         | 5        | -13                | -15  | 19        | 18     | 5000                   | 13               | 123                    | 1175          | 1.4          | 1520               | 450                                  | 3.6                  | 0.7            | 0.61                       | 0.78 |

Table C-2 (Continued)

Table C-2 (Continued)

| Province and Location        | Elev., m | Design Temperature    |                   |                     |                     | Degree-Days Below 18°C | 15 Min. Rain, mm | One Day Rain, 1/50, mm | Ann. Rain, mm | Moist. Index | Ann. Tot. Ppn., mm | Driving Wind Pressures, Pa, 1/5 | Snow Load, kPa, 1/50 |                | Hourly Wind Pressures, kPa |      |
|------------------------------|----------|-----------------------|-------------------|---------------------|---------------------|------------------------|------------------|------------------------|---------------|--------------|--------------------|---------------------------------|----------------------|----------------|----------------------------|------|
|                              |          | January 2.5%<br>2.5°C | January 1%<br>1°C | July 2.5%<br>Dry °C | July 2.5%<br>Wet °C |                        |                  |                        |               |              |                    |                                 | S <sub>s</sub>       | S <sub>r</sub> | 1/10                       | 1/50 |
| Comer Brook                  | 35       | -16                   | -18               | 26                  | 20                  | 4760                   | 13               | 91                     | 875           | 1.1          | 1190               | 300                             | 3.7                  | 0.6            | 0.43                       | 0.55 |
| Gander                       | 125      | -18                   | -20               | 27                  | 20                  | 5110                   | 18               | 91                     | 775           | 1.0          | 1180               | 280                             | 3.7                  | 0.6            | 0.47                       | 0.60 |
| Grand Bank                   | 5        | -14                   | -15               | 20                  | 18                  | 4550                   | 15               | 123                    | 1350          | 1.6          | 1525               | 400                             | 2.4                  | 0.7            | 0.58                       | 0.74 |
| Grand Falls                  | 60       | -26                   | -29               | 27                  | 20                  | 5020                   | 15               | 86                     | 775           | 1.0          | 1030               | 240                             | 3.4                  | 0.6            | 0.47                       | 0.60 |
| Happy Valley-Goose Bay       | 15       | -31                   | -32               | 27                  | 19                  | 6670                   | 18               | 80                     | 575           | 0.8          | 960                | 160                             | 5.3                  | 0.4            | 0.33                       | 0.42 |
| Labrador City                | 550      | -36                   | -38               | 24                  | 17                  | 7710                   | 15               | 70                     | 500           | 0.8          | 880                | 140                             | 4.8                  | 0.3            | 0.31                       | 0.40 |
| St. Anthony                  | 10       | -25                   | -27               | 22                  | 18                  | 6440                   | 13               | 86                     | 800           | 1.1          | 1280               | 450                             | 6.1                  | 0.6            | 0.68                       | 0.87 |
| Stephenville                 | 25       | -16                   | -18               | 24                  | 19                  | 4850                   | 14               | 102                    | 1000          | 1.2          | 1275               | 350                             | 4.1                  | 0.6            | 0.45                       | 0.58 |
| St. John's                   | 65       | -15                   | -16               | 24                  | 20                  | 4800                   | 18               | 118                    | 1200          | 1.4          | 1575               | 400                             | 2.9                  | 0.7            | 0.61                       | 0.78 |
| Twin Falls                   | 425      | -35                   | -37               | 24                  | 17                  | 7790                   | 15               | 70                     | 500           | 0.9          | 950                | 120                             | 4.8                  | 0.4            | 0.31                       | 0.40 |
| Wabana                       | 75       | -15                   | -17               | 24                  | 20                  | 4750                   | 18               | 112                    | 1125          | 1.3          | 1500               | 400                             | 3.0                  | 0.7            | 0.59                       | 0.75 |
| Wabush                       | 550      | -36                   | -38               | 24                  | 17                  | 7710                   | 15               | 70                     | 500           | 0.8          | 880                | 140                             | 4.8                  | 0.3            | 0.31                       | 0.40 |
| <b>Yukon</b>                 |          |                       |                   |                     |                     |                        |                  |                        |               |              |                    |                                 |                      |                |                            |      |
| Aishihik                     | 920      | -44                   | -46               | 23                  | 15                  | 7500                   | 8                | 43                     | 190           | 0.6          | 275                | 40                              | 1.9                  | 0.1            | 0.27                       | 0.38 |
| Dawson                       | 330      | -50                   | -51               | 26                  | 16                  | 8120                   | 10               | 49                     | 200           | 0.6          | 350                | 40                              | 2.9                  | 0.1            | 0.22                       | 0.31 |
| Destruction Bay              | 815      | -43                   | -45               | 23                  | 14                  | 7800                   | 8                | 49                     | 190           | 0.6          | 300                | 80                              | 1.9                  | 0.1            | 0.42                       | 0.60 |
| Faro                         | 670      | -46                   | -47               | 25                  | 16                  | 7300                   | 10               | 33                     | 215           | 0.6          | 315                | 40                              | 2.3                  | 0.1            | 0.26                       | 0.35 |
| Haines Junction              | 600      | -45                   | -47               | 24                  | 14                  | 7100                   | 8                | 51                     | 145           | 0.6          | 315                | 180                             | 2.2                  | 0.1            | 0.24                       | 0.34 |
| Snag                         | 595      | -51                   | -53               | 23                  | 16                  | 8300                   | 8                | 59                     | 290           | 0.6          | 350                | 40                              | 2.2                  | 0.1            | 0.22                       | 0.31 |
| Teslin                       | 690      | -42                   | -44               | 24                  | 15                  | 6770                   | 10               | 38                     | 200           | 0.5          | 340                | 40                              | 3.0                  | 0.1            | 0.26                       | 0.34 |
| Watson Lake                  | 685      | -46                   | -48               | 26                  | 16                  | 7470                   | 10               | 54                     | 250           | 0.6          | 410                | 60                              | 3.2                  | 0.1            | 0.26                       | 0.35 |
| Whitehorse                   | 655      | -41                   | -43               | 25                  | 15                  | 6580                   | 8                | 43                     | 170           | 0.5          | 275                | 40                              | 2.0                  | 0.1            | 0.29                       | 0.38 |
| <b>Northwest Territories</b> |          |                       |                   |                     |                     |                        |                  |                        |               |              |                    |                                 |                      |                |                            |      |
| Aklavik                      | 5        | -42                   | -44               | 26                  | 17                  | 9600                   | 6                | 49                     | 115           | 0.7          | 250                | 60                              | 2.8                  | 0.1            | 0.31                       | 0.40 |
| Behchokq / Rae-Edzo          | 160      | -42                   | -44               | 25                  | 17                  | 8300                   | 10               | 60                     | 175           | 0.6          | 275                | 80                              | 2.3                  | 0.1            | 0.31                       | 0.40 |
| Echo Bay / Port Radium       | 195      | -42                   | -44               | 22                  | 16                  | 9300                   | 8                | 60                     | 160           | 0.7          | 250                | 80                              | 3.0                  | 0.1            | 0.41                       | 0.53 |

Table C-2 (Continued)

Table C-2 (Continued)

| Province and Location             | Elev., m | Design Temperature |       |           |        | Degree-Days Below 18°C | 15 Min. Rain, mm | One Day Rain, 1/50, mm | Ann. Rain, mm | Moist. Index | Ann. Tot. Ppn., mm | Driving Wind Pressures, Pa, 1/5 | Snow Load, kPa, 1/50 |                | Hourly Wind Pressures, kPa |      |
|-----------------------------------|----------|--------------------|-------|-----------|--------|------------------------|------------------|------------------------|---------------|--------------|--------------------|---------------------------------|----------------------|----------------|----------------------------|------|
|                                   |          | January            |       | July 2.5% |        |                        |                  |                        |               |              |                    |                                 | S <sub>s</sub>       | S <sub>r</sub> | 1/10                       | 1/50 |
|                                   |          | 2.5% °C            | 1% °C | Dry °C    | Wet °C |                        |                  |                        |               |              |                    |                                 |                      |                |                            |      |
| Fort Good Hope                    | 100      | -43                | -45   | 28        | 18     | 8700                   | 9                | 60                     | 140           | 0.6          | 280                | 80                              | 2.9                  | 0.1            | 0.34                       | 0.44 |
| Fort McPherson                    | 25       | -44                | -46   | 26        | 17     | 9150                   | 6                | 50                     | 145           | 0.7          | 315                | 60                              | 3.2                  | 0.1            | 0.31                       | 0.40 |
| Fort Providence                   | 150      | -40                | -43   | 28        | 18     | 7620                   | 10               | 71                     | 210           | 0.6          | 350                | 100                             | 2.4                  | 0.1            | 0.27                       | 0.35 |
| Fort Resolution                   | 160      | -40                | -42   | 26        | 18     | 7750                   | 10               | 60                     | 175           | 0.6          | 300                | 140                             | 2.3                  | 0.1            | 0.30                       | 0.39 |
| Fort Simpson                      | 120      | -42                | -44   | 28        | 19     | 7660                   | 12               | 76                     | 225           | 0.6          | 360                | 80                              | 2.3                  | 0.1            | 0.30                       | 0.39 |
| Fort Smith                        | 205      | -41                | -43   | 28        | 19     | 7300                   | 10               | 65                     | 250           | 0.6          | 350                | 80                              | 2.3                  | 0.2            | 0.30                       | 0.39 |
| Hay River                         | 45       | -38                | -41   | 27        | 18     | 7550                   | 10               | 60                     | 200           | 0.6          | 325                | 140                             | 2.4                  | 0.1            | 0.27                       | 0.35 |
| Inuvik                            | 45       | -43                | -45   | 26        | 17     | 9600                   | 6                | 49                     | 115           | 0.7          | 425                | 60                              | 3.1                  | 0.1            | 0.31                       | 0.40 |
| Mould Bay                         | 5        | -44                | -46   | 11        | 8      | 12900                  | 3                | 33                     | 25            | 0.9          | 100                | 140                             | 1.5                  | 0.1            | 0.45                       | 0.58 |
| Norman Wells                      | 65       | -43                | -45   | 28        | 18     | 8510                   | 9                | 60                     | 165           | 0.6          | 320                | 80                              | 3.0                  | 0.1            | 0.34                       | 0.44 |
| Tungsten                          | 1340     | -49                | -51   | 26        | 16     | 7700                   | 10               | 44                     | 315           | 0.8          | 640                | 40                              | 4.3                  | 0.1            | 0.34                       | 0.44 |
| Ulukhaktok / Holman               | 10       | -39                | -41   | 18        | 12     | 10700                  | 3                | 44                     | 80            | 0.9          | 250                | 120                             | 2.1                  | 0.1            | 0.67                       | 0.86 |
| Wrigley                           | 80       | -42                | -44   | 28        | 18     | 8050                   | 10               | 54                     | 220           | 0.6          | 350                | 80                              | 2.8                  | 0.1            | 0.30                       | 0.39 |
| Yellowknife                       | 160      | -41                | -44   | 25        | 17     | 8170                   | 10               | 60                     | 175           | 0.6          | 275                | 100                             | 2.2                  | 0.1            | 0.31                       | 0.40 |
| <b>Nunavut</b>                    |          |                    |       |           |        |                        |                  |                        |               |              |                    |                                 |                      |                |                            |      |
| Alert                             | 5        | -43                | -44   | 13        | 8      | 13030                  | 3                | 22                     | 20            | 1.0          | 150                | 100                             | 2.6                  | 0.1            | 0.59                       | 0.75 |
| Arctic Bay                        | 15       | -42                | -44   | 14        | 10     | 11900                  | 3                | 38                     | 60            | 0.9          | 150                | 160                             | 2.4                  | 0.1            | 0.43                       | 0.55 |
| Arviat                            | 5        | -40                | -41   | 22        | 16     | 9850                   | 8                | 65                     | 225           | 0.9          | 300                | 240                             | 3.0                  | 0.2            | 0.45                       | 0.58 |
| Baker Lake                        | 5        | -42                | -44   | 23        | 15     | 10700                  | 5                | 55                     | 160           | 0.8          | 260                | 180                             | 3.4                  | 0.2            | 0.42                       | 0.54 |
| Eureka                            | 5        | -47                | -48   | 12        | 8      | 13500                  | 3                | 27                     | 25            | 1.0          | 70                 | 100                             | 1.6                  | 0.1            | 0.43                       | 0.55 |
| Igluigaariuk / Chesterfield Inlet | 10       | -40                | -41   | 20        | 14     | 10500                  | 5                | 60                     | 175           | 0.9          | 270                | 240                             | 3.6                  | 0.2            | 0.44                       | 0.56 |
| Iqaluit                           | 45       | -40                | -41   | 17        | 12     | 9980                   | 5                | 58                     | 200           | 0.9          | 433                | 200                             | 2.9                  | 0.2            | 0.51                       | 0.65 |
| Iqaluktuuttiaq / Cambridge Bay    | 15       | -41                | -44   | 18        | 13     | 11670                  | 4                | 38                     | 70            | 0.9          | 140                | 100                             | 1.9                  | 0.1            | 0.39                       | 0.50 |
| Isachsen                          | 10       | -46                | -48   | 12        | 9      | 13600                  | 3                | 27                     | 25            | 1.0          | 75                 | 140                             | 1.9                  | 0.1            | 0.47                       | 0.6  |
| Kangiqiniq / Rankin Inlet         | 10       | -41                | -42   | 21        | 15     | 10500                  | 5                | 65                     | 180           | 0.9          | 250                | 240                             | 3.0                  | 0.2            | 0.47                       | 0.6  |
| Kanniqtuqaapik / Clyde River      | 5        | -40                | -42   | 14        | 10     | 11300                  | 5                | 44                     | 55            | 0.9          | 225                | 220                             | 4.2                  | 0.2            | 0.43                       | 0.55 |

Table C-2 (Continued)

| Province and Location  | Elev., m | Design Temperature |      |       |         | Degree-Days Below 18°C | 15 Min. Rain, mm | One Day Rain, 1/50, mm | Ann. Rain, mm | Moist. Index | Ann. Tot. Ppn., mm | Driving Rain Wind Pres-sures, Pa, 1/5 | Snow Load, kPa, 1/50 |        | Hourly Wind Pressures, kPa |                |
|------------------------|----------|--------------------|------|-------|---------|------------------------|------------------|------------------------|---------------|--------------|--------------------|---------------------------------------|----------------------|--------|----------------------------|----------------|
|                        |          | January            | July | 1% °C | 2.5% °C |                        |                  |                        |               |              |                    |                                       | Dry °C               | Wet °C | S <sub>s</sub>             | S <sub>r</sub> |
| Kugluktuk / Coppermine | 10       | -41                | -43  | 23    | 16      | 10300                  | 6                | 65                     | 140           | 0.8          | 150                | 80                                    | 3.4                  | 0.1    | 0.36                       | 0.46           |
| Nottingham Island      | 30       | -37                | -39  | 16    | 13      | 10000                  | 5                | 54                     | 175           | 0.9          | 325                | 200                                   | 4.7                  | 0.2    | 0.61                       | 0.78           |
| Resolute               | 25       | -42                | -43  | 11    | 9       | 12360                  | 3                | 27                     | 50            | 0.9          | 140                | 180                                   | 2.0                  | 0.1    | 0.46                       | 0.59           |
| Resolution Island      | 5        | -32                | -34  | 12    | 10      | 9000                   | 5                | 71                     | 240           | 0.9          | 550                | 200                                   | 5.5                  | 0.2    | 0.96                       | 1.23           |
| Salliq / Coral Harbour | 15       | -41                | -42  | 20    | 14      | 10720                  | 5                | 65                     | 150           | 0.9          | 280                | 200                                   | 3.8                  | 0.2    | 0.45                       | 0.58           |

Table C-2 (Continued)

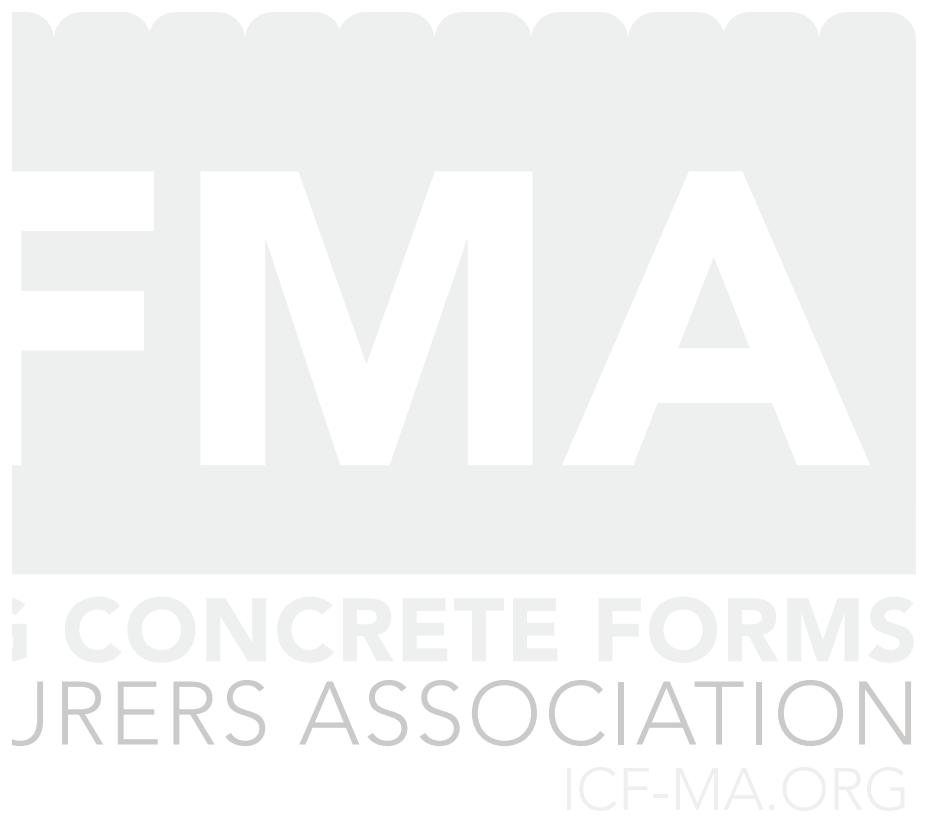







# The Insulating Concrete Forms Manufacturers Association Prescriptive ICF Design for Part 9 Structures in Canada Second Edition

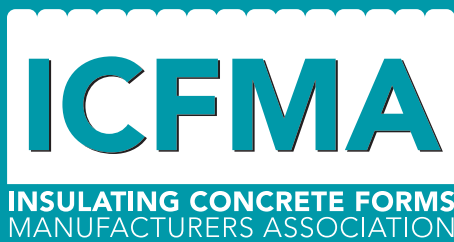

## THE INSULATING CONCRETE FORMS MANUFACTURERS ASSOCIATION

The Insulating Concrete Forms Manufacturers Association (ICFMA) is the North American non-profit trade association for the Insulated Concrete Form industry and was founded in 2014 by a dedicated group of manufacturers with the interest of improving the quality and acceptance of Insulated Concrete Form construction.

## MISSION

The mission of the ICFMA is to promote and enhance the social, environmental and economic value of insulating concrete forms in the North American marketplace.

[LEARN MORE ABOUT ICFS AT ICF-MA.ORG](https://www.icf-ma.org)



[QUADLOCK.COM](https://www.quadlock.com)



[NUDURA.COM](https://www.nudura.com)



[SUPERFORMICF.CA](https://www.superformicf.ca)



[ELEMENTICF.COM](https://www.elementicf.com)



[BUILDBLOCK.COM](https://www.buildblock.com)



[FOXBLOCKS.COM](https://www.foxblocks.com)



This engineering is only authorized for use by ICFMA Members. ©2024 All Rights Reserved.